

The Garmin logo, consisting of the word "GARMIN" in a bold, white, sans-serif font with a small white triangle above the letter "I".

GARMIN

A detailed, semi-transparent map of the Green Bay, Wisconsin area, showing various airports, roads, and geographical features. The map is overlaid on a dark background.

G1000[®] Integrated Flight Deck
Cockpit Reference Guide

A detailed, semi-transparent map of the Stevens Point, Wisconsin area, showing various airports, roads, and geographical features. The map is overlaid on a dark background.

Cessna
Nav III

SYSTEM OVERVIEW

FLIGHT INSTRUMENTS

ENGINE INDICATION SYSTEM

NAV/COM/TRANSPONDER

AUDIO PANEL

AUTOMATIC FLIGHT CONTROL

NAVIGATION

FLIGHT PLANNING

PROCEDURES

HAZARD AVOIDANCE

ADDITIONAL FEATURES

ABNORMAL OPERATIONS

ANNUNCIATIONS & ALERTS

INDEX

Copyright © 2004-2011 Garmin Ltd. or its subsidiaries. All rights reserved.

This manual reflects the operation of System Software version 0563.25 or later for Cessna 172R, 172S, 182T, T182T, 206H, and T206H aircraft. Some differences in operation may be observed when comparing the information in this manual to earlier or later software versions.

Garmin International, Inc., 1200 East 151st Street, Olathe, Kansas 66062, U.S.A.

Tel: 913/397.8200

Fax: 913/397.8282

Garmin AT, Inc., 2345 Turner Road SE, Salem, OR 97302, U.S.A.

Tel: 503/391.3411

Fax 503/364.2138

Garmin (Europe) Ltd, Liberty House, Bulls Copse Road, Hounsdown Business Park, Southampton, SO40 9RB, U.K.

Tel: 44/0870.8501241

Fax: 44/0870.8501251

Garmin Corporation, No. 68, Jangshu 2nd Road, Shijr, Taipei County, Taiwan

Tel: 886/02.2642.9199

Fax: 886/02.2642.9099

For after-hours emergency, aircraft on ground (AOG) technical support for Garmin panel mount and integrated avionics systems, please contact Garmin's AOG Hotline at 913.397.0836.

Web Site Address: www.garmin.com

Except as expressly provided herein, no part of this manual may be reproduced, copied, transmitted, disseminated, downloaded or stored in any storage medium, for any purpose without the express written permission of Garmin. Garmin hereby grants permission to download a single copy of this manual and of any revision to this manual onto a hard drive or other electronic storage medium to be viewed for personal use, provided that such electronic or printed copy of this manual or revision must contain the complete text of this copyright notice and provided further that any unauthorized commercial distribution of this manual or any revision hereto is strictly prohibited.

Garmin® and G1000® are registered trademarks of Garmin Ltd. or its subsidiaries. FliteCharts®, and SafeTaxi® are trademarks of Garmin Ltd. or its subsidiaries. These trademarks may not be used without the express permission of Garmin.

NavData® is a registered trademark of Jeppesen, Inc.; Stormscope® is a registered trademark of L-3 Communications; and SiriusXM® is a registered trademark of SiriusXM Satellite Radio, Inc.; Honeywell® and Bendix/King® are registered trademarks of Honeywell International, Inc.; CO Guardian is a trademark of CO Guardian, Inc.

AOPA Membership Publications, Inc. and its related organizations (hereinafter collectively "AOPA") expressly disclaim all warranties, with respect to the AOPA information included in this data, express or implied, including, but not limited to, the implied warranties of merchantability and fitness for a particular purpose. The information is provided "as is" and AOPA does not warrant or make any representations regarding its accuracy, reliability, or otherwise. Under no circumstances including negligence, shall AOPA be liable for any incidental, special or consequential damages that result from the use or inability to use the software or related documentation, even if AOPA or an AOPA authorized representative has been advised of the possibility of such damages. User agrees not to sue AOPA and, to the maximum extent allowed by law, to release and hold harmless AOPA from any causes of action, claims or losses related to any actual or alleged inaccuracies in the information. Some jurisdictions do not allow the limitation or exclusion of implied warranties or liability for incidental or consequential damages so the above limitations or exclusions may not apply to you.



WARNING: Navigation and terrain separation must NOT be predicated upon the use of the terrain avoidance feature. The terrain avoidance feature is NOT intended to be used as a primary reference for terrain avoidance and does not relieve the pilot from the responsibility of being aware of surroundings during flight. The terrain avoidance feature is only to be used as an aid for terrain avoidance. Terrain data is obtained from third party sources. Garmin is not able to independently verify the accuracy of the terrain data.



WARNING: The displayed minimum safe altitudes (MSAs) are only advisory in nature and should not be relied upon as the sole source of obstacle and terrain avoidance information. Always refer to current aeronautical charts for appropriate minimum clearance altitudes.



WARNING: The altitude calculated by G1000 GPS receivers is geometric height above Mean Sea Level and could vary significantly from the altitude displayed by pressure altimeters, such as the GDC 74A Air Data Computer, or other altimeters in the aircraft. GPS altitude should never be used for vertical navigation. Always use pressure altitude displayed by the G1000 PFD or other pressure altimeters in aircraft.



WARNING: Do not use outdated database information. Databases used in the G1000 system must be updated regularly in order to ensure that the information remains current. Pilots using any outdated database do so entirely at their own risk.



WARNING: Do not use basemap (land and water data) information for primary navigation. Basemap data is intended only to supplement other approved navigation data sources and should be considered as an aid to enhance situational awareness.



WARNING: Traffic information shown on system displays is provided as an aid in visually acquiring traffic. Pilots must maneuver the aircraft based only upon ATC guidance or positive visual acquisition of conflicting traffic.



WARNING: Use of the Stormscope is not intended for hazardous weather penetration (thunderstorm penetration). Stormscope information, as displayed on the G1000 MFD, is to be used only for weather avoidance, not penetration.



WARNING: Do not use datalink weather products (e.g., XM WX Satellite Weather, GFDS World Wide Weather, or FIS-B) for hazardous weather penetration. Weather information provided by these products is aged by up to several minutes and may not depict actual weather conditions as they currently appear.



WARNING: NEXRAD weather data is to be used for long-range planning purposes only. Due to inherent delays in data transmission and the relative age of the data, NEXRAD weather data should not be used for short-range weather avoidance.



WARNING: The Garmin G1000, as installed in Cessna Nav III aircraft, has a very high degree of functional integrity. However, the pilot must recognize that providing monitoring and/or self-test capability for all conceivable system failures is not practical. Although unlikely, it may be possible for erroneous operation to occur without a fault indication shown by the G1000. It is thus the responsibility of the pilot to detect such an occurrence by means of cross-checking with all redundant or correlated information available in the cockpit.



WARNING: For safety reasons, G1000 operational procedures must be learned on the ground.



WARNING: The United States government operates the Global Positioning System and is solely responsible for its accuracy and maintenance. The GPS system is subject to changes which could affect the accuracy and performance of all GPS equipment. Portions of the Garmin G1000 utilize GPS as a precision electronic NAVigation AID (NAVAID). Therefore, as with all NAVAIDs, information presented by the G1000 can be misused or misinterpreted and, therefore, become unsafe.



WARNING: To reduce the risk of unsafe operation, carefully review and understand all aspects of the G1000 Pilot's Guide documentation. Thoroughly practice basic operation prior to actual use. During flight operations, carefully compare indications from the G1000 to all available navigation sources, including the information from other NAVAIDs, visual sightings, charts, etc. For safety purposes, always resolve any discrepancies before continuing navigation.



WARNING: The illustrations in this guide are only examples. Never use the G1000 to attempt to penetrate a thunderstorm. Both the FAA Advisory Circular, Subject: Thunderstorms, and the Aeronautical Information Manual (AIM) recommend avoiding "by at least 20 miles any thunderstorm identified as severe or giving an intense radar echo."



WARNING: Lamp(s) inside this product may contain mercury (HG) and must be recycled or disposed of according to local, state, or federal laws. For more information, refer to our website at www.garmin.com/aboutGarmin/environment/disposal.jsp.



WARNING: Because of variation in the earth's magnetic field, operating the system within the following areas could result in loss of reliable attitude and heading indications. North of 72° North latitude at all longitudes. South of 70° South latitude at all longitudes. North of 65° North latitude between longitude 75° W and 120° W. (Northern Canada). North of 70° North latitude between longitude 70° W and 128° W. (Northern Canada). North of 70° North latitude between longitude 85° E and 114° E. (Northern Russia). South of 55° South latitude between longitude 120° E and 165° E. (Region south of Australia and New Zealand).



WARNING: Do not use GPS to navigate to any active waypoint identified as a 'NON WGS84 WPT' by a system message. 'NON WGS84 WPT' waypoints are derived from an unknown map reference datum that may be incompatible with the map reference datum used by GPS (known as WGS84) and may be positioned in error as displayed.



CAUTION: The PFD and MFD displays use a lens coated with a special anti-reflective coating that is very sensitive to skin oils, waxes, and abrasive cleaners. **CLEANERS CONTAINING AMMONIA WILL HARM THE ANTI-REFLECTIVE COATING.** It is very important to clean the lens using a clean, lint-free cloth and an eyeglass lens cleaner that is specified as safe for anti-reflective coatings.



CAUTION: The Garmin G1000 does not contain any user-serviceable parts. Repairs should only be made by an authorized Garmin service center. Unauthorized repairs or modifications could void both the warranty and the pilot's authority to operate this device under FAA/FCC regulations.



NOTE: When using Stormscope, there are several atmospheric phenomena in addition to nearby thunderstorms that can cause isolated discharge points in the strike display mode. However, clusters of two or more discharge points in the strike display mode do indicate thunderstorm activity if these points reappear after the screen has been cleared.



NOTE: All visual depictions contained within this document, including screen images of the G1000 panel and displays, are subject to change and may not reflect the most current G1000 system and aviation databases. Depictions of equipment may differ slightly from the actual equipment.



NOTE: This device complies with part 15 of the FCC Rules. Operation is subject to the following two conditions: (1) this device may not cause harmful interference, and (2) this device must accept any interference received, including interference that may cause undesired operation.



NOTE: The GDU 1040 and GDU 1044B PFD/MFD may require a warm-up time of up to 30 minutes when exposed to -40°C for an extended period. A warm-up time of up to 15 minutes may be required when exposed to -30°C for an extended period.



NOTE: This product, its packaging, and its components contain chemicals known to the State of California to cause cancer, birth defects, or reproductive harm. This notice is being provided in accordance with California's Proposition 65. If you have any questions or would like additional information, please refer to our web site at www.garmin.com/prop65.



NOTE: Interference from GPS repeaters operating inside nearby hangars can cause an intermittent loss of attitude and heading displays while the aircraft is on the ground. Moving the aircraft more than 100 yards away from the source of the interference should alleviate the condition.



NOTE: The purpose of this Cockpit Reference Guide is to provide the pilot a resource with which to find operating instructions on the major features of the G1000 system more easily. It is not intended to be a comprehensive operating guide. Complete operating procedures for the system are found in the G1000 Pilot's Guide for this aircraft.



NOTE: Use of polarized eyewear may cause the flight displays to appear dim or blank.

Blank Page

Part Number	Change Summary
190-00384-03 (Rev. A)	Added XM Radio and XM Weather Added ADF capability Added DME capability Added BRG1/BRG2 pointers Added dual audio panel operation Added C172 parameters Changed Airspeed Trend Vector Changed Altitude Trend Vector Added Checklist capability Added Flight ID capability
(Rev. B)	Updated system software numbers
190-00384-04 (Rev. A)	Reformatted manual to new format Added TAS capability
(Rev. B)	Added DONE Softkey, XM-INFORMATION Page, and XM-RADIO Page operation.
190-00384-05 (Rev. A)	Added explanation of EIS display behavior upon exceedances Added better explanation of Intercom System Isolation Added Stormscope operation upon loss of heading input Added TAWS-B Added CO Guardian Added new Fuel Totalizer Updated G1000 System Messages
190-00384-06 (Rev. A)	Added GDU 7.00 (WAAS, VNAV & Charts) software parameters. Added AFCS for the 182 and 206 Added database loading instructions Updated G1000 System Messages Combined previous system software numbers into 0563.00

RECORD OF REVISIONS

Part Number	Change Summary
190-00384-07 (Rev. A)	Added GDU 8.02 parameters, Airways, and ADS-B
190-00384-08 (Rev. A)	Added GDU 8.20 parameters, including gradient background on the PFD and GFC 700 for the C172.
190-00384-09 (Rev. A)	Added GDU 9.03 parameters. Removed gradient background. Added Additional Features section Changed tab structure
190-00384-10	Added GDU 9.15 Added new page navigation Added flight plan import/export Added new EIS displays Added CDI use in Dead Reckoning Mode Various clerical changes
190-00384-11	Added GDU 10.01 Added Auxiliary Video Added AOPA Airport Directory Added Flight Data Logging
190-00384-12	Added GDU 12.02 parameters Added FIS-B Weather Added GTS 800 Added GFDS Weather (GSR 56) Added Arrival Alerts

Revision	Date of Revision	Affected Pages	Description
A	October, 2011	All	Production Release

SECTION 1: SYSTEM OVERVIEW 1-1

1.1 PFD/MFD Controls 1-2

1.2 PFD Softkeys 1-5

1.3 MFD Softkeys 1-9

1.4 MFD Page Groups 1-10

1.5 Vertical Navigation 1-11

1.6 Arrival Alerts 1-13

1.7 Backlighting 1-13

1.8 Loading Updated Databases 1-14

 Loading Garmin Database Updates 1-14

 Loading the Jeppesen Navigation Database as the Active Navigation Database 1-15

 Loading the Jeppesen Navigation Database as the Standby Navigation Database 1-15

 Magnetic Field Variation Database Update 1-16

SECTION 2: FLIGHT INSTRUMENTS 2-1

2.1 Airspeed Indicator 2-3

 Speed Indication 2-3

 Speed Ranges 2-3

 Airspeed Trend Vector 2-3

 Vspeed References 2-3

2.2 Attitude Indicator 2-3

2.3 Altimeter 2-4

 Selected Altitude Bug 2-4

 Altitude Trend Vector 2-4

 Barometric Setting Box 2-4

 Altitude Alerting (GFC700 only) 2-4

 Metric Display 2-5

 Low Altitude Annunciation 2-5

2.4 Vertical Deviation/Glidepath/Glideslope Indicator 2-6

2.5 Marker Beacon Annunciations 2-7

2.6 Vertical Speed Indicator 2-7

2.7 Barometric Altitude Minimums 2-7

2.8 Horizontal Situation Indicator (HSI) 2-8

 Course Pointer 2-9

 Course Deviation Indicator (CDI) 2-9

 Bearing Pointers and Information Windows 2-11

 DME (optional) 2-11

 Navigation Source 2-11

2.9 Wind Data 2-12

2.10 Generic Timer 2-13

SECTION 3: ENGINE INDICATION SYSTEM (EIS) 3-1

3.1 Engine Display 3-1

3.2 Lean Display 3-4

 Normally-aspirated Aircraft 3-7

 Turbocharged Aircraft 3-7

3.3 System Display 3-7

SECTION 4: NAV/COM AND TRANSPONDER 4-1

4.1 Radio Status Indications 4-3

4.2 Volume 4-3

4.3 Automatic Squelch 4-3

4.4 Quickly Activating 121.500 MHz 4-3

4.5 Optional NAV Radios 4-3

 DME Radio (optional) 4-3

 ADF Radio (optional) 4-4

4.6 Frequency Auto-tuning 4-4

 Auto-tuning on the PFD 4-4

 Auto-tuning on the MFD 4-4

4.7 Transponder 4-4

 Mode Selection 4-4

 Reply Status 4-5

 Code Selection 4-5

SECTION 5: AUDIO PANEL 5-1

5.1 COM Radio Selection 5-2

5.2 Cabin Speaker 5-2

5.3 Passenger Address (PA) System (T)182T and (T)206H Only 5-2

5.4 Marker Beacon Receiver 5-2

 Marker Beacon Signal Sensitivity 5-2

5.5 Nav Radio Audio Selection 5-3

5.6 Intercom System (ICS) Isolation 5-3

5.7 Intercom Squelch Control 5-4

5.8 Digital Clearance Recorder and Player 5-4

SECTION 6: AUTOMATIC FLIGHT CONTROL 6-1

6.1 AFCS Controls 6-1

6.2 Flight Director Operation 6-2

 Activating the Flight Director 6-2

 Command Bars 6-2

 AFCS Status Box 6-3

6.3 Flight Director Modes 6-3

 Pitch Modes 6-3

 Roll Modes 6-17

TABLE OF CONTENTS

6.4 Autopilot Operation	6-22	Select the Nearest NDB Page	7-31
Flight Control	6-22	7.12 Nearest VOR	7-31
Engaging the Autopilot	6-22	Select the Nearest VOR Page	7-31
Control Wheel Steering	6-23	7.13 Nearest User Waypoint	7-32
Disengaging the Autopilot	6-23	Select the Nearest User Waypoint Page	7-32
6.5 Example Procedures	6-24	7.14 Nearest Frequencies	7-32
Departure	6-24	Select the Nearest Frequencies Page	7-32
Intercepting a VOR Radial	6-26	7.15 Nearest Airspaces	7-33
Flying a Flight Plan/GPS Course	6-27	Select the Nearest Airspaces Page	7-33
Descent	6-28		
Approach	6-31	SECTION 8: FLIGHT PLANNING	8-1
Go Around/Missed Approach	6-33	8.1 User Defined Waypoints	8-1
6.6 AFCS Annunciations and Alerts	6-34	Select the User WPT Information Page	8-1
AFCS Status Alerts	6-34	8.2 Viewing the Active Flight Plan	8-4
Overspeed Protection	6-35	8.3 Activate a Stored Flight Plan	8-4
		8.4 Activate a Flight Plan Leg	8-5
SECTION 7: NAVIGATION	7-1	8.5 Stop Navigating a Flight Plan	8-5
7.1 Navigation Map Page	7-1	8.6 Invert Active Flight Plan	8-5
Select the MAP Page Group	7-1	8.7 Create a Flight Plan	8-5
7.2 Direct-to Navigation	7-1	Create a Flight Plan Using the MFD	8-5
Direct-to Navigation from the MFD	7-1	Create a Flight Plan Using the PFD	8-6
Direct-to Navigation from the PFD	7-3	8.8 Import a Flight Plan from an SD Card	8-6
7.3 Navigating an Example Flight Plan	7-5	8.9 Enter an Airway in a Flight Plan	8-7
7.4 Airport Information	7-25	8.10 Load a Departure	8-9
Select the Airport Information Page	7-25	8.11 Load an Arrival	8-9
Display AOPA Airport Directory Information	7-26	8.12 Load an Approach	8-9
Select an Airport from the Database	7-26	8.13 Remove a Departure, Arrival, Approach,	
Select an Airport from the Active Flight Plan	7-26	or Airway from a Flight Plan	8-9
Select a Nearest Airport	7-26	8.14 Store a Flight Plan	8-9
Select a Recently Entered Airport Identifier	7-27	8.15 Edit a Stored Flight Plan	8-9
Select an Airport by Facility Name or City Location	7-27	8.16 Delete a Waypoint from the Flight Plan	8-9
7.5 Intersection Information	7-27	8.17 Invert and Activate a Stored Flight Plan	8-10
Select the Intersection Information Page	7-27	8.18 Copy a Flight Plan	8-10
7.6 NDB Information	7-28	8.19 Delete a Flight Plan	8-10
Select the NDB Information Page	7-28	8.20 Graphical Flight Plan Creation	8-10
7.7 VOR Information	7-28	8.21 Trip Planning	8-11
Select the VOR Information Page	7-28	8.22 Export a Flight Plan to an SD Card	8-12
7.8 User Waypoint Information Page	7-29		
7.9 Nearest Airports	7-29	SECTION 9: PROCEDURES	9-1
Nearest Airport Information on the MFD	7-29	9.1 Arrivals and Departures	9-1
Nearest Airports Information on the PFD	7-30	Load and Activate a Departure Procedure	9-1
7.10 Nearest Intersections	7-30	Load and Activate An Arrival Procedure	9-1
Select the Nearest Intersections Page	7-30	9.2 Approaches	9-2
7.11 Nearest NDB	7-31	Load and/or Activate an Approach Procedure	9-3

Activate An Approach in the Active Flight Plan 9-4
 Activate A Missed Approach in the Active Flight Plan.... 9-4

SECTION 10: HAZARD AVOIDANCE 10-1

10.1 Customizing the Hazard Displays on the Navigation Map 10-1
10.2 STORMSCOPE® (Optional) 10-1
 Displaying Stormscope Lightning Data on the Navigation Map Page 10-1
 Stormscope Page 10-2
10.3 XM Weather (Service Optional) 10-3
 Displaying METAR and TAF information on the Airport Information Page 10-3
 Displaying Weather on the Weather Data Link Page ... 10-4
 Map Panning Information – Weather Data Link Page . 10-5
 Displaying TFR Data: 10-5
 Enabling/disabling winds aloft data display in Profile View: 10-6
 Weather Products & Symbols 10-6
 Weather Product Age 10-7
10.4 FIS-B Weather (Optional) 10-7
 Accessing FIS-B Weather Products 10-7
 Setting Up and Customizing the FIS-B Weather Data Link Page 10-8
 Restoring Default FIS-B Weather Data Link Page Settings 10-9
 Switching Between FIS-B, GFDS and XM WX Sources . 10-9
 Viewing Legends for Displayed FIS-B Weather Products 10-9
 Setting Up and Customizing Weather Data for the Navigation Map Page 10-9
 FIS-B Weather Products 10-10
 Displaying Precipitation Weather Information 10-11
10.5 Worldwide Weather (Optional) 10-12
 Registering with Garmin Flight Data Services 10-12
 Switching Between GFDS, FIS-B and XM WX Sources 10-13
 Accessing GFDS Worldwide Weather Products 10-13
 Setting Up and Customizing the GFDS Weather Data Link Page 10-14
 Restoring Default GFDS Weather Data Link Page Settings 10-14
 Viewing Legends for Displayed GFDS Weather Products 10-15

Setting Up and Customizing Weather Data for the Navigation Map Page 10-15
 GFDS Weather Data Requests 10-16
 Worldwide Weather Products 10-19
10.6 Traffic Systems 10-23
 Traffic Information Service (TIS) 10-23
 Traffic Advisory Systems (Optional) 10-24
 ADS-B Traffic GDL 90 (Optional) 10-27
10.7 Terrain and Obstacle Proximity 10-28
 Displaying Terrain and Obstacles on the Terrain Proximity Page 10-28
 Displaying Terrain and Obstacles on the Navigation Map 10-28
10.8 TERRAIN-SVS Display (Optional) 10-29
 Displaying Terrain on the TERRAIN-SVS Page 10-29
 Enable/Disable Aviation Data 10-30
 TERRAIN-SVS Alerts 10-30
 Terrain Inhibit 10-33
 Forward Looking Terrain Avoidance (FLTA) 10-33
 Displaying Terrain and Obstacles on the Navigation Map 10-34
10.9 Terrain Awareness & Warning System (TAWS) Display (Optional) 10-34
 Displaying Terrain on the TAWS-B Page 10-34
 Enable/Disable Aviation Data 10-35
 TAWS Inhibit 10-35
 Manual System Test 10-35
 Forward Looking Terrain Avoidance (FLTA) 10-36
 Premature Descent Alert (PDA) 10-36
 Excessive Descent Rate Alert (EDR) 10-36
 Negative Climb Rate After Takeoff Alert (NCR) 10-36
 “Five-Hundred” Aural Alert 10-37
 Displaying Terrain and Obstacles on the Navigation Map 10-37
 Pop-up Alerts 10-37
 TAWS Alerts Summary 10-38
 Alert Annunciations 10-39

SECTION 11: ADDITIONAL FEATURES 11-1

11.1 Synthetic Vision System (SVS) (Optional) 11-1
 SVS Operation 11-1
 SVS Features 11-2
 Field of View 11-9
11.2 SafeTaxi 11-10

TABLE OF CONTENTS

11.3 ChartView (Optional)	11-11
Chart Options	11-12
Day/Night View	11-13
11.4 FliteCharts	11-14
Chart Options	11-15
Day/Night View	11-15
11.5 AOPA Airport Directory	11-15
11.6 XM Radio Entertainment (Service Optional)	11-16
Using XM Radio	11-16
Automatic Audio Muting	11-18
11.7 Scheduler	11-18
11.8 Electronic Checklists	11-20
11.9 Flight Data Logging	11-23
11.10 Auxiliary Video (Optional)	11-24
Video Setup	11-25
Display Selection	11-25
Input Selection	11-25
Zoom/Range	11-26

SECTION 12: ABNORMAL OPERATION	12-1
12.1 Reversionary Mode	12-1
12.2 Abnormal COM Operation	12-2
12.3 Unusual Attitudes	12-2
12.4 Stormscope Operation with loss of Heading Input	12-2
12.5 Hazard Displays with Loss of GPS Position	12-2
12.6 Dead Reckoning	12-3

SECTION 13: ANNUNCIATIONS & ALERTS	13-1
13.1 Alert Level Definitions	13-2
13.2 NAV III Aircraft Alerts	13-3
WARNING Alerts (172R, 172S, 182T, T182T, 206H, and T206H)	13-3
CAUTION Alerts (172R, 172S, 182T, T182T, 206H, and T206H)	13-3
CAUTION Alerts (T182, T206, and 206 with Prop De-Ice Only).....	13-3
Safe Operating Annunciation (T182, T206, and 206 with Prop De-Ice Only).....	13-3
13.3 CO Guardian Messages	13-3
13.4 AFCS Alerts	13-4
System Status Annunciation.....	13-4
13.5 Terrain-SVS Alerts	13-5
13.6 TAWS Alerts	13-6

13.7 Other G1000 Aural Alerts	13-8
13.8 G1000 System Annunciations	13-9
13.9 G1000 System Message Advisories	13-12
MFD & PFD Message Advisories.....	13-12
Database Message Advisories.....	13-13
GMA 1347 Message Advisories	13-16
GIA 63 Message Advisories	13-16
GIA 63W Message Advisories	13-19
GEA 71 Message Advisories	13-22
GSR 56 Message Advisories.....	13-22
GDC 74A Message Advisories.....	13-22
GTX 33 Message Advisories.....	13-23
GRS 77 Message Advisories.....	13-23
GMU 44 Message Advisories.....	13-24
GDL 69/69A Message Advisories	13-24
Miscellaneous Message Advisories.....	13-24
13.10 Flight Plan Import/Export Messages	13-27

INDEX	Index-1
--------------------	---------

SECTION 1: SYSTEM OVERVIEW

The purpose of this Cockpit Reference Guide is to provide the pilot a resource with which to find operating instructions on the major features of the G1000 system more easily. **It is not intended to be a comprehensive operating guide.** Complete operating procedures for the complete system are found in the Garmin G1000 Pilot's Guide for the Cessna Nav III (190-00498-07).

This guide gives the pilot abbreviated operating instructions for the Primary Flight Display (PFD), Multi Function Display (MFD), and the GMA 1347 Audio Panel System.



NOTE: *The pilot should read and thoroughly understand the Cessna Pilot's Operating Handbook (POH) for limitations, procedures and operational information not contained in this Cockpit Reference Guide. The Cessna POH always takes precedence over the information found in this guide.*

SECTION 1 SYSTEM OVERVIEW

1.1 PFD/MFD CONTROLS

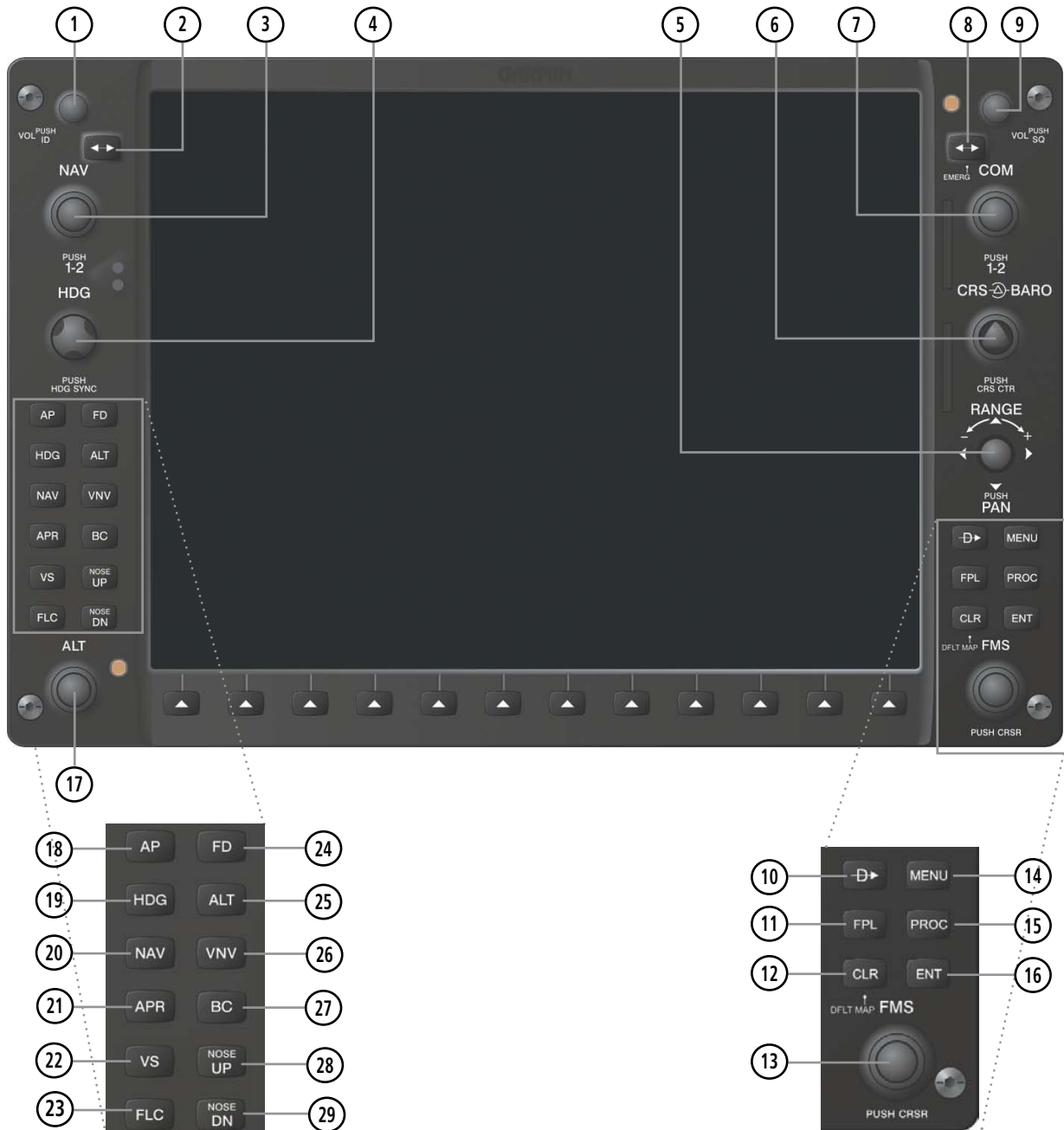

GFC 700 AFCS Only

Figure 1-1 PFD/MFD Controls

PFD and MFD controls function the same.

- ① **NAV VOL/ID Knob** – Controls the NAV audio level. Press to turn the Morse code identifier ON and OFF. Volume level is shown in the field as a percentage.
- ② **NAV Frequency Transfer Key** – Transfers the standby and active NAV frequencies.
- ③ **Dual NAV Knob** – Tunes the MHz (large knob) and kHz (small knob) standby frequencies for the NAV receiver. Press to switch the tuning box (light blue box) between the NAV1 and NAV2 fields.
- ④ **Heading Knob** – Turn to manually select a heading on the HSI. When pressed, it synchronizes the heading bug with the compass lubber line. Selected Heading provides the heading reference to the Flight Director while operating in Heading Select Mode.
- ⑤ **Joystick** – Changes the map range (distance top to bottom of map display) when rotated. Activates the map pointer when pressed.
- ⑥ **CRS/BARO Knob** – The large knob sets the altimeter barometric pressure and the small knob adjusts the course. The course is only adjustable when the HSI is in VOR1, VOR2, or OBS/SUSP Mode. Pressing this knob centers the CDI on the currently selected VOR. Selected Course provides course reference to the Flight Director when operating in Navigation and Approach Modes.
- ⑦ **Dual COM Knob** – Tunes the MHz (large knob) and kHz (small knob) standby frequencies for the COM transceiver. Pressing this knob switches the tuning box (light blue box) between the COM1 and COM2 fields.
- ⑧ **COM Frequency Transfer Key** – Transfers the standby and active COM frequencies. Pressing and holding this key for two seconds automatically tunes the emergency frequency (121.5 MHz) in the active frequency field.
- ⑨ **COM VOL/SQ Knob** – Controls COM audio level. Pressing this knob turns the COM automatic squelch ON and OFF. Audio volume level is shown in the field as a percentage.
- ⑩ **Direct-to Key** – Allows the user to enter a destination waypoint and establish a direct course to the selected destination (specified by the identifier, chosen from the active route, or taken from the map pointer position).
- ⑪ **FPL Key** – Displays the active Flight Plan Page for creating and editing the active flight plan, or for accessing stored flight plans.
- ⑫ **CLR Key (DFLT MAP)** – Erases information, cancels an entry, or removes page menus. To display the Navigation Map Page immediately, press and hold **CLR** (MFD only).
- ⑬ **Dual FMS Knob** – Used to select the page to be viewed (only on the MFD). The large knob selects a page group (MAP, WPT, AUX, FPL, NRST), while the small knob selects a specific page within the page group. Pressing the small knob turns the selection cursor ON and OFF. When the cursor is ON, data may be entered in the different fields using the small and large knobs. The large knob is used to move the cursor on the page, while the small knob is used to select individual characters for the highlighted cursor location. When the G1000 displays a list that is too long for the display screen, a scroll bar appears along the right

side of the display, indicating the availability of additional items within the selected category. Press the small **FMS** Knob to activate the cursor and turn the large **FMS** Knob to scroll through the list.

- ⑭ **MENU Key** – Displays a context-sensitive list of options. This list allows the user to access additional features, or to make setting changes that relate to certain pages.
- ⑮ **PROC Key** – Selects approaches, departures and arrivals from the flight plan. If a flight plan is used, available procedures for the departure and/or arrival airport are automatically suggested. If a flight plan is not used, the desired airport and the desired procedure may be selected. This key selects IFR departure procedures (DPs), arrival procedures (STARs) and approaches (IAPs) from the database and loads them into the active flight plan.
- ⑯ **ENT Key** – Accepts a menu selection or data entry. This key is used to approve an operation or complete data entry. It is also used to confirm selections and information entries.
- ⑰ **Dual ALT Knob** – Sets the selected altitude in the box located above the Altimeter. The large knob selects the thousands (500m for metric), while the small knob selects the hundreds (50m for metric). Altitude Select is used by the Automatic Flight Control System in certain modes, in addition to the standard G1000 Altitude Alerter function.

The following are only available with the GFC 700 AFCS.

- ⑱ **AP Key** – Engages/disengages the Autopilot and Flight Director. Pressing the **AP** Key activates the Flight Director and engages the Autopilot in the default pitch axis and roll axis modes. Pressing the **AP** Key again disengages the autopilot and deactivates the Flight Director.
- ⑲ **HDG Key** – Selects/deselects the Heading Select Mode.
- ⑳ **NAV Key** – Selects/deselects the Navigation Mode.
- ㉑ **APR Key** – Selects/deselects the Approach Mode.
- ㉒ **VS Key** – Selects/deselects the Vertical Speed Mode.
- ㉓ **FLC Key** – Selects/deselects the Flight Level Change Mode.
- ㉔ **FD Key** – Activates/deactivates the Flight Director only. Pressing the **FD** Key turns on the Flight Director in the default pitch axis and roll axis modes. Pressing the **FD** Key again deactivates the Flight Director and removes the command bars, unless the Autopilot is engaged. If the Autopilot is engaged, the **FD** Key is disabled.
- ㉕ **ALT Key** – Selects/deselects the Altitude Hold Mode.
- ㉖ **VNV Key** – Selects/deselects Vertical Navigation Mode.
- ㉗ **BC Key** – Selects/deselects Back Course Mode.
- ㉘ ㉙ **NOSE UP/NOSE DN Keys** – Controls the active pitch reference for the Pitch Hold, Vertical Speed, and Flight Level Change Modes.

1.2 PFD SOFTKEYS

TERRAIN
Softkey ON

TERRAIN
Softkey OFF

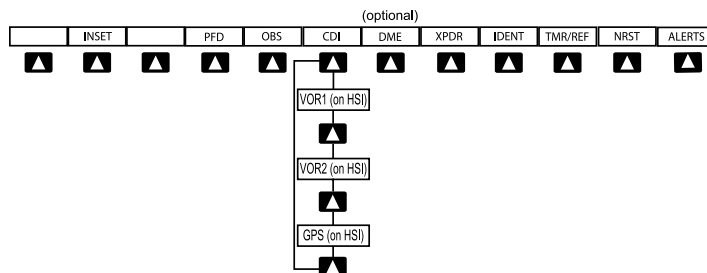

Figure 1-2 PFD Top Level Softkeys

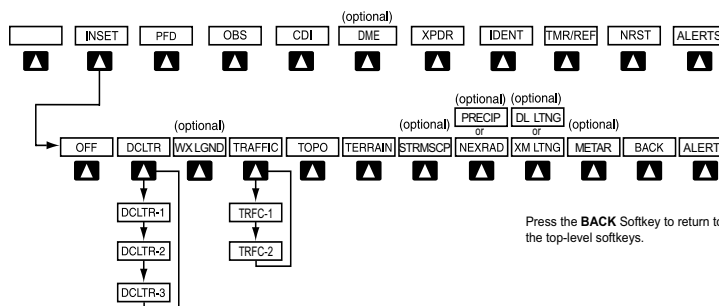

Figure 1-2 INSET Softkeys

INSET – Press to display the Inset Map in the lower left corner of the PFD.

OFF – Press to remove the Inset Map.

DCLTR (3) – Press momentarily to select the desired amount of map detail. The declutter level appears adjacent to the **DCLTR** Softkey.

- No declutter: All map features are visible.
- Declutter – 1: Declutters land data.
- Declutter – 2: Declutters land and SUA data.
- Declutter – 3: Declutters large NAV data remaining (removes everything except the active flight plan).

WX LGND – Displays icon and age on the Inset Map for the selected weather products (optional)

TRAFFIC – Cycles through traffic display options:

- TRFC-1: Traffic displayed on inset map
- TRFC-2: Traffic Map Page is displayed in the inset map window

TOPO – Press to display topographical data (i.e., coastlines, terrain, rivers, lakes, etc.) and elevation scale on the Inset Map.

TERRAIN – Press to display terrain information on the Inset Map.

STRMSCP (optional) – Press to display the Stormscope lightning data on the Inset Map (within a 200 nm radius of the aircraft).

NEXRAD/PRECIP (optional) – Press to display NEXRAD weather and coverage information on the Inset Map or FIS-B/GFDS precipitation on the Inset Map

XM LTNG/DL LTNG (optional) – Press to display XM/DL lightning information on the Inset Map.

METAR (optional) – Press to display METAR flags for the airport symbols on the Inset Map

BACK – Press to return to the previous level softkey configuration.

disabling Synthetic Vision features.

PATHWAY – Displays rectangular boxes representing the horizontal and vertical flight path of the active flight plan.

SYN TERR – Enables synthetic terrain depiction.

HRZN HDG – Displays compass heading along the Zero-Pitch line.

APTSIGNS – Displays position markers for airports within approximately 15 nm of the current aircraft position. Airport identifiers are displayed when the airport is within approximately 9 nm.

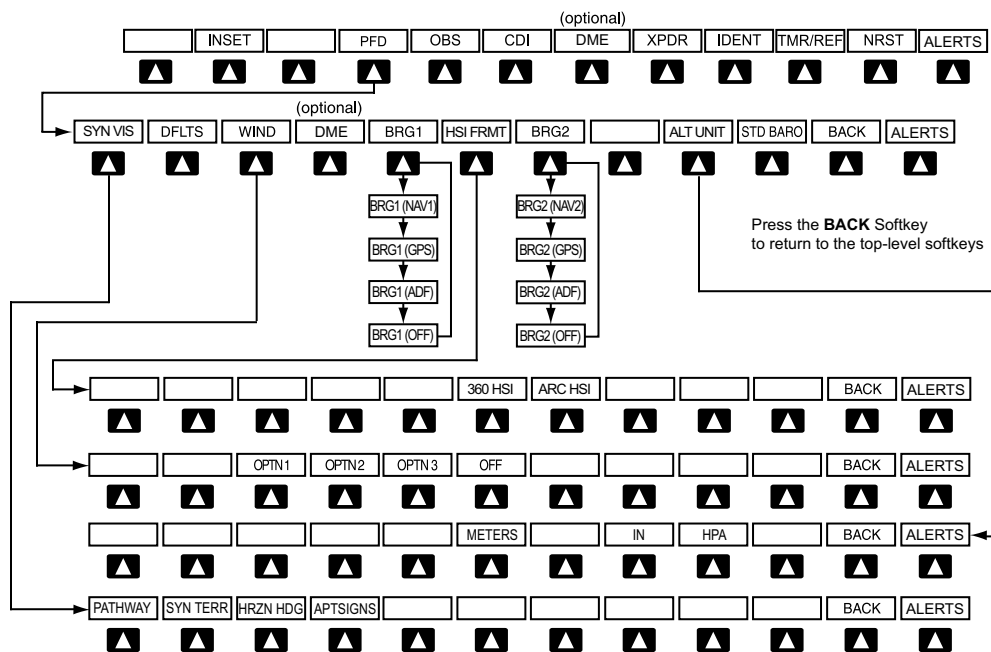

Figure 1-3 PFD Configuration Softkeys

PFD – Press to display the additional softkeys for additional configuration of the PFD.

DFLTS – Press to reset default settings on the PFD.

SYN VIS – Displays the softkeys for enabling or

WIND – Displays softkeys to select wind data parameters.

OPTN 1 – Wind direction arrows with headwind and crosswind components.

OPTN 2 – Wind direction arrow and speed.

OPTN 3 – Wind direction arrow with direction and speed.

OFF – Information not displayed.

DME (optional) – Press to display the DME Information Window.

BRG1 (bearing) – Press to cycle through the following Nav sources, making the pointer the indicator for the corresponding source and displaying the appropriate information.

NAV1 – Displays NAV1 waypoint frequency or identifier and DME information in the BRG1 Information Window.

GPS – Displays GPS waypoint identifier and GPS distance information in the BRG1 Information Window.

ADF – Displays ADF in the BRG1 Information Window when an optional ADF is installed.

OFF – Removes the BRG1 Information Window.

HSI FRMT – Press to display the HSI formatting softkeys.

360 HSI – Press to display the HSI in a 360 degree format.

ARC HSI – Press to display the HSI in an arc format.

BRG2 (bearing) – Press to cycle through the following Nav sources, making the pointer the indicator for the corresponding source and displaying the appropriate information.

NAV2 – Displays NAV2 waypoint frequency or identifier and DME information in the BRG2 Information Window.

GPS – Displays GPS waypoint identifier and GPS distance information in the BRG2 Information Window.

ADF – Displays ADF in the BRG2 Information Window when an optional ADF is installed.

OFF – Removes the BRG2 Information Window.

ALT UNIT – Displays softkeys for setting the altimeter and BARO settings to metric units:

METERS – When enabled, displays altimeter in meters.

IN – Press to display the BARO setting as inches of mercury.

HPA – Press to display the BARO setting as hectopascals.

STD BARO – Press to set the barometric pressure to standard pressure.

BACK – Press to return to the previous level softkeys.

ALERTS – Press to display the Alerts Window.

OBS – Press to select OBS Mode on the CDI when navigating by GPS (only available with active leg).

CDI – Press to change navigation mode on the CDI between GPS, VOR1, and VOR2.

DME (optional) – Press to display the DME Tuning Window.

XPDR – Press to display the transponder mode selection softkeys.

STBY – Press to select Standby Mode.

ON – Press to select Mode A.

ALT – Press to select Altitude Reporting Mode.

GND – Press to select Ground Mode.

VFR – Press to automatically squawk 1200 (only in the U.S.A., refer to ICAO standards for VFR codes in other countries).

CODE – Press to display transponder code selection softkeys 0-7.

0 through 7 – Press numbers to enter code or use the small FMS knob to enter the first two digits then turn the large FMS knob to move the cursor. Again using the small FMS knob enter the second two digits.

IDENT – Press to provide special aircraft position identification to Air Traffic Control (ATC).

BKSP – Press to remove numbers entered one at a time.

BACK – Press to return to the previous level softkeys

IDENT – Press to provide special aircraft position identification to Air Traffic Control (ATC).

BACK – Press to return to the previous level softkeys.

ALERTS – Press to display the Alerts Window.

IDENT – Press to provide special aircraft position identification to Air Traffic Control (ATC).

TMR/REF – Press to display the Timer/References Window.

NRST – Press to display the Nearest Airports Window.

ALERTS/ADVISORY – Press to display the Alerts/Advisory Window.

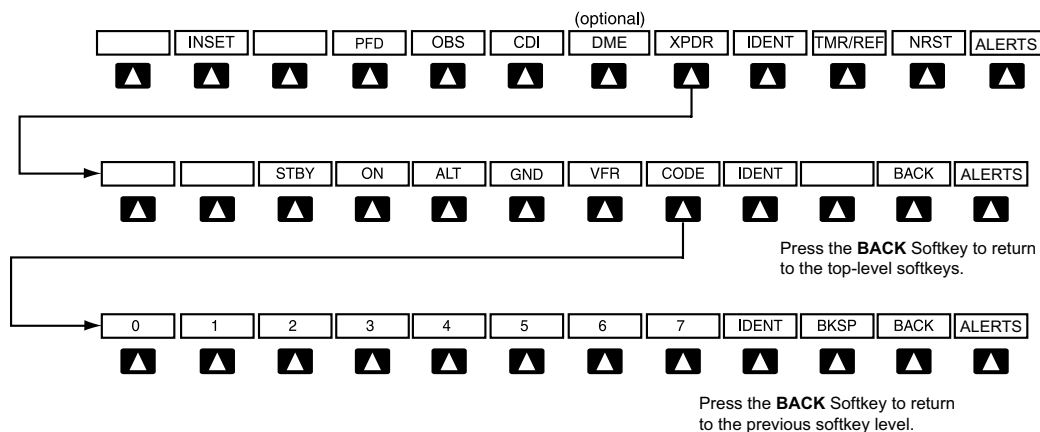

Figure 1-4 XPDR (Transponder) Softkeys

1.3 MFD SOFTKEYS

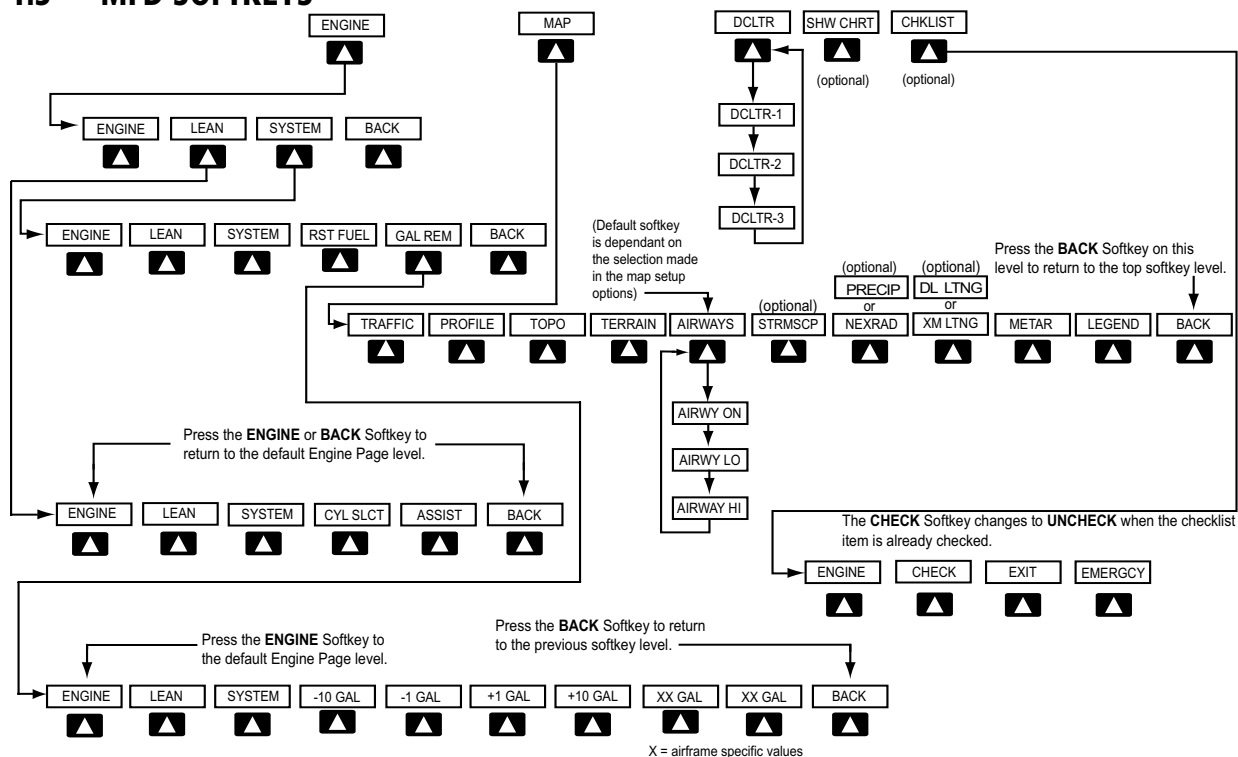

Figure 1-5 MFD Softkeys

ENGINE – Pressing this softkey makes available the **LEAN** and **SYSTEM** Softkeys which in turn access the Lean Page and the System Page, respectively.

MAP – Pressing this softkey enables the following softkeys:

TRAFFIC – Pressing this softkey displays/removes Traffic on the Navigation Map.

PROFILE – Pressing this softkey displays/removes Profile view on the Navigation Map.

TOPO – Pressing this softkey displays or removes topographic information on the Navigation Map.

TERRAIN – Pressing this softkey displays/removes terrain and obstacle data on the Navigation Map.

AIRWAYS – Pressing this softkey displays/removes airways information. The default is dependent on map setup option selected. Pressing cycles through all airways displayed (**AIRWY ON**), low altitude airways only (**AIRWY LO**), and high altitude airways only (**AIRWY HI**).

STRMSCP (optional) – Pressing this softkey displays/removes Stormscope lightning data on the Navigation Map.

NEXRAD/PRECIP (optional) – Pressing this softkey displays/removes precipitation data on the Navigation Map.

XM LTNG/DL LTNG (optional) – Pressing this softkey displays/removes XM/DL lightning data on the Navigation Map.

METAR – Pressing this softkey displays METAR flags on airport symbols on the Navigation flag.

LEGEND – Pressing this softkey displays the Legend

BACK – Pressing this softkey displays the ENGINE and MAP top level softkeys.

DCLTR (declutter) – Pressing this softkey removes map information in three levels.

SHW CHRT (Show Chart)(optional) – Pressing this softkey displays optional FliteCharts or ChartView charts.

CHKLIST (checklist)(optional) – Pressing the **CHKLIST** Softkey displays the Checklist Page.

ENGINE – Displays engine softkeys.

CHECK – Pressing this softkey checks off a checklist item. If an item is already checked, an **UNCHECK** Softkey is displayed.

EXIT – Press to exit the checklist.

EMERGCY – Pressing this softkey displays the emergency checklist.

1.4 MFD PAGE GROUPS

- 1) Turn the large **FMS** Knob until the desired page group is selected.
- 2) Turn the small **FMS** Knob to select pages within the group. See Figure 1-7.

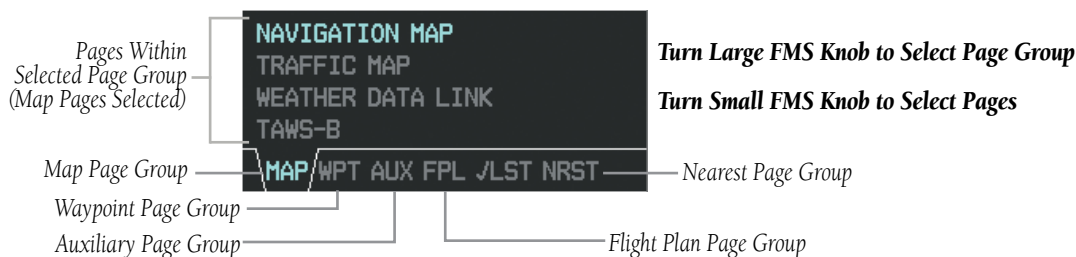

Figure 1-6 Page Groups

1.5 VERTICAL NAVIGATION

One of two altitude sources is used by the G1000 when giving vertical navigation guidance. SBAS GPS altitude is used when giving guidance for an SBAS approach after the Final Approach Fix. Baro corrected altitude is used when vertical guidance is given in all other situations and in non-SBAS systems.

The G1000 system can use altitude constraints associated with lateral waypoints to give guidance for vertical navigation. These altitudes are, depending on the specific instance, entered by the pilot or retrieved from the published altitudes in the navigation database.

The navigation database only contains altitudes for procedures that call for “Cross at” altitudes. If the procedure states “Expect to cross at,” then the altitude is not in the database. In this case the altitude may be entered manually.



NOTE: *All arrival procedure altitudes contained in the navigation database are for turbojet aircraft only. Alter or enter altitudes as desired to comply with the ATC clearance.*

When activating or loading an arrival or approach procedure into an active flight plan, the VNV ‘ALT’ fields are populated with any altitudes that can be retrieved from the navigation database.

Since altitudes loaded with an arrival procedure are published only for turbojet aircraft, the altitudes are displayed as white text indicating that the altitudes are displayed for reference only. An arrival waypoint altitude may be used (or “designated”) as is, or changed to a different altitude. An altitude is designated by pressing the **FMS** Knob and turning the large **FMS** Knob to place the cursor on the desired altitude and pressing the **ENT** Key or entering a different value and pressing the **ENT** Key. The

altitude is now displayed as light blue text, indicating that the altitude is now designated to give vertical speed and deviation guidance.

Approach waypoint altitude constraints are automatically designated when the approach is loaded. These altitudes are also displayed as light blue text. Waypoint altitude constraints are designated up to, but not including the FAF. The FAF is always a “reference only” altitude and cannot be designated, unless the selected approach does not provide vertical guidance. In this case, the FAF altitude can be designated manually.

Altitudes that have been designated for use in vertical guidance may also be made “non-designated” by placing the cursor over the desired altitude and pressing the **CLR** Key. Other displayed altitudes may change due to re-calculations or rendered invalid as a result of manually changing an altitude to a non-designated altitude.

To help interpret the meanings of how the altitudes are presented, keep the following points in mind:

- When the altitude is displayed in light blue, the system is using that altitude (designated) to determine vertical speed and deviation guidance.
- When the altitude is displayed in white, it is not being used by the system (non-designated) to determine the vertical speed and deviation guidance.
- An altitude displayed as small text is an altitude that is published in the navigation database.
- Altitudes displayed as a light blue subdued text cannot be used in the current vertical navigation calculations.

Refer to Figure 1-8 and Table 1-1 for more detail regarding the significance of text size and color.

SECTION 1 SYSTEM OVERVIEW

	White Text	Light Blue Text	Light Blue Subdued Text
Large Text	Altitude calculated by the system estimating the altitude of the aircraft as it passes over the navigation point. This altitude is provided as a reference and is not designated to be used in determining vertical speed and deviation guidance.	Altitude has been entered by the pilot. Altitude is designated for use in giving vertical speed and deviation guidance. Altitude does not match the published altitude in navigation database or no published altitude exists.	The system cannot use this altitude in determining vertical speed and deviation guidance.
Small Text	Altitude is not designated to be used in determining vertical speed and deviation guidance. Altitude has been retrieved from the navigation database and is provided as a reference.	Altitude is designated for use in giving vertical speed and deviation guidance. Altitude has been retrieved from the navigation database or has been entered by the pilot and matches a published altitude in the navigation database.	The system cannot use this altitude in determining vertical speed and deviation guidance.

Table 1-1 VNV Altitude Text Size and Color

ACTIVE FLIGHT PLAN			
KIXD / KDFW			
	DTK	DIS	ALT
KARLA	221°	11.7NM	13000FT
COVIE	221°	9.0NM	12400FT
LEMYN	220°	8.0NM	9900FT
Approach - KDFW-RNAV 17L GPS LPV			
RIVET <i>iaf</i>	259°	18.8NM	4000FT
DRAAK	176°	3.3NM	2000FT
INWOD	176°	3.2NM	3000FT
MENOL <i>faf</i>	176°	3.9NM	2300FT
RW17L <i>map</i>	176°	5.3NM	990FT
POLKE	174°	0.8NM	990FT

Figure 1-7 VNAV Altitudes

Some altitudes retrieved from the database have associated restrictions indicating to stay 'At', 'At or Above', or 'At or Below' a specific altitude. These restrictions are indicated using a 'bar' above and/or below the appropriate altitude as shown in Figure 1-9.



Figure 1-9 Altitude Restrictions

See Section 7 - Navigation, for a sample flight plan which further illustrates vertical navigation in more detail.

1.6 ARRIVAL ALERTS

The Arrival Alert Box on the System Setup Page allows the Alerts Window arrival alert to be turned ON/OFF. The alert trigger distance (up to 99.9 units) may also be set for alerts in the Alerts Window and the PFD Navigation Status Box. An arrival alert can be set to notify the pilot with a message upon reaching a user-specified distance from the final destination (the direct-to waypoint or the last waypoint in a flight plan). When an Arrival Alert is set to ON, and the set distance is reached, an “Arrival at waypoint” message is displayed in the PFD Navigation Status Box, and a “WPT ARRIVAL - Arriving at waypoint - [xxxx]” is displayed in the Alerts Window. When Arrival Alert is set to OFF, only the PFD Navigation Status Box message “Arriving at waypoint” is displayed, and it is displayed when the time to the final destination is approximately ten seconds.

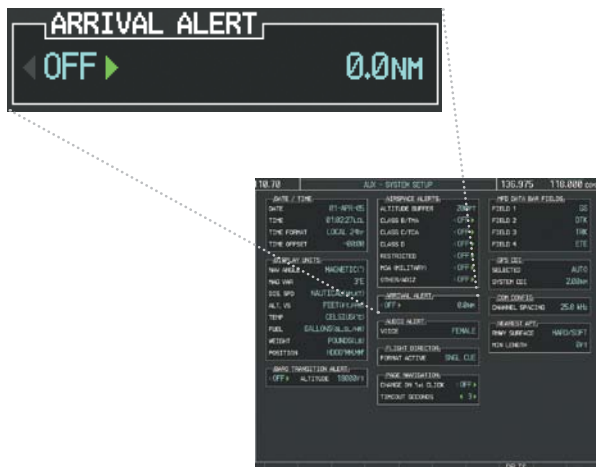

Figure 1-8 Arrival Alert Settings
(System Setup Page)

1.7 BACKLIGHTING

Manually adjust the backlight for the PFD and MFD:

- 1) Press the **MENU** Key on the PFD to display the PFD Setup Menu window.
- 2) Press the small **FMS** Knob to activate the cursor. 'PFD DSPL > AUTO' is now highlighted.
- 3) Turn the small **FMS** Knob to display the selection window.
- 4) Turn the small **FMS** Knob to select 'MANUAL', then press the **ENT** Key.
- 5) With the intensity value now highlighted, turn the small **FMS** Knob to select the desired backlighting.
- 6) Turn the large **FMS** Knob to highlight 'MFD DSPL > AUTO' and repeat steps 3 through 5.

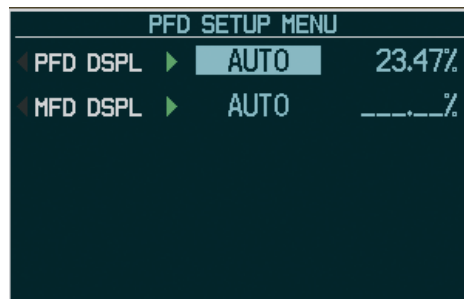

Figure 1-9 PFD Setup Menu Window

1.8 LOADING UPDATED DATABASES



CAUTION: *Never disconnect power to the system when loading a database. Power interruption during the database loading process could result in maintenance being required to reboot the system.*



NOTE: *When loading database updates, the 'DB Mismatch' message will be displayed until database synchronization is complete, followed by turning system power off, then on. Synchronization can be monitored on the AUX-SYSTEM STATUS Page.*

In some cases it may be necessary to obtain an unlock code from Garmin in order to make the database product functional. It may also be necessary to have the system configured by a Garmin authorized service facility in order to use some database features.

If an error occurs during synchronization, an error message will be displayed, followed by the affected display in the Sync Status section of the Database Window. If synchronization completes on one display, but an error occurs on another, the error message will be displayed with the affected displays listed after it. When an error message is displayed, the problem must be corrected before synchronization can be completed. A power cycle is required to restart synchronization when 'Card Full' or 'Err' is shown.

Error Message	Description
Canceled	Database synchronization has been canceled by removing the bottom SD card in display being updated
Card Full	SD card does not contain sufficient memory

Error Message	Description
Err	Displayed for all other errors that may cause the synchronization process to be halted
Timeout	System timed-out prior to the database transfer completing

Table 1-2 Database Error Messages

Loading Garmin Database Updates

- 1) With system power OFF, remove the MFD database card from the bottom card slot of the MFD.
- 2) Update the Garmin databases on the MFD card.
- 3) Insert the MFD database card into the bottom card slot of the MFD.
- 4) Apply power to the system, check that the databases are initialized and displayed on the power-up screen. When updating the terrain and FliteCharts databases, a 'Verifying' message may be seen. If this message is present, wait for the system to finish loading before proceeding to step 5.
- 5) Acknowledge the Power-up Page agreement by pressing the **ENT** Key or the right most softkey.
- 6) Turn the large **FMS** Knob to select the AUX Page group on the MFD.
- 7) Turn the small **FMS** Knob to select the System Status Page.
- 8) Monitor the Sync Status in the Database Window. Wait for all databases to complete synching, indicated by 'Complete' being displayed.
- 9) Remove and reapply power to the system.
- 10) Turn the large **FMS** Knob to select the AUX Page group on the MFD.
- 11) Turn the small **FMS** Knob to select the System Status Page.

- 12) Press the Display Database Selection Softkey to show database information for each display (**MFD1 DB, PFD1 DB**). Verify the correct database cycle information is shown for each database for each display.

Loading the Jeppesen Navigation Database as the Active Navigation Database



NOTE: Loading the Jeppesen navigation database as the active database prior to its effective date will result in the expiration date on the power-up screen and the effective date on the AUX-System Status Page being displayed in yellow.



NOTE: After the navigation database is loaded or copied, the top SD card may be removed.

- 1) With the system OFF, insert the SD card containing the new navigation database version into the top card slot of the display (PFD or MFD) to be updated (label of SD card facing left).
- 2) Turn the system ON. A prompt is displayed in the upper left corner of the display:
- 3) Press the **NO** Softkey to proceed to loading the active database.
- 4) A prompt similar to the following is displayed. Press the **YES** Softkey to update the active navigation database.
- 5) After the update completes, the display starts in normal mode.
- 6) Turn the system OFF and remove the SD card from the top card slot.
- 7) Repeat steps 1 through 6 for the other displays (PFD or MFD).
- 8) Apply power to the system and press the **ENT** Key to acknowledge the startup screen.

- 9) Turn the large **FMS** Knob to select the AUX Page group on the MFD.
- 10) Turn the small **FMS** Knob to select the System Status Page.
- 11) Press the Display Database Selection Softkey to show active navigation database information for each display (**MFD1 DB, PFD1 DB**). Verify the correct active navigation database cycle information is shown for each display.

Loading the Jeppesen Navigation Database as the Standby Navigation Database



NOTE: After the navigation database is loaded or copied, the top SD card may be removed.

- 1) With the system OFF, insert the SD card containing the new navigation database version into the top card slot of the MFD.
- 2) Verify that an SD card is inserted in the bottom slot of each PFD and the MFD.
- 3) Turn the system ON. A prompt is displayed.
- 4) Press the **YES** Softkey. The navigation database is copied to the SD card in the bottom card slot of the MFD.
- 5) After the navigation database files are copied to the bottom SD card, press any key to continue, as instructed.
- 6) Again, press any key to continue as instructed on the display.
- 7) Press the **NO** Softkey. The display now starts in normal mode. Since the database effective date is not yet valid, it should not be loaded as the active database. The display now starts in normal mode. Do not remove power while the display is starting.
- 8) Press the **ENT** Key to acknowledge the startup screen.

- 9) Turn the large **FMS** Knob to select the AUX Page group on the MFD.
- 10) Turn the small **FMS** Knob to select the System Status Page.
- 11) The new database is copied to the SD card in the bottom card slot of each PFD. Progress can be monitored in the SYNC STATUS field. When copying is finished, 'Complete' is displayed.



NOTE: During the synchronization process, version differences between standby navigation databases will exist. This will result in the system displaying a 'DB Mismatch' alert for the standby navigation databases. This alert will remain until the next power cycle.

- 12) Turn system power OFF.
- 13) Remove the SD card from the top card slot of the MFD.
- 14) Turn system power ON.
- 15) Press the **ENT** Key to acknowledge the startup screen.
- 16) Turn the large **FMS** Knob to select the AUX Page group on the MFD.
- 17) Turn the small **FMS** Knob to select the System Status Page.
- 18) Press the Display Database Selection Softkey to show standby navigation database information for each display (**MFD1 DB**, **PFD1 DB**). Verify the correct standby navigation database cycle information is shown for each display.

Magnetic Field Variation Database Update

At startup, the system compares this version of the MV DB with that presently being used by the AHRS (GRS). If the system determines the MV DB needs to be updated, a prompt is displayed on the Navigation Map Page, as shown in Figure 1-10.

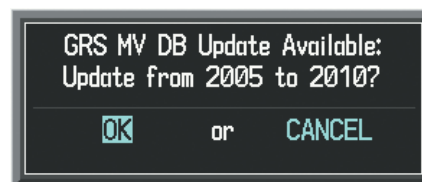

Figure 1-10 GRS Magnetic Field Variation Database Update Prompt

Loading the magnetic field variation database update:

With 'OK' highlighted, as shown in the previous figure, press the ENT Key on the MFD. A progress monitor is displayed as shown in Figure 1-11.

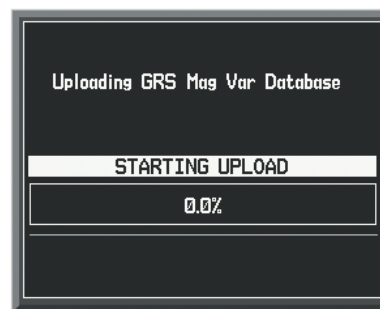
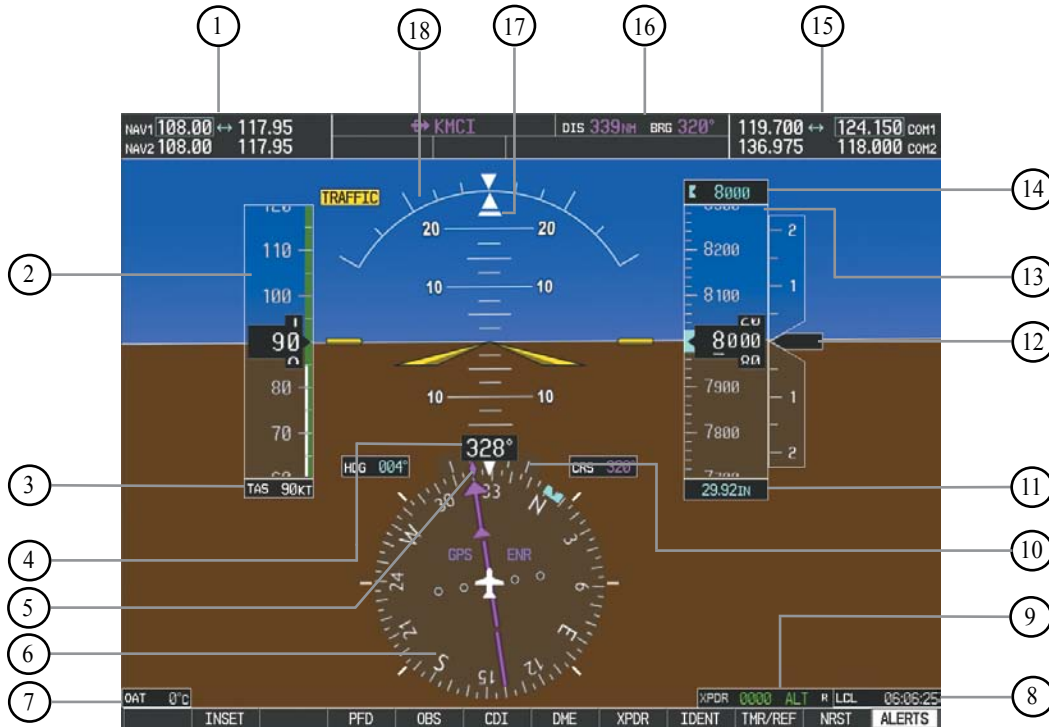

Figure 1-11 Uploading Database to GRS

When the upload is complete, the system is ready for use.

SECTION 2: FLIGHT INSTRUMENTS

The following discussions pertain to the Primary Flight Display, unless otherwise indicated.



- | | |
|----------------------------------|----------------------------|
| ① NAV Frequency Box | ⑩ Turn Rate Indicator |
| ② Airspeed Indicator | ⑪ Barometric Setting Box |
| ③ True Airspeed Box | ⑫ Vertical Speed Indicator |
| ④ Heading Box | ⑬ Altimeter |
| ⑤ Current Track Indicator | ⑭ Selected Altitude Box |
| ⑥ Horizontal Situation Indicator | ⑮ COM Frequency Box |
| ⑦ Outside Air Temperature Box | ⑯ Navigation Status Box |
| ⑧ System Time Box | ⑰ Slip/Skid Indicator |
| ⑨ Transponder Status Box | ⑱ Attitude Indicator |

Figure 2-1 Default PFD Information

SECTION 2 FLIGHT INSTRUMENTS



- ① Traffic Annunciation
- ② Vspeed References
- ③ Selected Heading Box
- ④ Wind Data Window
- ⑤ Inset Map
- ⑥ BRG1 Information Window
- ⑦ DME Information Window
- ⑧ BRG2 Information Window
- ⑨ Flight Plan Window
- ⑩ Barometric Minimums Box
- ⑪ Selected Altitude Bug
- ⑫ Selected Course Box
- ⑬ Barometric Minimums Bug
- ⑭ Vertical Deviation/Glidepath (SBAS enabled systems only)/Glideslope Indicator
- ⑮ Marker Beacon Annunciation

Figure 2-2 Additional PFD Information

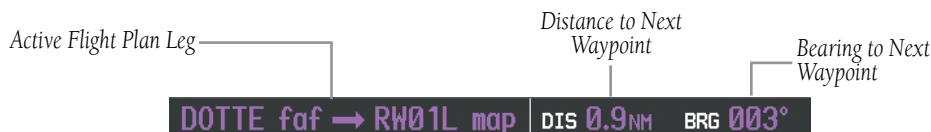

Figure 2-3 PFD Navigation Status Box

2.1 AIRSPEED INDICATOR

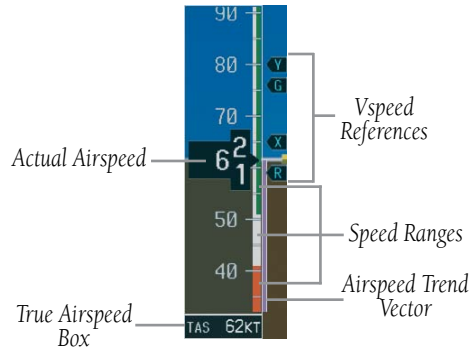

Figure 2-4 Airspeed Indicator

Speed Indication

The indicated airspeed is displayed inside the black pointer. The pointer becomes red upon reaching Vne.



Figure 2-5 Red Pointer at Vne

Speed Ranges

The color coded speed range strip denotes flaps operating range, normal operating range, and never exceed speed (Vne). A red range is also present for low speed awareness. Refer to the Pilot's Operating Handbook (POH) for airspeed limitations and indicator markings.

Airspeed Trend Vector

The end of the trend vector displays approximately what the airspeed will be in 6 seconds if the current rate of acceleration/deceleration is maintained.

Vspeed References

Vspeed References are turned on or off in the Timer/References Window. Press the **TMR/REF** Softkey to display the window. When active (**ON**), the Vspeeds are displayed at their respective locations to the right of the airspeed scale. To activate the Vspeed References, display the Timer/Reference Window and turn the large **FMS** Knob to place the cursor in the ON/OFF field. Turn the small **FMS** Knob to select **ON** or **OFF**.

2.2 ATTITUDE INDICATOR

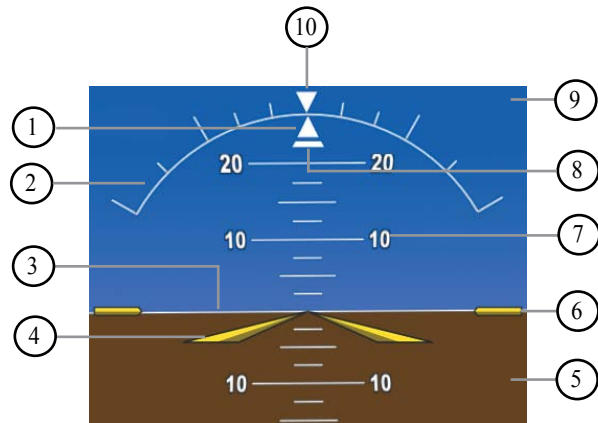

- | | |
|-----------------------|-----------------------|
| ① Roll Pointer | ⑥ Aircraft Wing Tips |
| ② Roll Scale | ⑦ Pitch Scale |
| ③ Horizon Line | ⑧ Slip/Skid Indicator |
| ④ Aircraft Symbol | ⑨ Sky Representation |
| ⑤ Land Representation | ⑩ Roll Index Zero |

Figure 2-6 Attitude Indicator

The Slip/Skid Indicator is located under the roll pointer and moves laterally away from the pointer to indicate lateral acceleration. One Slip/Skid indicator displacement is equal to one ball displacement when compared to a traditional slip/skid indicator.

2.3 ALTIMETER

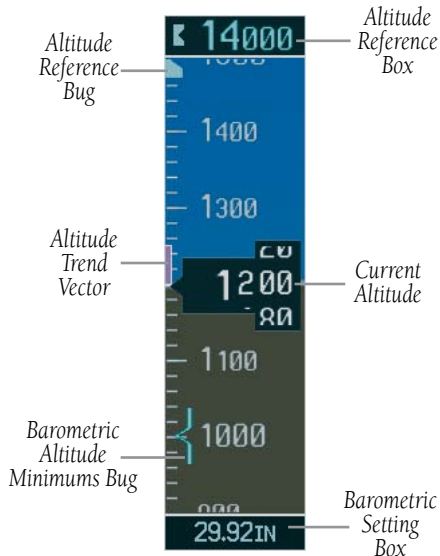

Figure 2-7 Altimeter

Selected Altitude Bug

The Selected Altitude Bug is displayed at the Selected Altitude or the edge of the tape (whichever is closer to the current altitude) to provide increased altitude awareness and to set the desired hold altitude for the autopilot.

Set the Selected Altitude Bug:

Turn the **ALT** Knobs to set the Selected Altitude Bug. The small **ALT** Knob sets the hundreds (50m for metric) and the large **ALT** Knob sets the thousands (500m for metric). This altitude also appears in the Selected Altitude Box above the Altimeter.

Altitude Trend Vector

The end of the trend vector displays approximately what the altitude will be in six seconds if the current rate of vertical speed is maintained.

Barometric Setting Box

Select barometric pressure:

Turn the **BARO** Knob to select the desired setting.

Quickly enter standard pressure:

- 1) Press the **PFD** Softkey.
- 2) Press the **STD BARO** Softkey. STD BARO will now be displayed in the Barometric Setting Box.

Altitude Alerting (GFC700 only)



Figure 2-8 Altitude Alerting Visual Annunciations

Visual annunciations appear in the Altitude Reference Box. Whenever the setting is changed, the Altitude Alerter is reset. The Altitude Alerter is independent of the Automatic Flight Control System.

Metric Display

Display altitude in meters and barometric pressure in hectopascals:

- 1) Press the **PFD** Softkey to display the second level softkeys.
- 2) Press the **ALT UNIT** Softkey.
- 3) Press the **METERS** Softkey to display altitude in meters.
- 4) Press the **HPA** Softkey to display the barometric setting in hectopascals. Press the **IN** Softkey to display the barometric setting in inches of mercury.
- 5) Press the **BACK** Softkey to return to the previous level softkeys.



Figure 2-9 Altimeter (Metric)

Low Altitude Annunciation



NOTE: The **LOWALT** annunciation is only available in G1000 systems configured with SBAS-capable GPS. Also, the **LOW ALT** annunciation is not available when the G1000 is configured with TAWS (Terrain Awareness & Warning System), unless TAWS is inhibited.

When the Final Approach Fix (FAF) is the active waypoint in a GPS SBAS approach using vertical guidance, a **LOW ALT** (Low Altitude) annunciation may appear if the current aircraft altitude is at least 164 feet below the prescribed altitude at the FAF. The annunciation initially flashes. After a few seconds the flashing stops and the annunciation is displayed as shown in Figure 2-10.

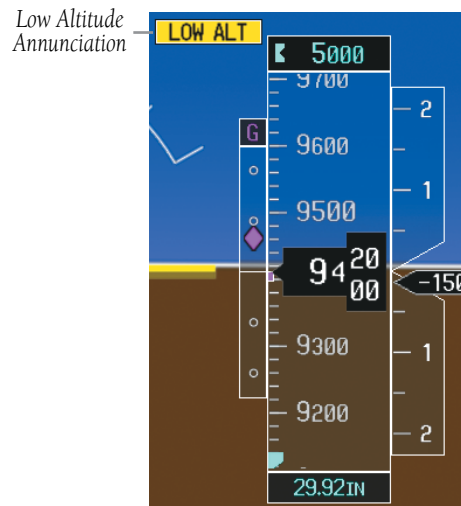

Figure 2-10 Low Altitude on GPS Approach

**2.4 VERTICAL DEVIATION/GLIDEPATH/
GLIDESLOPE INDICATOR**

The Vertical Deviation and Required Vertical Speed Indicators appear when vertical guidance is being given prior to executing an approach (see Figure 2-11). In systems that are SBAS enabled, the Glidepath Indicator appears at a point prior to the FAF when executing an LPV, LNAV/VNAV, or LNAV+V approach (see Figure 2-12).

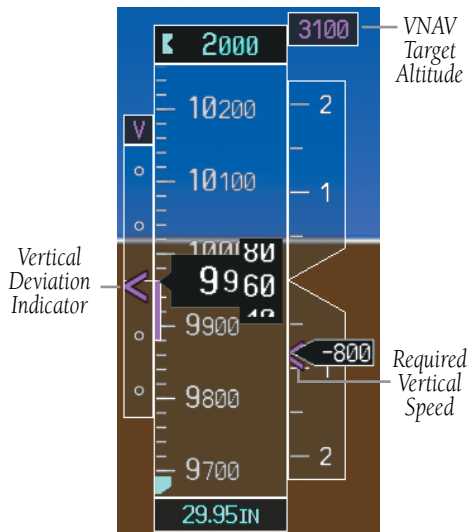

Figure 2-11 Vertical Deviation Indications

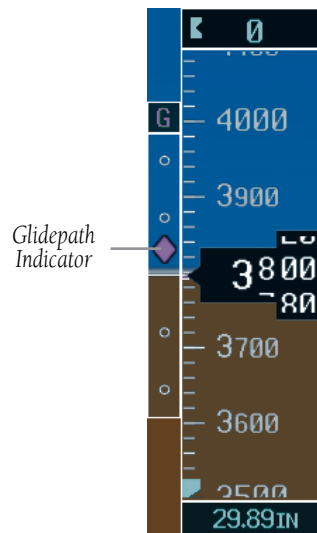

Figure 2-12 Glidepath Indicator

The Glideslope Indicator appears when an ILS is tuned in the active NAV receiver field, selected for display on the HSI, and the aircraft heading is within 105° of the approach course (see Figure 2-13).

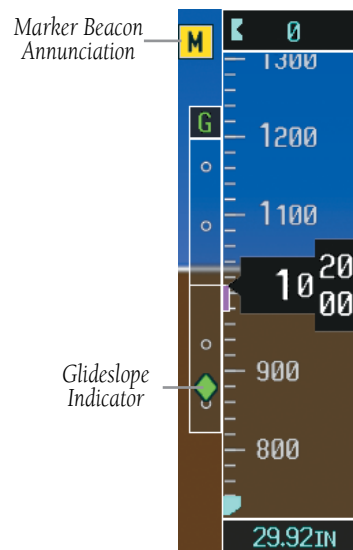

Figure 2-13 Glideslope Indicator

2.5 MARKER BEACON ANNUNCIATIONS

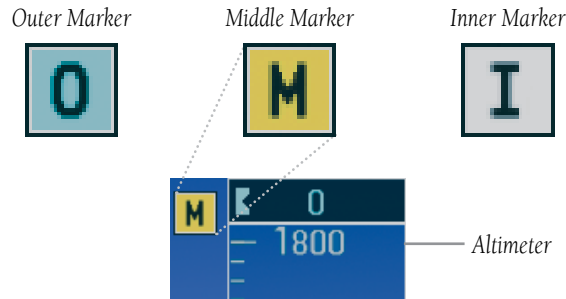

Figure 2-14 Marker Beacon Annunciations

2.6 VERTICAL SPEED INDICATOR

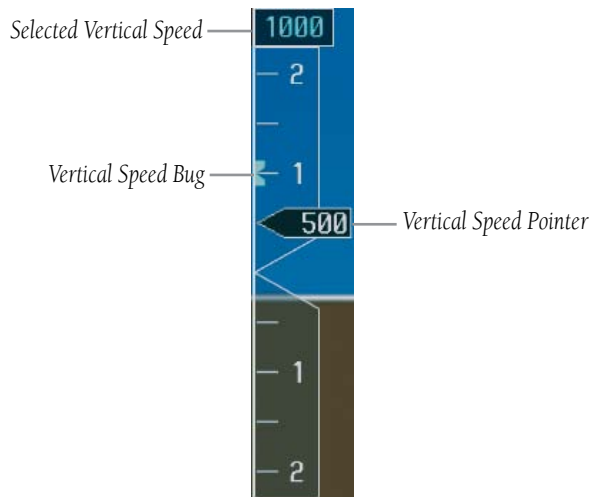

Figure 2-15 Vertical Speed Indicator

The actual vertical speed is displayed inside the pointer.

When the Flight Director is placed in Vertical Speed Mode (by pressing the **VS** Key) the Vertical Speed Bug is displayed. Press the **NOSE UP** or **NOSE DN** Key to adjust.

2.7 BAROMETRIC ALTITUDE MINIMUMS

The desired barometric altitude minimums can be set in the Timer/References Window. The altitude ranges from 0 to 16,000 feet in 10-foot increments. The minimums are reset anytime the power is cycled.



Figure 2-16 Barometric Minimum Descent Altitude Settings

The desired barometric minimum descent altitude (MDA, DA, DH) can be set in the Timer/References Window.

Visual annunciations alert the pilot when approaching the MDA:

- When the aircraft altitude descends to within 2500 feet of the MDA setting, the Barometric Minimum Box appears with the altitude in light blue text. The bug appears on the tape in light blue once in range.
- When the aircraft passes through 100 feet of the MDA, the bug and text turn white.
- Once the aircraft descends past the MDA, the bug and text turn yellow and the aural alert, “Minimums Minimums”, is generated.

Alerting is inhibited while the aircraft is on the ground. If the aircraft climbs after having reached the MDA, once it reaches 50 feet above the MDA, alerting is disabled.

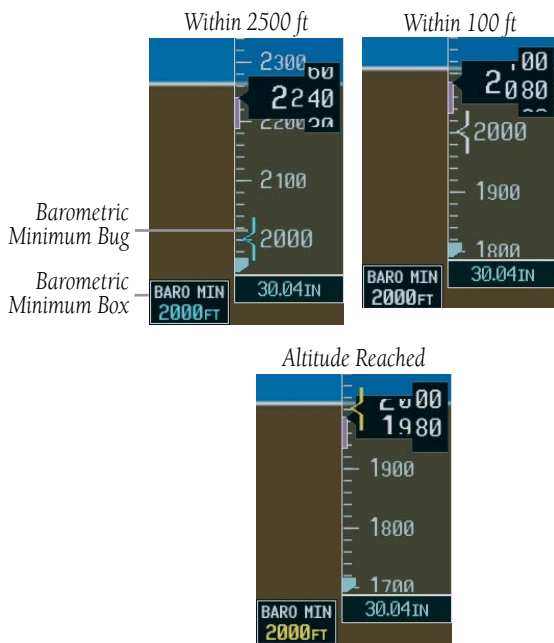

Figure 2-17 Barometric Minimum Descent Altitude Alerting Visual Annunciations

Set the barometric altitude minimums:

- 1) Press the **TMR/REF** Softkey.
- 2) Turn the large **FMS** Knob to highlight the 'Minimums' field (Figure 2-16).
- 3) Turn the small **FMS** Knob to select **BARO**. **OFF** is selected by default. Press the **ENT** Key or turn the large **FMS** Knob to highlight the next field.
- 4) Use the small **FMS** Knob to enter the desired altitude (from zero to 16,000 feet).
- 5) To remove the window, press the **CLR** Key or the **TMR/REF** Softkey.

2.8 HORIZONTAL SITUATION INDICATOR (HSI)

The HSI compass can be displayed as a 360° rose or 140° arc by pressing the **PFD** Softkey, followed by the

HSI FRMT Softkey, followed by the **360 HSI** or the **ARC HSI** Softkey.

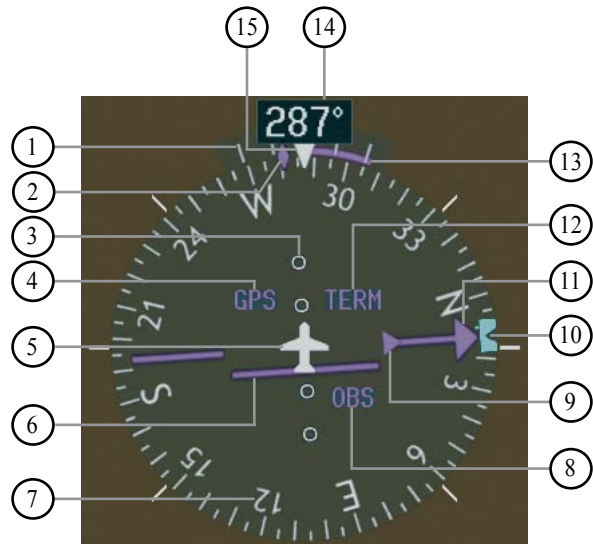

- ① Turn Rate Indicator
- ② Current Track Indicator
- ③ Lateral Deviation Scale
- ④ Navigation Source
- ⑤ Aircraft Symbol
- ⑥ Course Deviation Indicator
- ⑦ Rotating Compass Rose
- ⑧ OBS Mode
- ⑨ TO/FROM Indicator
- ⑩ Heading Bug
- ⑪ Course Pointer
- ⑫ Flight Phase
- ⑬ Turn Rate and Heading Trend Vector
- ⑭ Heading
- ⑮ Lubber Line

Figure 2-18 Horizontal Situation Indicator

Turn Rate Indicator and Heading Trend Vector

Tick marks to the left and right of the lubber line denote half-standard and standard turn rates. A magenta turn rate trend vector shows the current turn rate. The end of the trend vector gives the heading predicted in six seconds, based on the present turn rate. At rates greater than 4 deg/sec, an arrowhead appears at the end of the magenta trend vector and the prediction is no longer valid.

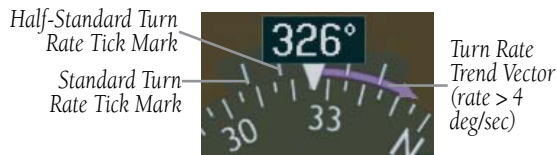

Figure 2-19 Turn Rate Indicator and Trend Vector



Figure 2-20 Standard-Rate Turn Indication

Course Pointer

The course pointer is a single line arrow (GPS, VOR1 and LOC1) or double line arrow (VOR2 and LOC2) which points in the direction of the set course.



Figure 2-21 Course Pointer

Course Deviation Indicator (CDI)

The CDI scale automatically adjusts to the current phase of flight as seen in Figure 2-22. Scaling may be selected manually from the MFD System Setup Page.

Flight Phase	Automatic CDI Full-scale Deflection
Departure (DRPT)	0.3 nm
Terminal (TERM)	1.0 nm
Enroute (ENR)	2.0 nm
Oceanic (OCN)	2.0 nm
Approach (LNAV)	1.0 nm decreasing to 350 feet depending on variables (see Figure 2-23)
Approach (LNAV+V) (SBAS systems only)	
Approach (LNAV/VNAV)(SBAS only)	1.0 nm decreasing to a specified course width, then 0.3 nm, depending on variables (see Figure 2-24)
Approach (LPV) (SBAS only)	
Missed Approach	0.3 nm

Table 2-1 CDI Scale

SECTION 2 FLIGHT INSTRUMENTS

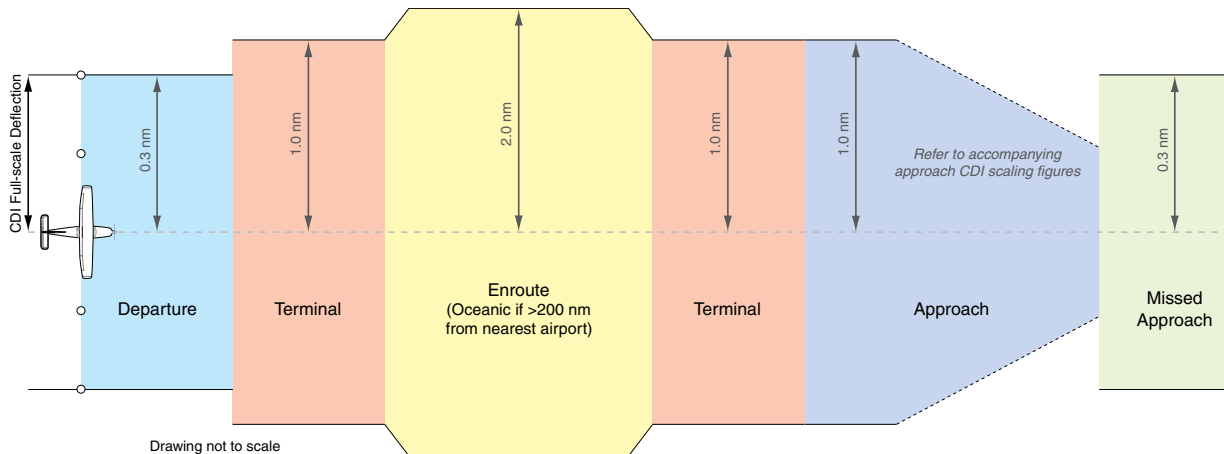

Figure 2-22 Phases of Flight/CDI Scaling

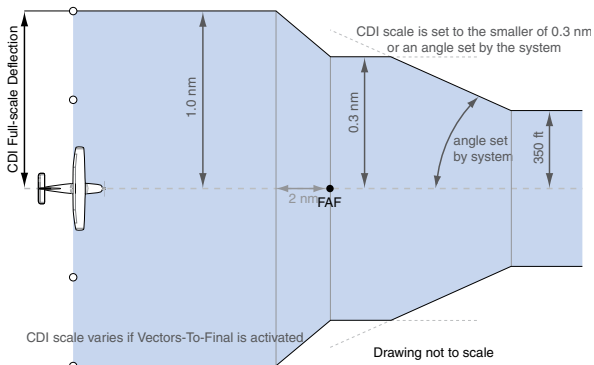

Figure 2-23 Typical LNAV and LNAV+V Approach CDI Scaling

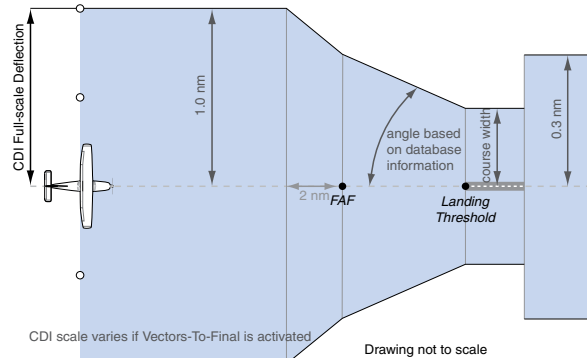

Figure 2-24 Typical LNAV/VNAV and LPV Approach CDI Scaling (SBAS Systems Only)

Bearing Pointers and Information Windows

Pressing the **PFD** Softkey provides access to the **BRG1** and **BRG2** Softkeys. The BRG1 pointer is a single line pointer. The BRG2 pointer is a double line pointer. Press the **BRG1** or **BRG2** Softkey to cycle through selecting NAV1/2, GPS, or ADF for display using the corresponding pointer.

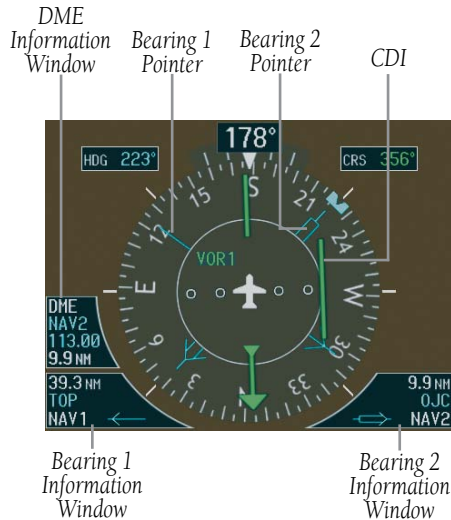

Figure 2-25 HSI with Bearing Information

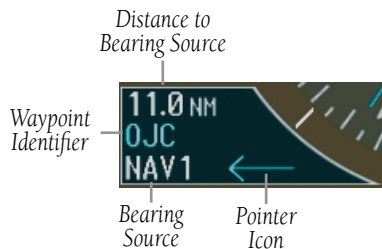

Figure 2-26 BRG1 Information Window

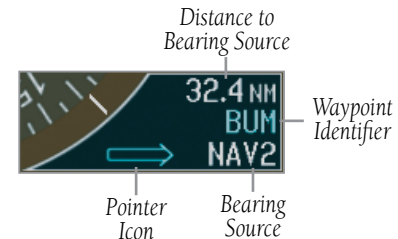

Figure 2-27 BRG2 Information Window

DME (optional)

To display the DME Information Window, press the **PFD** Softkey followed by the **DME** Softkey.



Figure 2-28 DME Information Window

Navigation Source

Change CDI navigation sources:

- 1) Press the **CDI** Softkey to change from GPS to VOR1/LOC1.
- 2) Press the **CDI** Softkey again to change from VOR1/LOC1 to VOR2/LOC2.
- 3) Press the **CDI** Softkey a third time to return to GPS.

When using GPS as the navigation source, the following may appear:

- LOI - GPS position integrity is inadequate for the current procedure being flown. If GPS is being used as primary navigation, and LOI is annunciated, other means of primary navigation is required, such as VHF. LOI is also displayed during GPS position initialization.
- WARN – GPS detects a position error.

- OBS – Displayed when operating in OBS Mode.
- SUSP – Displayed when in OBS Mode indicating GPS waypoint sequencing is suspended.
- DR – Navigating using Dead Reckoning due to an error in the GPS solution.



Figure 2-29 GPS LOI, GPS SUSP, LOC1 and VOR2

Enable/disable OBS Mode while navigating with GPS:

- 1) Press the **OBS** Softkey to select OBS Mode.
- 2) Turn the **CRS** Knob to select the desired course to/from the waypoint.
- 3) Press the **OBS** Softkey again to disable OBS Mode.



NOTE: The **OBS** Softkey is only displayed when navigating an active leg using GPS.

2.9 WIND DATA

When the window is selected for display, but wind information is invalid or unavailable, the window shows “NO WIND DATA”. Wind data can be displayed in three different ways:

- Wind direction arrows with headwind and crosswind components (Option 1)
- Wind direction arrow and speed (Option 2)
- Wind direction arrow with direction and speed (Option 3)

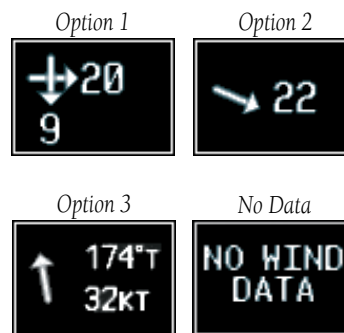

Figure 2-30 Wind Data Window

Displaying wind data:

- 1) Press the **PFD** Softkey.
- 2) Press the **WIND** Softkey to display wind data below the Selected Heading.
- 3) Press one of the **OPTN** softkeys to change how wind data is displayed.
- 4) To remove the Wind Data Window, press the **OFF** Softkey.

2.10 GENERIC TIMER

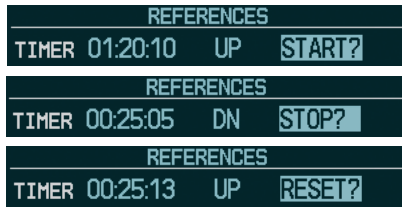

Figure 2-31 Timer Status Prompts

Change the Generic Timer:

- 1) Press the **TMR/REF** Softkey, then turn the large **FMS** Knob to select the time field (hh/mm/ss). Turn the **FMS** Knobs to set the desired time, then press the **ENT** Key. The UP/DOWN field is now highlighted.
- 2) Turn the small **FMS** Knob to display the UP/DOWN window. Turn the **FMS** Knob to select 'UP' or 'DOWN', then press the **ENT** Key. 'START?' is now highlighted.
- 3) Press the **ENT** Key to START, STOP, or RESET the timer (if the timer is counting DOWN, it must be reset manually). Press the **CLR** Key or the **TMR/REF** Softkey to remove the window.

Blank Page

SECTION 3: ENGINE INDICATION SYSTEM (EIS)



NOTE: Refer to the *Pilot's Operating Handbook (POH)* for limitations.

EIS information is presented in three displays, accessed using the **ENGINE** Softkey on the MFD.

The 172R, 172S, 182T, 206H, T182T, and T206H display the following:

- **Engine Display** – Default display, shows all critical engine, fuel, and electrical indicators
- **Lean Display** – Provides engine leaning information
- **System Display** – Shows numeric readouts of critical engine, fuel, and electrical indicators

Green and white bands indicate normal ranges of operation; yellow and red bands indicate caution and warning, respectively. If sensory data to an instrument becomes invalid or unavailable, a red “X” is shown across the instrument.

3.1 ENGINE DISPLAY

The Engine Display is the default EIS display and can be displayed after viewing other EIS displays by pressing the **ENGINE** Softkey.

The EIS automatically defaults back to the Engine Display from the Lean or System Display when certain parameters are exceeded. Fluctuations in engine speed and fuel quantity above certain levels, depending on the airframe, also cause reversion back to the Engine Display.

- 1 **Engine Manifold Pressure Gauge (MAN IN)**
Models 182T, T182T, 206H, T206H – Displays engine power in inches of mercury (in Hg). Turbocharged aircraft have a red portion of the gauge indicating the maximum manifold pressure

range. A white tick mark is displayed indicating the cruise manifold pressure (*Model T182T only*).

- 2 **Tachometer (RPM)** – Shows propeller speeds in revolutions per minute (rpm). Red range indicates propeller overspeed warning; a white high-rpm range indicates above normal operating speeds (*Models 172S, 206H, and T206H*).

Model 172S – When ascending through 5300 ft, the upper end of the green arc displays 2600 rpm and ascending through 10,300 displays 2700 rpm. When descending below 9700 ft, the upper end of the green arc returns to 2600 rpm and descending below 4700 ft returns to 2500 rpm.

- 3 **Fuel Flow Indicator (FFLOW GPH)** – Shows the current fuel flow in gallons per hour (gph). For turbocharged aircraft, the indicator displays a small stand-alone green band indicating maximum takeoff fuel flow. A white tick mark indicates the maximum cruise fuel flow (*Model T182T only*).

- 4 **Oil Pressure Indicator (OIL PRES)** – Displays pressure of the oil supplied to the engine in pounds per square inch (psi).

- 5 **Oil Temperature Indicator (OIL TEMP)** – Displays the engine oil temperature in degrees Fahrenheit (°F).

- 6 **Cylinder Head Temperature Indicator (CHT)**
Models 182T, T182T, 206H, T206H – Shows the head temperature of the hottest cylinder (number shown in triangular pointer) in degrees Fahrenheit (°F).

SECTION 3 – ENGINE INDICATION SYSTEM (EIS)

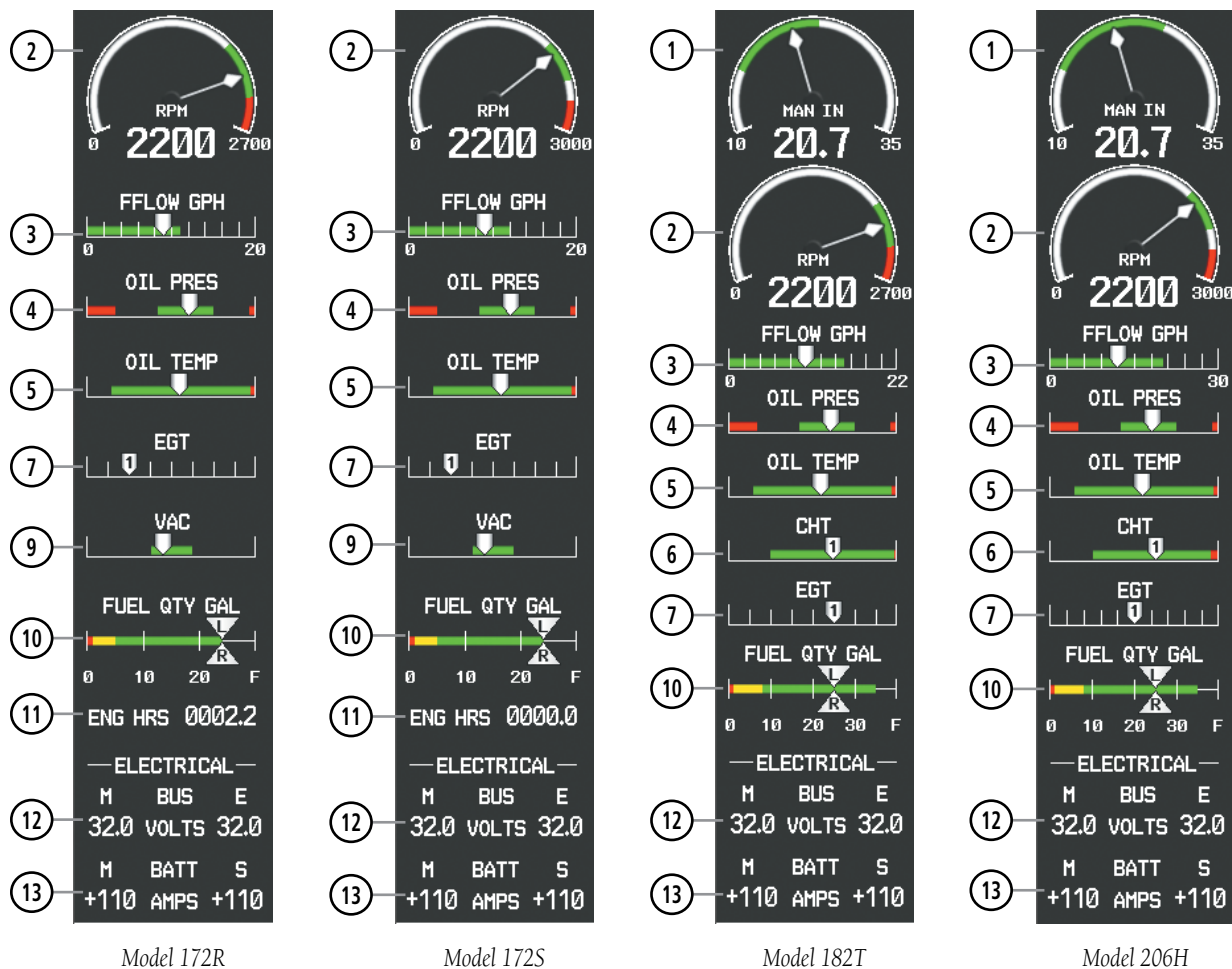

Figure 3-1 Engine Display (Normally-aspirated Aircraft)

- ⑦ **Exhaust Gas Temperature Indicator (EGT)**
Normally-aspirated Aircraft – Displays the exhaust gas temperature of the hottest cylinder (number shown in triangular pointer) in degrees Fahrenheit (°F).
- ⑧ **Turbine Inlet Temperature Indicator (TIT)**
Turbocharged Aircraft – Displays the temperature at the turbine inlet in degrees Fahrenheit (°F).
- ⑨ **Vacuum Pressure Indicator (VAC)** *Models 172R and 172S* – Displays vacuum pressure.
- ⑩ **Fuel Quantity Indicator (FUEL QTY GAL)**
– Shows the quantity of fuel in the tanks, in gallons, ranging from zero to full (F) for each fuel tank (left–L and right–R). When full, the indicator displays to 35 gallons per side (26 gallons for the *Models 172R and 172S*).

- ⑪ **Engine Hours (Tach) (ENG HRS)** *Models 172R and 172S* – A numeric readout gives the time (in hours) the engine has been in service.
- ⑫ **Voltmeter (M, E BUS VOLTS)** – Displays the main and essential bus voltages.
- ⑬ **Ammeter (M, S BATT AMPS)** – Shows the main and standby battery load in amperes.

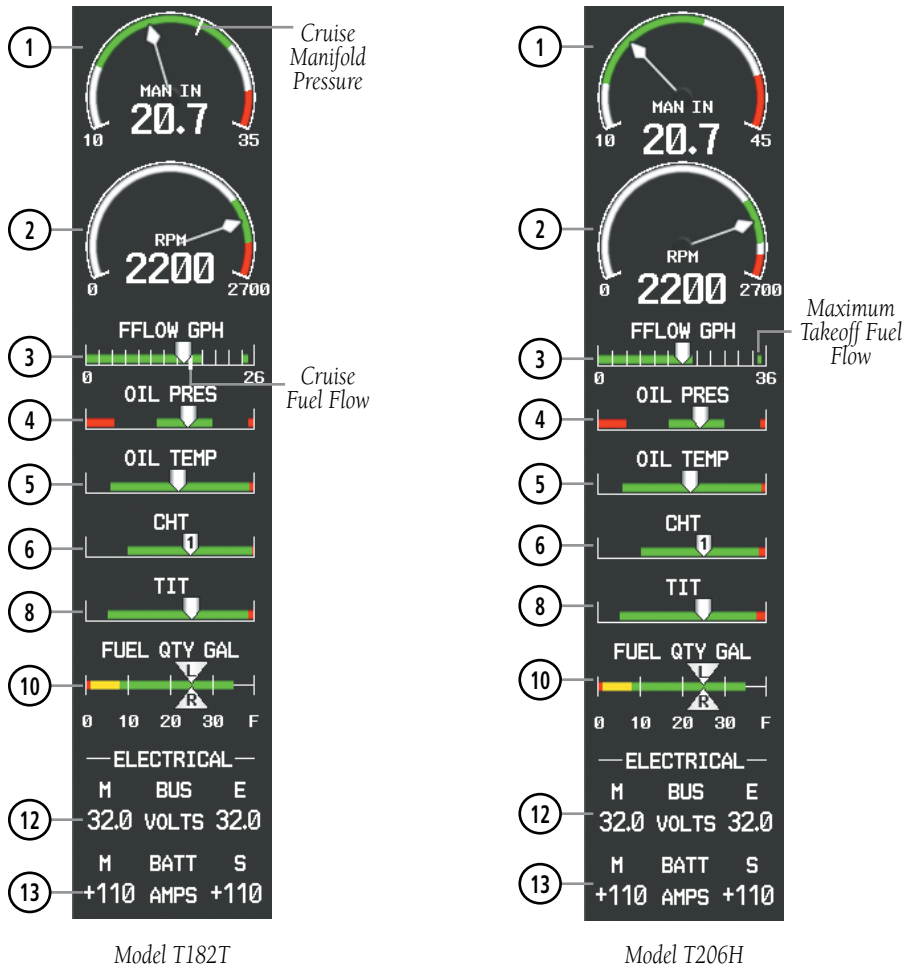

Figure 3-2 Engine Display (Turbocharged Aircraft)

3.2 LEAN DISPLAY



NOTE: *The pilot should follow the engine manufacturer's recommended leaning procedures in the Pilot's Operating Handbook (POH).*

- ① **Engine Manifold Pressure Gauge (MAN IN)**
Models 182T, T182T, 206H, T206H – Displays engine power in inches of mercury (in Hg). Turbocharged aircraft have a red portion of the gauge indicating the maximum manifold pressure range. A white tick mark is displayed indicating the cruise manifold pressure (*Model T182 only*).
- ② **Tachometer (RPM)** – Shows propeller speeds in revolutions per minute (rpm). Red range indicates propeller overspeed warning; a white high-rpm range indicates above normal operating speeds (*Models 172S, 206H and T206H*).
- ③ **Fuel Flow (FFLOW GPH)** – Shows the current fuel flow in gallons per hour (gph).
- ④ **Turbine Inlet Temperature Indicator (TIT)** *Models T182T and T206H* – Displays the temperature at the turbine inlet in degrees Fahrenheit (°F). When the **ASSIST** Softkey is pressed, the TIT deviation from peak (Δ PEAK) is displayed below the indicator.
- ⑤ **Exhaust Gas Temperature Bar Graph (EGT °F)** – Displays the exhaust gas temperature of all cylinders in degrees Fahrenheit (°F); a readout for the selected cylinder (by default, the hottest cylinder) is shown below the bar graph. The selected cylinder is indicated by a light blue box around the cylinder number. Cylinders whose EGTs are in the normal range appear in white. For normally aspirated models, pressing the **ASSIST** Softkey causes the EGT deviation from peak (Δ PEAK) for the selected cylinder to be displayed below the indicator.
- ⑥ **Cylinder Head Temperature Indicator (CHT)**
– Shows the head temperatures of all cylinders in degrees Fahrenheit (°F); a readout for the selected cylinder (by default, the hottest cylinder) is shown below the bar graph. The selected cylinder is indicated by a light blue box around the cylinder number. Cylinders whose CHTs are in the normal range appear in white. Cylinders whose CHTs enter the warning ranges appear in red.
- ⑦ **Fuel Quantity Indicator (FUEL QTY GAL)**
– Shows the quantity of fuel in the left and right fuel tanks (left–L and right–R). When full, the indicator displays to 35 gallons per side (26 gallons for the *Models 172R and 172S*).

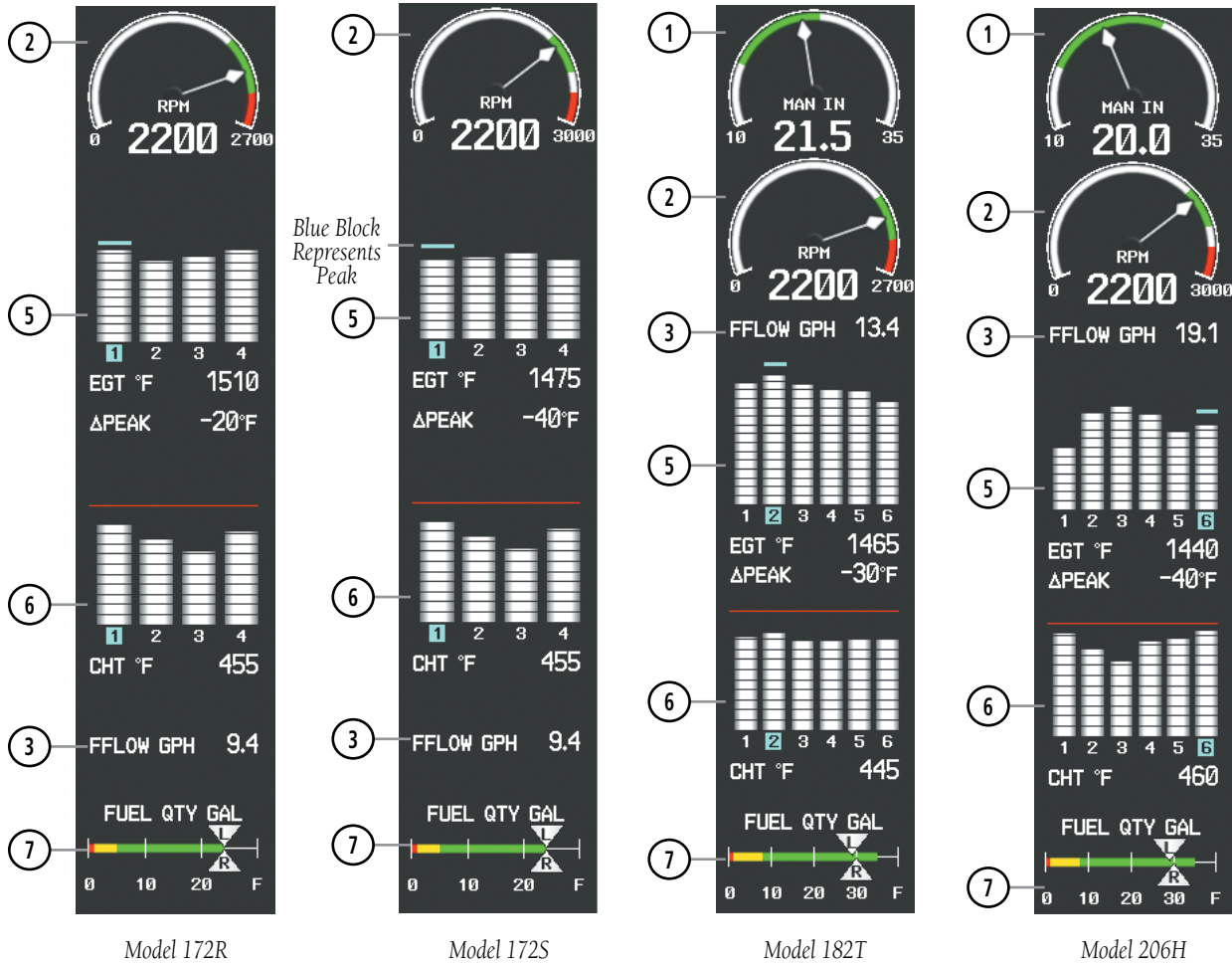

Figure 3-3 Lean Display (Normally-aspirated Aircraft)

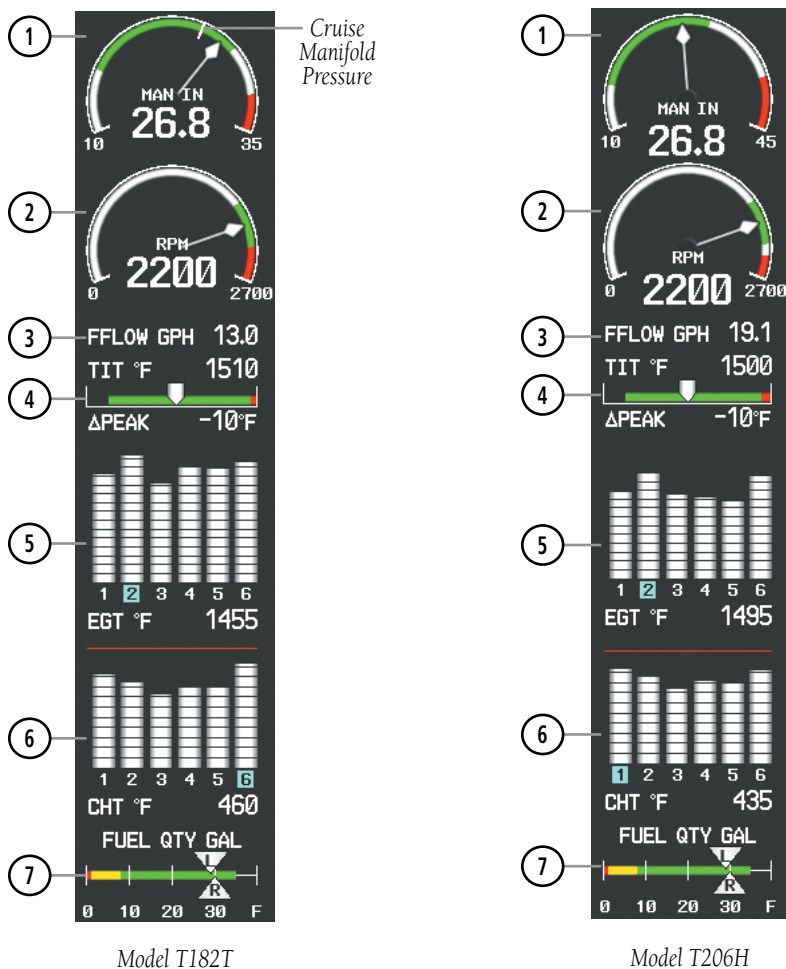

Figure 3-4 Lean Display (Turbocharged Aircraft)

The Lean Display is accessed by pressing the **ENGINE** Softkey followed by the **LEAN** Softkey and provides information for performing engine leaning.

From the Lean Display, the pilot can utilize the **CYL SLCT** and **ASSIST** softkeys to obtain information about specific cylinders. Pressing the **CYL SLCT** (Cylinder Select) Softkey cycles through the cylinders (i.e., places a light blue box around the cylinder number). This softkey is disabled when the **ASSIST** Softkey is pressed or when a cylinder experiences a caution or warning condition; the softkey remains disabled until the temperature returns to normal.

The **ASSIST** Softkey aids in the leaning process by identifying the peak of the first cylinder whose temperature falls. If the temperature of the peaked cylinder exceeds the peak value, the peak value is not updated. Press the **ASSIST** Softkey to stop peak monitoring.

Normally-aspirated Aircraft

For normally-aspirated aircraft, when a cylinder peaks, its peak is represented by a hollow block on the EGT Bar Graph. The EGT readout for the peaked cylinder, indicated on the bar graph in light blue, appears directly beneath the bar graph. The system automatically switches to the first peak obtained and displays the temperature deviation from peak (Δ PEAK) in degrees Fahrenheit ($^{\circ}$ F) below the EGT readout.

Turbocharged Aircraft

Leaning for turbocharged aircraft is done with reference to the Turbine Inlet Temperature (TIT). When the temperature peaks, the numeric readout (Δ PEAK) appears below the TIT Indicator and displays the difference between peak and current TITs, in degrees Fahrenheit ($^{\circ}$ F). If a peak is not displayed, underscores are shown until one is established.

3.3 SYSTEM DISPLAY



NOTE: Fuel calculations do not use the aircraft fuel quantity indicators and are calculated from the last time the fuel was reset.



NOTE: The pilot should refer to the Pilot's Operating Handbook (POH) for fuel values and limitations. The displayed fuel remaining can be adjusted up to 53 gal (Models 172R, 172S) or 87 gal (Models 182T, T182T, 206H, T206H).

The System Display is accessed by pressing the **ENGINE** Softkey followed by the **SYSTEM** Softkey and shows critical engine, fuel, and electrical parameters.

Fuel calculations are based on the fuel flow totalizer and the displayed fuel remaining, adjusted by the pilot using the following softkeys:

- **RST FUEL** – Resets totalizer-based fuel remaining (GAL REM) to zero and the fuel used (GAL USED) to zero
- **GAL REM** – Gives access to softkeys for adjusting the amount of fuel remaining for purposes of fuel calculations

Fuel remaining can be adjusted in one or ten-gallon increments using the appropriate softkeys. Softkeys also allow entering the full tank quantity for the aircraft or the tab quantity, which is 35 gallons (Models 172R and 172S) or 64 gallons (Models 182T, T182T, 206H, and T206H).

- 1 **Engine Manifold Pressure Gauge (MAN IN)**
Models 182, T182, 206, T206 – Displays engine power in inches of mercury (in Hg). Turbocharged aircraft have a red portion of the gauge indicating the maximum manifold pressure range. A white tick mark is displayed indicating the cruise manifold pressure (Model T182 only).
- 2 **Tachometer (RPM)** – Shows propeller speeds in revolutions per minute (rpm). Red range indicates propeller overspeed warning; a white high-rpm range indicates above normal operating speeds (Models 172S, 206 and T206).
- 3 **Oil Pressure (OIL PSI)** – Displays pressure of the oil supplied to the engine in pounds per square inch (psi).

SECTION 3 – ENGINE INDICATION SYSTEM (EIS)

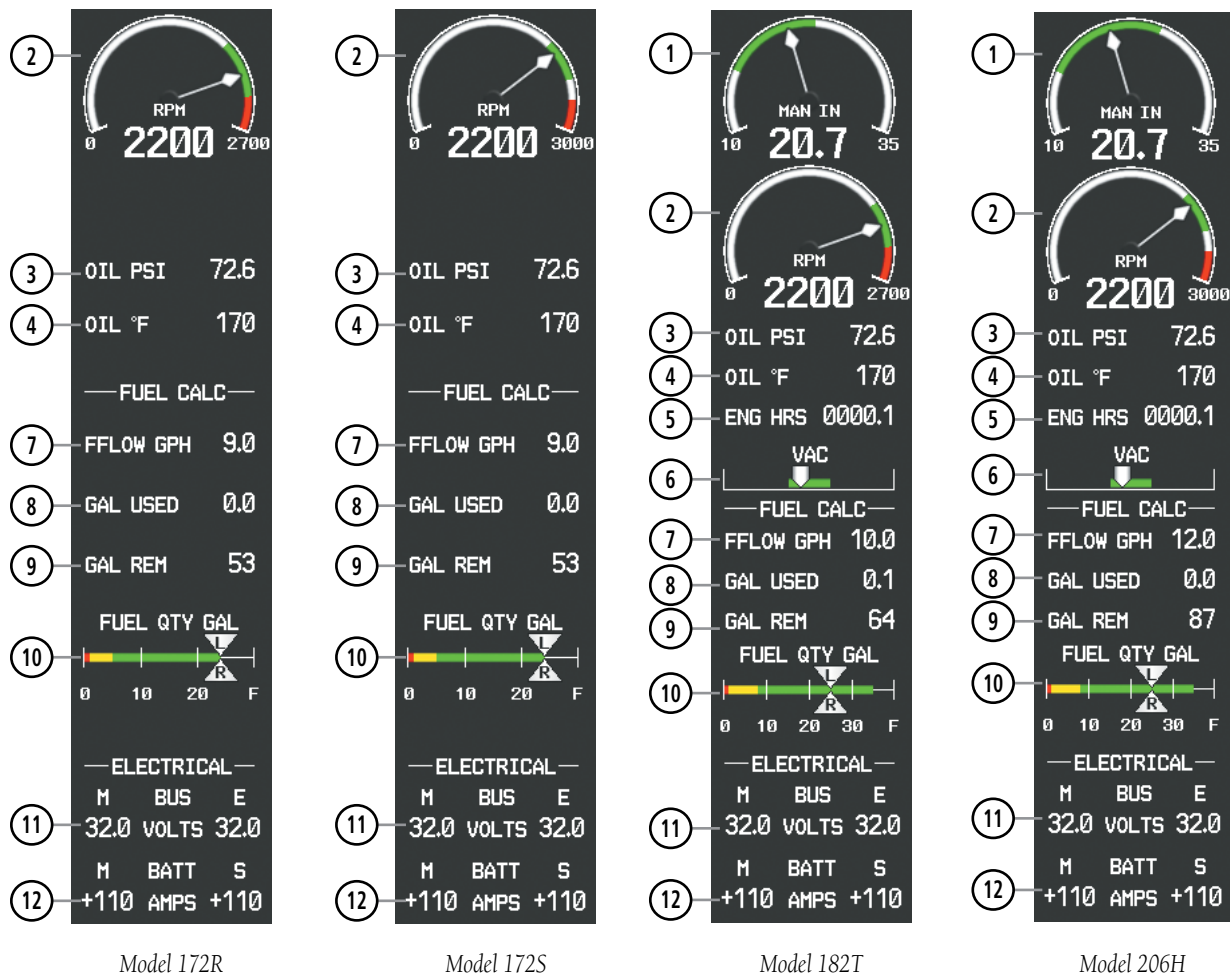

Figure 3-5 System Display (Normally-aspirated Aircraft)

- ④ **Oil Temperature (OIL °F)** – Displays the engine oil temperature in degrees Fahrenheit (°F).
- ⑤ **Engine Hours (Tach) (ENG HRS)** Models 182, T182, 206, T206 – A numeric readout gives the time (in hours) the engine has been in service.
- ⑥ **Vacuum Pressure Indicator (VAC)** Models 182, T182, 206, T206 – Displays vacuum pressure.
- ⑦ **Fuel Flow (FFLOW GPH)** – Shows the current fuel flow in gallons per hour (gph).
- ⑧ **Calculated Fuel Used (GAL USED)** – Shows quantity of fuel used in gallons based on fuel flow since last reset.

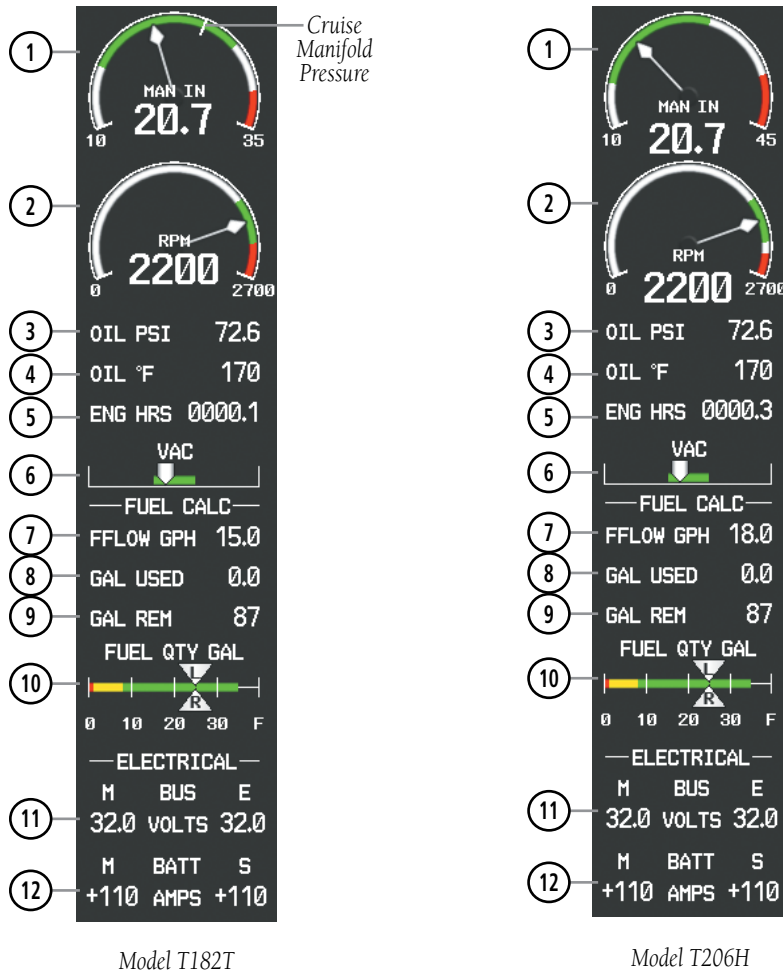
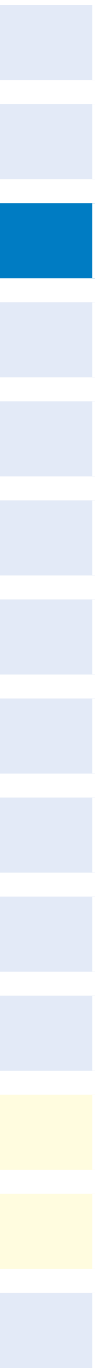

Figure 3-6 System Display (Turbocharged Aircraft)

- ⑨ **Set Fuel Remaining (GAL REM)** – Shows current fuel remaining in gallons as set by the pilot and adjusted for fuel burn since last set.
- ⑩ **Fuel Quantity Indicator (FUEL QTY GAL)** – Shows the quantity of fuel in the tanks, in gallons, ranging from zero to full (F) for each fuel tank (left–L and right–R). When full, the indicator displays to 35 gallons per side (24 gallons for the Models 172R and 172S).
- ⑪ **Voltmeter (M, E BUS VOLTS)** – Displays the main and essential bus voltages.
- ⑫ **Ammeter (M, S BATT AMPS)** – Shows the main and standby battery load in amperes.



Blank Page

SECTION 4: NAV/COM AND TRANSPONDER

The NAV/COM controls and frequency boxes share the same locations on the on the Primary Flight Display and the Multi-Function Display.



Figure 4-1 G1000 VHF NAV/COM Interface (PFD shown)

DME Tuning Window

SECTION 4 – NAV/COM & TRANSPONDER

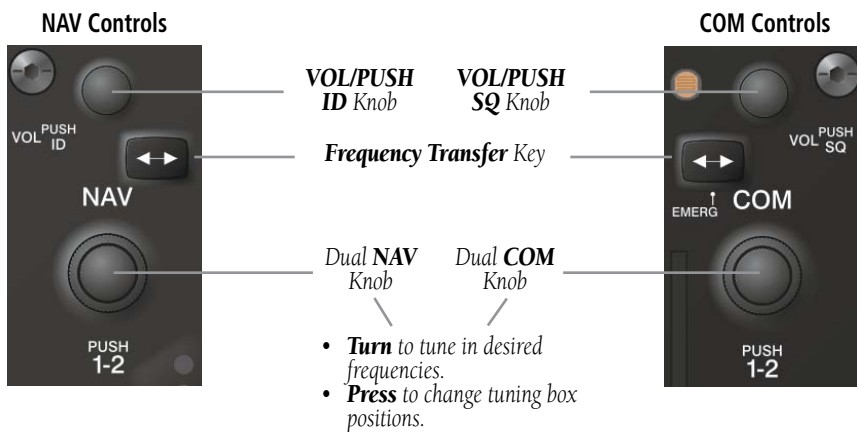
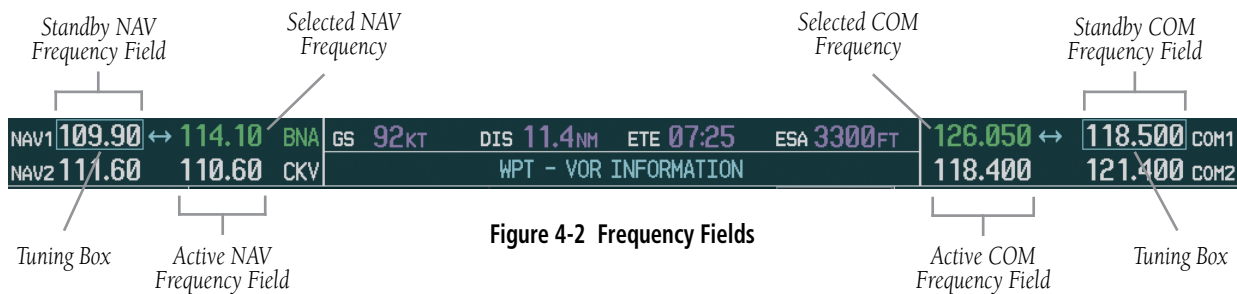

Figure 4-4 NAV/COM Controls

4.1 RADIO STATUS INDICATIONS

- **RX** – When a COM signal is received, a white 'RX' appears by the active COM frequency during signal reception.
- **TX** – When a COM radio is transmitting, a white 'TX' indication appears to the right of the corresponding COM frequency.
- **ID** – When the Morse code identifier is ON for a NAV radio, a white 'ID' indication appears to the left of the corresponding active NAV frequency. The Morse code identifier can be heard if the corresponding NAV radio is selected on the audio panel.

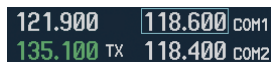

Figure 4-5 Radio Status Indications

4.2 VOLUME

'VOLUME' is displayed in place of the associated radio name (i.e., 'COM1' or 'NAV2') for two seconds after the volume level is last changed. The percentage of maximum volume is displayed in place of the standby frequency selected by the tuning box.

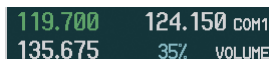

Figure 4-6 COM Volume Level

4.3 AUTOMATIC SQUELCH

Automatic squelch can be disabled for a COM radio by pressing the **COM** Knob to place the tuning box on the desired COM's standby frequency, then by pressing the **VOL/PUSH SQ** Knob.

When Automatic Squelch is disabled, a white 'SQ' appears next to the COM frequency.

Squelch
Indication

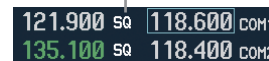

Figure 4-7 Squelch Indication

4.4 QUICKLY ACTIVATING 121.500 MHZ

Pressing and holding the **COM Frequency Transfer** Key for approximately two (2) seconds automatically tunes the selected COM radio to the emergency frequency.

4.5 OPTIONAL NAV RADIOS

DME Radio (optional)

The DME Tuning Window is displayed by pressing the **DME** Softkey.

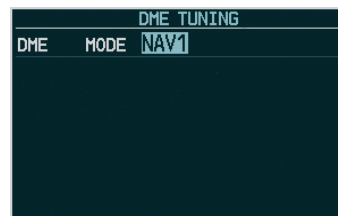

Figure 4-8 Radio Tuning Window

Changing the DME tuning source:

- 1) From the tuning window, turn the large **FMS** Knob to highlight the DME source field.
- 2) Turn the small **FMS** Knob to display the selection window. Turn the **FMS** Knob to select the desired mode and press the **ENT** Key.



Figure 4-9 DME Selection Window

ADF Radio (optional)

The G1000 does not support tuning of the ADF in Nav III aircraft. ADF tuning is accomplished through the Bendix/King KR 87 ADF Radio. ADF volume must also be adjusted through the KR 87.

4.6 FREQUENCY AUTO-TUNING

Auto-tuning on the PFD

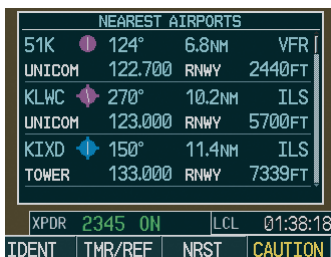

Figure 4-10 Nearest Airports Window (PFD)

- 1) Press the **NRST** Softkey to display the Nearest Airports Window.
- 2) Turn either **FMS** Knob to highlight the desired frequency.
- 3) Press the **ENT** Key to place the frequency in the standby field of the active COM.
- 4) Press the **Frequency Transfer** Key to place the frequency in the active field.

NAV frequencies are entered automatically in the NAV frequency active or standby field (depending in CDI selection) upon approach loading or approach activation.

Auto-tuning on the MFD

Auto-tuning on the MFD is done in much the same way as on the PFD. Use the **FMS** Knobs to select the desired frequency on any of the information pages. Pressing the **ENT** Key then loads the selected frequency in the tuning box as a standby frequency.

4.7 TRANSPONDER

Mode Selection

The **STBY**, **ON**, **ALT**, **GND**, **VFR**, **CODE**, and **IDENT** Softkeys can be accessed by pressing the **XPDR** Softkey.

Ground Mode (Automatic or Manual)

GND is displayed when the aircraft is on the ground or when the **GND** Softkey is pressed. The transponder does not allow Mode A and Mode C replies, but it does permit acquisition squitter and replies to discretely address Mode S interrogations.

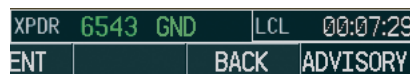

Figure 4-11 Ground Mode

Standby Mode (Manual)

Press the **STBY** Softkey. In Standby Mode, the transponder does not reply to interrogations, but new codes can be entered.

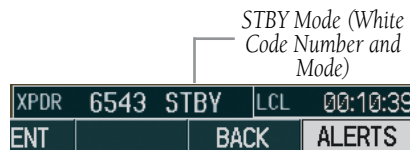

Figure 4-12 Standby Mode

Manual ON Mode

Press the **ON** Softkey. ON Mode generates Mode A and Mode S replies, but Mode C altitude reporting is inhibited.



Figure 4-13 ON Mode

Altitude Mode (Automatic or Manual)

Altitude Mode is automatically selected when the aircraft becomes airborne. Altitude Mode may also be selected manually by pressing the **ALT** Softkey.

All transponder replies requesting altitude information are provided with pressure altitude information.

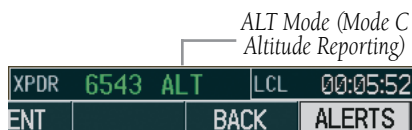

Figure 4-14 Altitude Mode

Reply Status

When the transponder sends replies to interrogations, an “R” indication appears momentarily in the reply status field.



Figure 4-15 Reply Indication

Code Selection

VFR Code Selection

- 1) Press the **XPDR** Softkey to display the transponder Mode Selection softkeys.
- 2) Press the **VFR** Softkey to enter the VFR code. Pressing the **VFR** Softkey again restores the previous identification code.



NOTE: The pre-programmed VFR Code is set at the factory to 1200.

Enter Code Using Softkeys

- 1) Press the **XPDR** Softkey to display the transponder Mode Selection softkeys.
- 2) Press the **CODE** Softkey to display the transponder Code Selection softkeys, which includes the digit softkeys.
- 3) Press the appropriate digit softkeys to enter the code in the four-digit code field of the Transponder Status Box. When the last digit is entered, the transponder code becomes active.

When entering a code, press the **BKSP** Softkey as needed to back up and change code digits.

Enter Code Using the FMS Knob

- 1) Press the **XPDR** Softkey to display the transponder Mode Selection softkeys.
- 2) Press the **CODE** Softkey to display the transponder Code Selection softkeys, which includes the digit softkeys.
- 3) Turn the small **FMS** Knob to enter the first two digits.
- 4) Turn the large **FMS** Knob to place the cursor in position to change the second two digits.
- 5) Turn the small **FMS** Knob to enter the second two digits.
- 6) Press the **ENT** Key to activate the code immediately, or wait 10 seconds and the code will become active.



Blank Page

SECTION 5: AUDIO PANEL

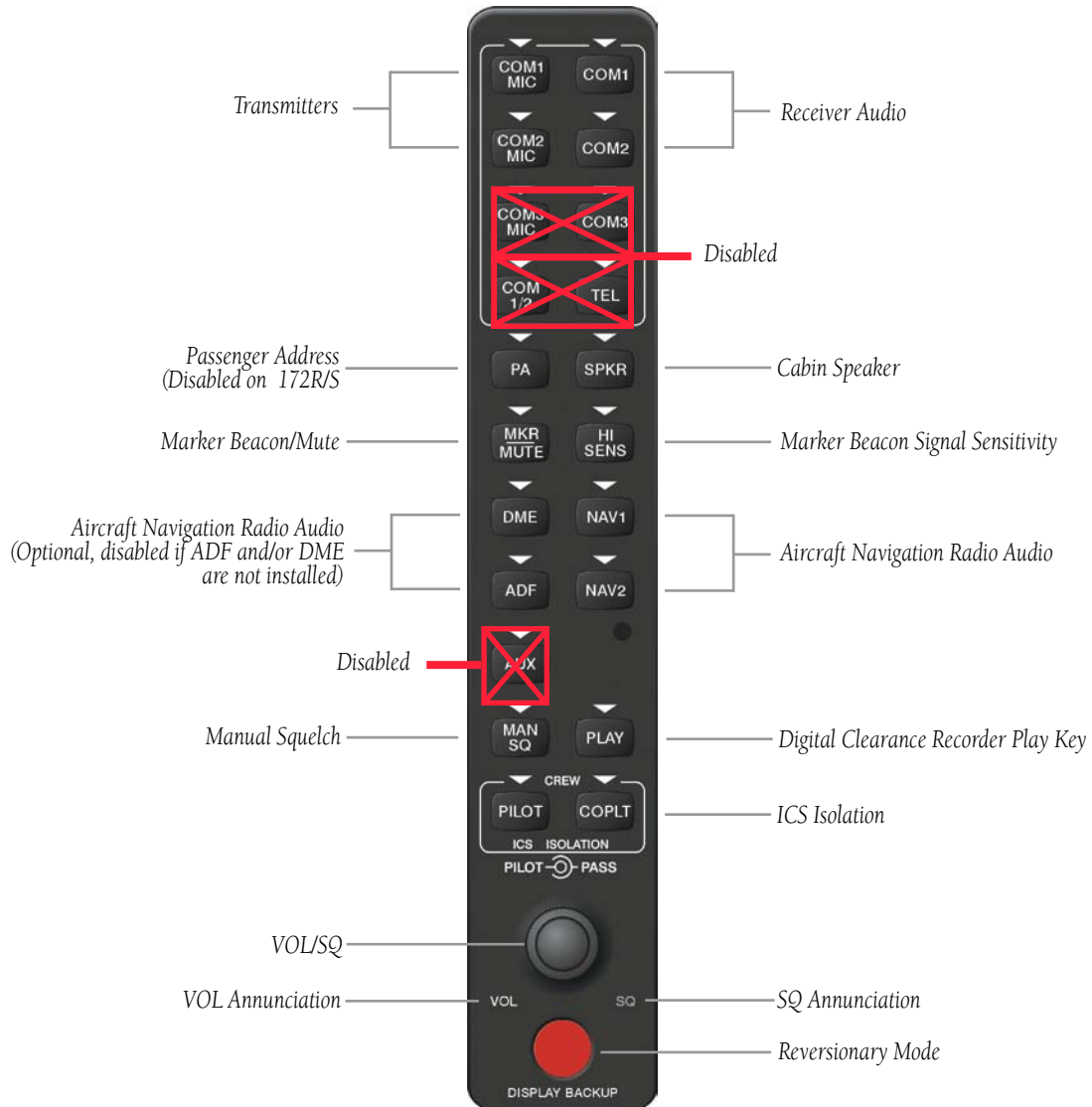

Figure 5-1 Front Panel Controls

5.1 COM RADIO SELECTION

Pressing the **COM1 MIC** or **COM2 MIC** Key selects the active transmitter (i.e., microphone). The associated receiver audio (**COM1** or **COM2**) also becomes selected when the COM MIC Key is pressed.

To prevent deselecting the desired received audio when pressing another COM MIC Key, press the already selected **COM1** or **COM2** Key before pressing the other COM MIC Key.



Figure 5-2 Transceivers

5.2 CABIN SPEAKER

Pressing the **SPKR** Key selects and deselects the cabin speaker. All of the radios can be heard over the cabin speaker. Speaker audio is muted when the PTT is pressed. Certain aural alerts and warnings (autopilot, traffic, altitude) are always heard on the speaker, even when the speaker is not selected.

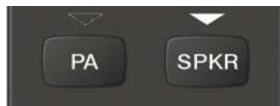

Figure 5-3 Passenger Address and Speaker Keys

5.3 PASSENGER ADDRESS (PA) SYSTEM (T)182T AND (T)206H ONLY

A passenger address system is available for delivering voice messages over the cabin speaker. When the **PA** Key is selected on the Audio Panel, the COM MIC Annunciator is extinguished, and the active COM frequency changes to white, indicating that there is no COM selected. A Push-to-

Talk (PTT) must be pressed to deliver PA announcements. The PA Annunciator flashes about once per second while the PTT is depressed.

5.4 MARKER BEACON RECEIVER

The marker beacon receiver is always on. Only the marker beacon audio can be turned off. Figure 5-4 shows the marker beacon annunciators on the PFD.

When the **MKR/MUTE** Key is pressed, the key annunciator is lit and the audio tone can be heard over the speaker or headsets during marker beacon reception.

When the tone is active, pressing the **MKR/MUTE** Key once mutes the audio but does not affect the marker annunciator. The audio returns when the next marker signal is received.

To turn off the marker beacon audio, press the **MKR/MUTE** Key once when there is no marker indication present, or press twice when an indication is present. The key annunciator extinguishes when the marker beacon audio is turned off.

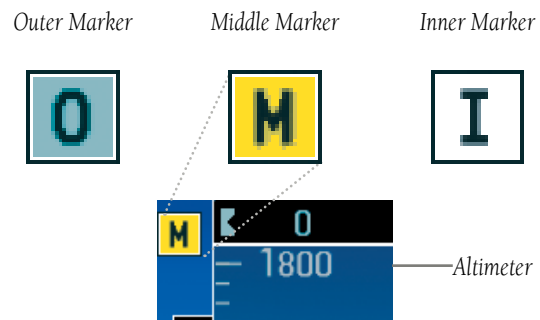

Figure 5-4 Marker Beacon Annunciators on the PFD

Marker Beacon Signal Sensitivity

The **HI SENS** Key can be pressed for increased marker beacon signal sensitivity.



Figure 5-5 Marker Beacon

5.5 NAV RADIO AUDIO SELECTION

Pressing **DME**, **ADF**, **NAV1**, or **NAV2** selects and deselects the audio source and activates the annunciator. Selected audio can be heard over the headset and the speakers. These four keys can be selected individually or together.



Figure 5-6 Navigation Radios

5.6 INTERCOM SYSTEM (ICS) ISOLATION

Press the **PILOT** and/or **COPLT** Key to select who is isolated from hearing the Nav/Com radios and music. Selection scenarios are addressed in Table 5-1.



Figure 5-7 ICS Isolation

PILOT KEY Annunciator	COPLT KEY Annunciator	Pilot Hears	Copilot Hears	Passenger Hears
OFF	OFF	Selected radios, aural alerts, pilot, copilot, passengers, music	Selected radios, aural alerts, pilot, copilot, passengers, music	Selected radios, aural alerts, pilot, copilot, passengers, music
ON	OFF	Selected radios, aural alerts, pilot	Copilot, passengers, music	Copilot, passengers, music
OFF	ON	Selected radios, aural alerts, pilot, passengers, music	Copilot	Selected radios, aural alerts, pilot, passengers, music
ON	ON	Selected radios, aural alerts, pilot, copilot	Selected radios, aural alerts, pilot, copilot	Passengers, music

Table 5-1 ICS Isolation Modes

5.7 INTERCOM SQUELCH CONTROL

Select manual squelch for intercom audio by pressing the **MAN SQ** Key to light the annunciator.

Pressing the small **VOL/SQ** Knob now switches between volume and squelch adjustment by lighting **VOL** or **SQ** respectively.



Figure 5-8 Volume/Squelch Control

5.8 DIGITAL CLEARANCE RECORDER AND PLAYER

Each reception of primary active COM audio is automatically recorded in a memory block. When the next transmission is received, it is recorded in the next memory block, and so on. Once the 2.5 minutes of recording time has been reached, the recorder begins recording over the stored memory blocks, starting from the oldest block. Powering off the unit automatically clears all recorded blocks.



Figure 5-9 Clearance Recorder Play Key

- Pressing the **PLAY** Key once plays the latest recorded memory block, then returns to normal operation.
- Pressing the **MKR/MUTE** Key while playing a memory block stops play.
- Pressing the **PLAY** Key during play begins playing the previously recorded memory block. Each subsequent press of the **PLAY** Key begins playing the next previously recorded block.

If a COM input signal is detected while playing, play is halted and the new COM input signal is recorded as the latest block.

SECTION 6: AUTOMATIC FLIGHT CONTROL



NOTE: The Aircraft Flight Manual (AFM) always supersedes the information in this guide. This section only applies to the GFC 700 Automatic Flight Control System (AFCS).

6.1 AFCS CONTROLS

The following dedicated AFCS keys are located on the bezels of the PFD and MFD:



Figure 6-1 Dedicated AFCS Controls

The following AFCS controls are located in the cockpit separately from the MFD:

- **AP DISC Switch (Autopilot Disconnect)**

Disengages the autopilot and interrupts pitch trim operation. The red **AP DISC** Switch is located forward of the **MET** Switch on the pilot's control wheel left grip. This switch may be used to

acknowledge an autopilot disconnect and mute the associated aural tone.

- **CWS Button (Control Wheel Steering)**

Momentarily disengages the autopilot and synchronizes the flight director's Command Bars with the current aircraft pitch (if not in Glideslope Mode) and roll (if in Roll Hold Mode). The **CWS** Button is located on the top of the pilot's control wheel right grip. Upon release of the **CWS** Button, the flight director may establish new reference points, depending on the current pitch and roll modes.

- **GA Switch (Go-Around)**

Disengages the autopilot, selects flight director Go-Around Mode, and activates the missed approach. The **GA** Switch is located on the instrument panel above the throttle.

- **MET Switch (Manual Electric Trim)**

The **MET** Switch is located on the pilot's control wheel left grip. This composite switch is split into left and right sides. The left switch is the ARM contact and the right switch controls the DN (forward) and UP (rearward) contacts. The **MET** ARM switch can be used to disengage the autopilot and to acknowledge an autopilot disconnect alert and mute the associated aural tone. Manual trim commands are generated only when both sides of the switch are operated simultaneously. If either side of the switch is active separately for more than three seconds, MET function is disabled and 'PTRM' is displayed as the AFCS Status Annunciation on the PFD. The function remains disabled until both sides of the switch are inactivated.

6.2 FLIGHT DIRECTOR OPERATION

With the flight director activated, the aircraft can be hand-flown to follow the path shown by the Command Bars. Maximum commanded pitch (+20°/-15°) and bank (22°) angles, vertical acceleration, and roll rate are limited to values established during AFCS certification. The flight director also provides commands to the autopilot.

Activating the Flight Director

Pressing the **FD** or **AP** Key (when the flight director is not active) activates the flight director in default pitch/roll modes. Pushing the **GA** Switch or any flight director mode key activates the flight director in the respective mode(s).

The flight director may be turned off by pressing the **FD** Key.

Command Bars

Upon activation of the flight director, Command Bars are displayed on the PFD as a single cue. If the attitude information sent to the flight director becomes invalid or unavailable, the Command Bars are removed from the display. The Command Bars do not override the aircraft symbol.

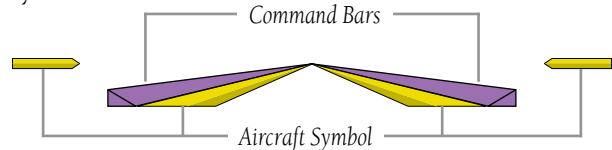

Figure 6-2 Command Bars



Figure 6-3 PFD AFCS Display

AFCS Status Box

Flight director roll modes are shown on the left and pitch on the right. Armed modes are annunciated in white and active in green. Autopilot status is displayed in the center of the AFCS Status Box.

6.3 FLIGHT DIRECTOR MODES

Flight director modes are normally selected independently for the pitch and roll axes. Unless otherwise specified, all mode keys are alternate action (i.e., press on, press off). In the absence of specific mode selection, the flight director reverts to the default pitch and/or roll mode(s).

Armed modes are annunciated in white and active in green in the AFCS Status Box. Under normal operation, when the control for the active flight director mode is pressed, the flight director reverts to the default mode(s) for the axis(es). Automatic transition from armed to active mode is indicated by the white armed mode annunciation moving to the green active mode field and flashing for ten seconds.

A flashing yellow mode annunciation and annunciator light indicate loss of sensor (AHRS, ADC, IAU) or navigation data (VOR, LOC, GPS, VNAV, SBAS) required to compute commands. When such a loss occurs, the system automatically begins to roll the wings level or maintain the pitch angle, depending on the affected axis. The flashing annunciation stops when the affected mode key is pressed or another mode for the axis is selected. If after ten seconds no action is taken, the flashing annunciation stops and the flight director enters the default mode for the affected axis.



Figure 6-4 Loss of VOR Signal

If the information required to compute a flight director mode becomes invalid or unavailable, the flight director automatically reverts to the default mode for that axis. The flight director is automatically disabled if the attitude information required to compute the default flight director modes becomes invalid or unavailable.

Pitch Modes

- **Pitch Hold** (default mode)— Holds the current aircraft pitch attitude; may be used to climb/descend to the Selected Altitude
- **Selected Altitude Capture** — Captures the Selected Altitude
- **Altitude Hold** — Holds the current Altitude Reference
- **Vertical Speed** — Maintains the current aircraft vertical speed; may be used to climb/descend to the Selected Altitude
- **Flight Level Change** — Maintains the current aircraft airspeed while the aircraft is climbing/descending to the Selected Altitude
- **Vertical Path Tracking** — Follows an active vertical profile for enroute and terminal phases of flight
- **VNAV Target Altitude Capture** — Captures the VNAV Target Altitude
- **Glidepath** — Intercepts and tracks the SBAS glidepath on approach (only available in installations with GIA 63W Integrated Avionics Units and when SBAS is available)
- **Glideslope** — Intercepts and tracks the ILS glideslope on approach
- **Go Around** — Automatically disengages the autopilot and commands a constant pitch angle and wings level while in the air

Table 6-1 lists the pitch modes with their corresponding controls and annunciations. The mode reference (shown with default measurement units) is displayed next to the active mode annunciation for Altitude Hold, Vertical Speed, and Flight Level Change modes. The **NOSE UP/NOSE DN** Keys can be used to change the pitch mode reference while operating under Pitch Hold, Vertical Speed, or Flight Level Change Mode.

Pitch Mode	Control	Annunciation	Reference Range	Reference Change Increment
Pitch Hold	(default)	PIT	-20° to +15°	0.5°
Selected Altitude Capture	*	ALTS		
Altitude Hold	ALT Key	ALT nnnnn FT		
Vertical Speed	VS Key	VS nnnn FPM	-3000 to +1500 fpm	100 fpm
Flight Level Change, IAS Hold	FLC Key	FLC nnn KT	70 to 165 kt	1 kt
Vertical Path Tracking	VNV Key	VPTH		
VNAV Target Altitude Capture	**	ALTV		
Glidepath	APR Key	GP		
Glideslope		GS		
Go Around (in air)	GA Switch	GA		

* *ALTS is armed automatically when PIT, VS, FLC, or GA is active, and under VPTH when the Selected Altitude is to be captured instead of the VNAV Target Altitude.*

** *ALTV is armed automatically under VPTH when the VNAV Target Altitude is to be captured instead of the Selected Altitude.*

Table 6-1 Flight Director Pitch Modes

Pitch Hold Mode (PIT)

When the flight director is activated (the **FD** Key is pressed), Pitch Hold Mode is selected by default. Pitch Hold Mode is indicated as the active pitch mode by the green annunciation ‘PIT’. This mode may be used for climb or descent to the Selected Altitude (shown above the Altimeter), since Selected Altitude Capture Mode is automatically armed when the mode is activated.

In Pitch Hold Mode, the flight director maintains a constant pitch attitude, the pitch reference. The pitch reference is set to the aircraft attitude at the moment of mode selection. If the aircraft pitch attitude exceeds the flight director pitch command limitations, the flight director commands a pitch angle equal to the nose-up/down limit.

Changing the Pitch Reference

When operating in Pitch Hold Mode, the pitch reference can be adjusted by:

- Using the **NOSE UP/NOSE DN** Keys
- Pressing the **CWS** Button, hand-flying the aircraft to establish a new pitch reference, then releasing the **CWS** Button

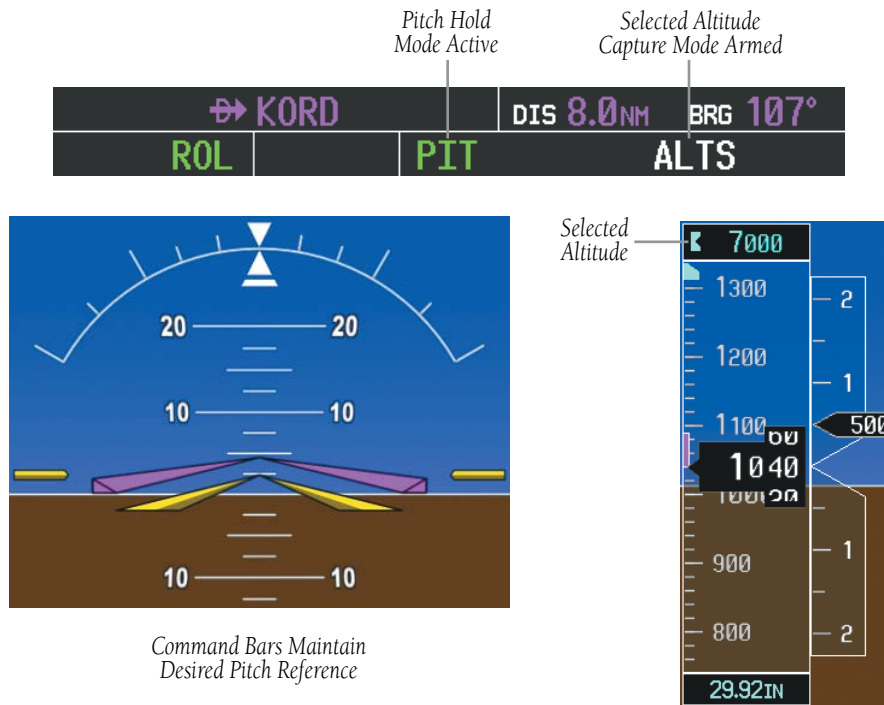

Figure 6-5 Pitch Hold Mode

Selected Altitude Capture Mode (ALTS)

Selected Altitude Capture Mode arms automatically when the flight director is in Pitch Hold, Vertical Speed, Flight Level Change, or Go Around Mode. This mode is also armed automatically under Vertical Path Tracking Mode when the Selected Altitude is to be captured instead of the VNAV Target Altitude. The white 'ALTS' annunciation indicates Selected Altitude Capture Mode is armed (see Figure 6-5 for example).

The **ALT** Knob is used to set the Selected Altitude, shown above the Altimeter.

As the aircraft nears the Selected Altitude, the flight director automatically transitions to Selected Altitude Capture Mode with Altitude Hold Mode armed (Figure 6-7). This automatic transition is indicated by the green 'ALTS' annunciation flashing for up to ten seconds and the appearance of the white 'ALT' annunciation. The Selected Altitude is shown as the Altitude Reference beside the 'ALTS' annunciation.

At 50 ft from the Selected Altitude, the flight director automatically transitions from Selected Altitude Capture to Altitude Hold Mode and holds the Selected Altitude (shown as the Altitude Reference). As Altitude Hold Mode becomes active, the white 'ALT' annunciation moves to the active pitch mode field and flashes green for ten seconds to indicate the automatic transition.

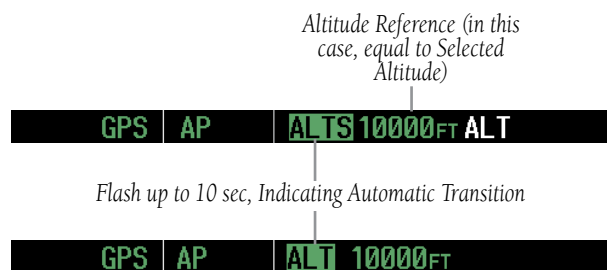

Figure 6-6 Automatic Mode Transitions During Altitude Capture

Changing the Selected Altitude



NOTE: Pressing the **CWS** Button while in Selected Altitude Capture Mode does not cancel the mode.

Use of the **ALT** Knob to change the Selected Altitude while Selected Altitude Capture Mode is active causes the flight director to revert to Pitch Hold Mode with Selected Altitude Capture Mode armed for the new Selected Altitude.

Altitude Hold Mode (ALT)

Altitude Hold Mode can be activated by pressing the **ALT** Key; the flight director maintains the current aircraft altitude (to the nearest ten feet) as the Altitude Reference. The flight director's Altitude Reference is shown in the AFCS Status Box and is independent of the Selected Altitude, displayed above the Altimeter. Altitude Hold Mode active is indicated by a green 'ALT' annunciation in the AFCS Status Box.

Altitude Hold Mode is automatically armed when the flight director is in Selected Altitude Capture Mode. Selected Altitude Capture Mode automatically transitions to Altitude Hold Mode when the altitude error is less than 50 ft. In this case, the Selected Altitude becomes the flight director's Altitude Reference.

Changing the Altitude Reference



NOTE: Turning the **ALT** Knob while in Altitude Hold Mode changes the Selected Altitude, but not the flight director's Altitude Reference and does not cancel the mode.

With the **CWS** Button depressed, the aircraft can be hand-flown to a new Altitude Reference. When the **CWS** Button is released at the desired altitude, the new altitude is established as the Altitude Reference.

If the Selected Altitude is reached during CWS maneuvering, the Altitude Reference is not changed. To adjust the Altitude Reference in this case, the **CWS** Button must be pressed again after the Selected Altitude is reached.

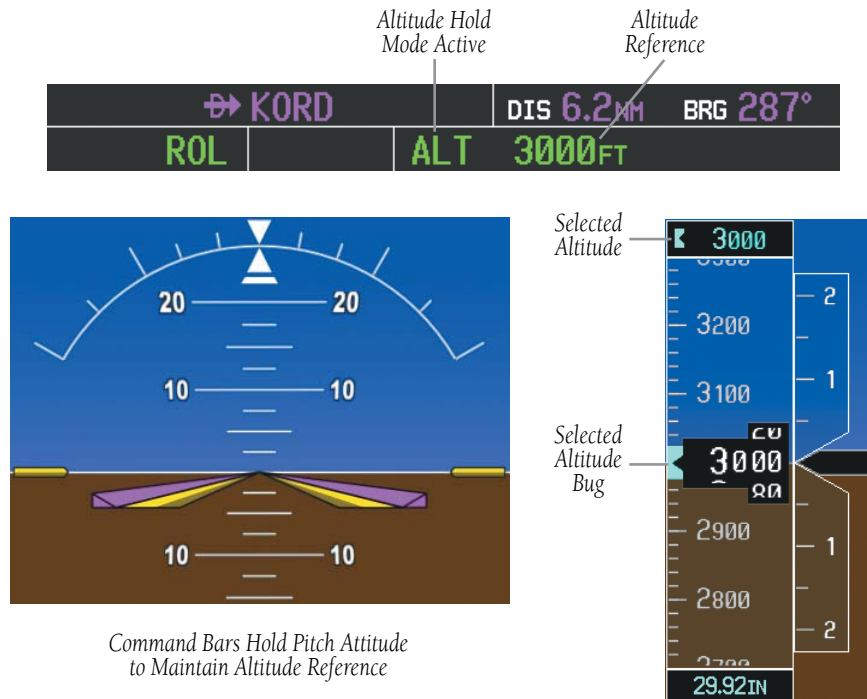

Figure 6-7 Altitude Hold Mode

Vertical Speed Mode (VS)

In Vertical Speed Mode, the flight director acquires and maintains a Vertical Speed Reference. Current aircraft vertical speed (to the nearest 100 fpm) becomes the Vertical Speed Reference at the moment of Vertical Speed Mode activation. Vertical Speed Mode does not consider the relative position of the Selected Altitude in relation to the current aircraft altitude at the time of mode activation, so it is possible to use Vertical Speed Mode while not climbing/descending to the Selected Altitude.

Vertical Speed Mode is activated by pressing the **VS** Key; the 'VS' annunciation appears in the AFCS Status Box to indicate the active pitch mode, along with the Vertical Speed Reference to the right. The Vertical Speed Reference is also displayed above the Vertical Speed Indicator. A Vertical Speed Reference Bug corresponding to the Vertical Speed Reference is shown on the indicator.

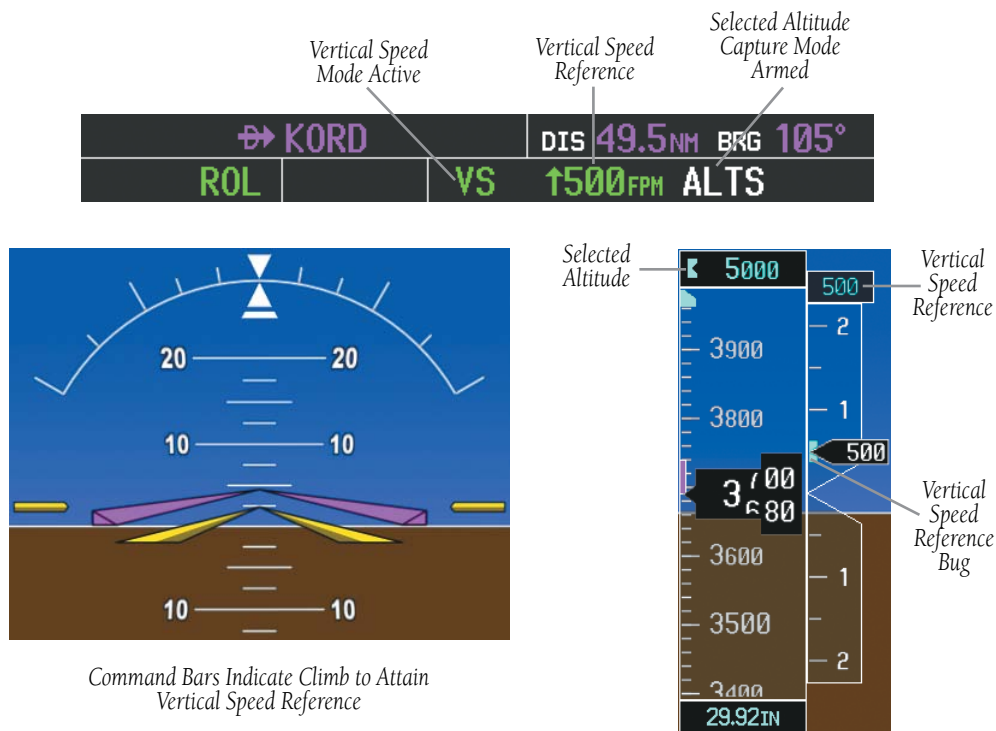

Figure 6-8 Vertical Speed Mode

Changing the Vertical Speed Reference

The Vertical Speed Reference (shown both in the AFCS Status Box and above/below the Vertical Speed Indicator) may be changed by:

- Using the **NOSE UP/NOSE DN** Keys
- By pressing the **CWS** Button, hand-flying the aircraft to attain a new Vertical Speed Reference, then releasing the **CWS** Button

Flight Level Change Mode (FLC)



NOTE: The Selected Altitude should be set before selecting Flight Level Change Mode.

Flight Level Change Mode is selected by pressing the **FLC** Key. When Flight Level Change Mode is active, the flight director continuously monitors Selected Altitude, airspeed, and altitude. This mode acquires and maintains the Airspeed Reference while climbing or descending to the Selected Altitude (shown above the Altimeter). The Airspeed Reference is set to the current airspeed upon mode activation. Flight Level Change Mode is indicated by an 'FLC' annunciation beside the Airspeed Reference in the AFCS Status Box. The Airspeed Reference is also displayed directly above the Airspeed Indicator, along with a bug corresponding to the Airspeed Reference along the tape.

Engine power must be adjusted to allow the autopilot to fly the aircraft at a pitch attitude corresponding to the

Airspeed Reference and the desired flight profile (climb or descent). The flight director maintains the current altitude until either engine power or the Airspeed Reference are adjusted and does not allow the aircraft to climb or descend away from the Selected Altitude.

Changing the Airspeed Reference

The Airspeed Reference (shown in both the AFCS Status Box and above the Airspeed Indicator) may be adjusted:

- Using the **NOSE UP/NOSE DN** Keys
- By pressing the **CWS** Button, hand-flying the aircraft to a new airspeed, then releasing the **CWS** Button to establish the new Airspeed Reference

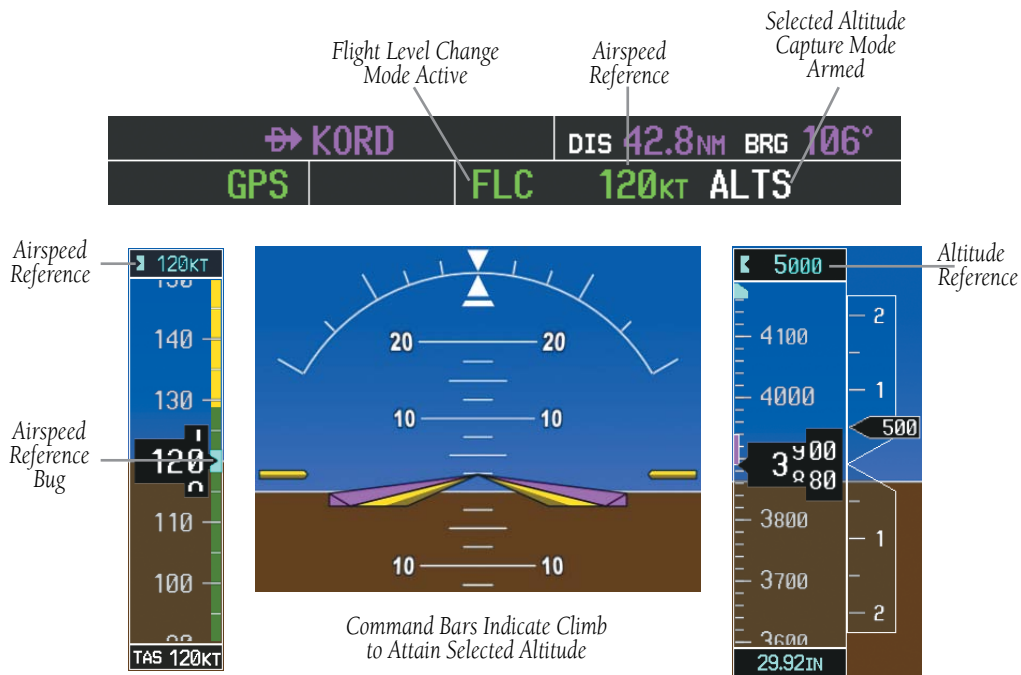

Figure 6-9 Flight Level Change Mode

Vertical Navigation Modes (VPTH, ALTV)



NOTE: Pressing the **CWS** Button while Vertical Path Tracking Mode is active does not cancel the mode. The autopilot guides the aircraft back to the descent path upon release of the **CWS** Button.



NOTE: VNAV flight director pitch modes are available only in conjunction with GPS roll modes.



NOTE: The Selected Altitude takes precedence over any other vertical constraints.

Vertical Navigation (VNAV) flight control is available for enroute/terminal cruise and descent operations when VNAV has been enabled and a VNAV flight plan (with at least one vertical waypoint) or direct-to with a vertical constraint has been activated. Refer to the Navigation section for more information on VNAV flight plans. The flight director may be armed for VNAV at any time, but no target altitudes are captured during a climb.

The Command Bars provide vertical profile guidance based on specified altitudes (entered manually or loaded from the database) at waypoints in the active flight plan or vertical direct-to. The appropriate VNAV flight control modes are sequenced by the flight director to follow the path defined by the vertical profile. Upon reaching the last waypoint in the VNAV flight plan, the flight director transitions to Altitude Hold Mode and cancels any armed VNAV modes.

Vertical Path Tracking Mode (VPTH)



NOTE: If another pitch mode key is pressed while Vertical Path Tracking Mode is selected, Vertical Path Tracking Mode reverts to armed.

When a vertical profile (VNAV flight plan) is active and the **VNV** Key is pressed, Vertical Path Tracking Mode is armed in preparation for descent path capture. 'VPTH' (or 'V' when Glidepath or Glideslope Mode is concurrently armed) is annunciated in white in addition to previously armed modes. If applicable, the appropriate altitude capture mode is armed for capture of the next VNAV Target Altitude (ALTV) or the Selected Altitude (ALTS), whichever is greater.



Figure 6-10 Vertical Path Tracking Armed Annunciations

Prior to descent path interception, the Selected Altitude must be set below the current aircraft altitude by at least 75 ft. For the flight director to transition from Altitude Hold to Vertical Path Tracking Mode, acknowledgment is required within five minutes of descent path capture by:

- Pressing the **VNV** Key
- Adjusting the Selected Altitude

If acknowledgment is not received within one minute of descent path interception, the white 'VPTH' annunciation and the **VNV** Key annunciator light start to flash. Flashing continues until acknowledged or the descent path is intercepted. If the descent is not confirmed by the time of interception, Vertical Path Tracking Mode remains armed and the descent is not captured.

In conjunction with the “TOD [top of descent] within 1 minute” annunciation in the Navigation Data Box, VNAV indications (VNAV Target Altitude, vertical deviation, and vertical speed required) appears on the PFD in magenta (Figure 6-11).

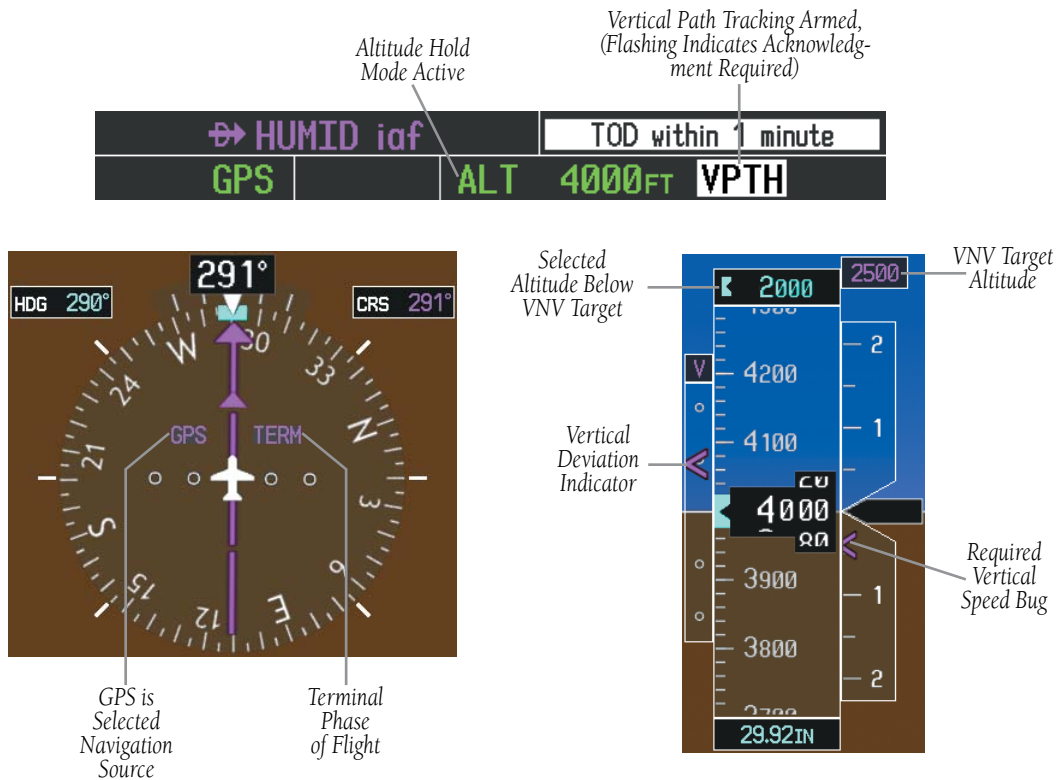

Figure 6-11 Vertical Path Capture

When a descent leg is captured (Figure 6-12), Vertical Path Tracking becomes active and tracks the descent profile. An altitude capture mode ('ALTS' or 'ALTV') is armed as appropriate.

- Cannot be computed for a leg type (such as a hold or procedure turn)

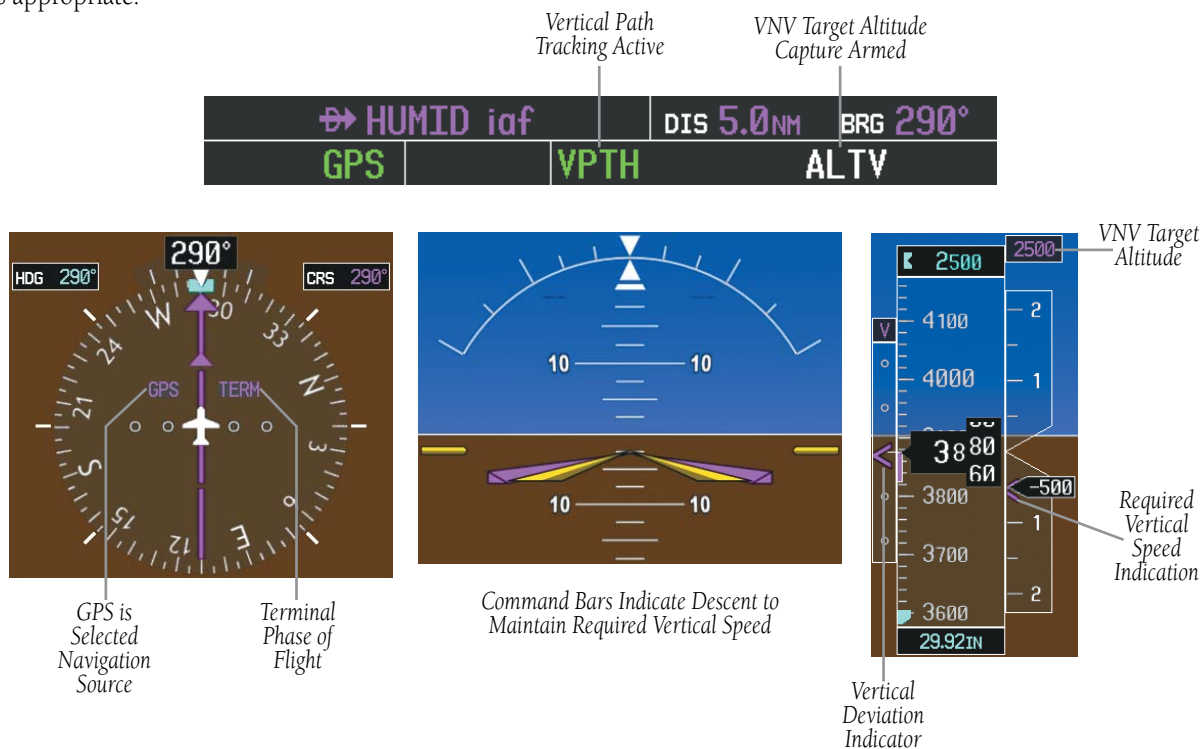

Figure 6-12 Vertical Path Tracking Mode

Automatic Pitch Hold Reversion

Several situations can occur while Vertical Path Tracking Mode is active which cause the flight director to revert to Pitch Hold Mode. Vertical Path Tracking and the appropriate altitude capture modes are armed for possible descent profile recapture if the vertical deviation:

- Exceeds 200 ft during an overspeed condition
- Experiences a discontinuity exceeding 200 ft due to a flight plan change
- Becomes invalid due to excessive cross-track error, track angle error

The following circumstances cause mode reversion without arming Vertical Path Tracking Mode:

- Navigation source manually changed from GPS
- **CNCL VNV** Softkey selected on the Active Flight Plan Page (MFD)
- All remaining vertical waypoints deleted from the flight plan
- Displays entering Reversionary Mode

Non-Path Descents

Pitch Hold, Vertical Speed, and Flight Level Change modes can also be used to fly non-path descents while VNAV flight control is selected. If the **VS** or **FLC** Key is pressed while Vertical Path Tracking Mode is selected, Vertical Path Tracking Mode reverts to armed along with the appropriate altitude capture mode to allow profile re-capture.

GPS | **FLC** | **120KT** | **ALTS** | **VPTH**

Figure 6-13 Flight Level Change VNV Non-Path Descent

To prevent immediate profile re-capture, the following must be satisfied:

- At least ten seconds have passed since the non-path transition was initiated
- Vertical deviation from the profile has exceeded 250 ft, but is now less than 200 ft

Pressing the **VNV** Key twice re-arms Vertical Path Tracking for immediate profile re-capture.

VNAV Target Altitude Capture Mode (ALTV)



NOTE: Armed VNAV Target Altitude and Selected Altitude capture modes are mutually exclusive. However, Selected Altitude Capture Mode is armed implicitly (not annunciated) whenever VNAV Target Altitude Capture Mode is armed. This ensures the Selected Altitude is not violated during a change from VNAV Target Altitude Capture to Selected Altitude Capture Mode close to Selected Altitude interception.

VNAV Target Altitude Capture is analogous to Selected Altitude Capture Mode and is armed automatically after the **VNV** Key is pressed and the next VNAV Target Altitude is to be intercepted before the Selected Altitude. The annunciation 'ALTV' indicates that the VNAV Target Altitude is to be captured. VNAV Target Altitudes are shown in the active flight plan or vertical direct-to, and can be entered manually

or loaded from a database (see the Navigation section for details). At the same time as "TOD within 1 minute" is annunciated in the Navigation Data Box, the VNAV Target Altitude is displayed above the Vertical Speed Indicator (see Figure 6-12). VNAV Target Altitudes can be modified until VNAV Target Altitude Capture Mode becomes active.

As the aircraft nears the VNAV Target Altitude, the flight director automatically transitions to VNAV Target Altitude Capture Mode with Altitude Hold Mode armed. This automatic transition is indicated by the green 'ALTV' annunciation flashing for up to ten seconds and the appearance of the white 'ALT' annunciation. The VNAV Target Altitude is shown as the Altitude Reference beside the 'ALTV' annunciation.

At 50 ft from the VNAV Target Altitude, the flight director automatically transitions from VNAV Target Altitude Capture to Altitude Hold Mode and tracks the level leg. As Altitude Hold Mode becomes active, the white 'ALT' annunciation moves to the active pitch mode field and flashes green for ten seconds to indicate the automatic transition. The flight director automatically arms Vertical Path Tracking, allowing upcoming descent legs to be captured and subsequently tracked.

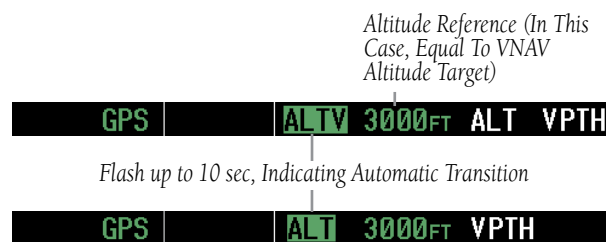

Figure 6-14 VNAV Altitude Capture

Changing the VNAV Target Altitude



NOTE: Pressing the **CWS** Button while in VNAV Target Altitude Capture Mode does not cancel the mode.

Changing the current VNAV Target Altitude while VNAV Target Altitude Capture Mode is active causes the flight director to revert to Pitch Hold Mode. Vertical Path Tracking and the appropriate altitude capture mode are armed in preparation to capture the new VNAV Target Altitude or the Selected Altitude, depending on which altitude is to be intercepted first.

VNAV target altitudes can be changed while editing the active flight plan (see the Navigation section for details).

Glidepath Mode (GP)



NOTE: Pressing the **CWS** Button while Glidepath Mode is active does not cancel the mode. The autopilot guides the aircraft back to the glidepath upon release of the **CWS** Button.



NOTE: *Glidepath Mode is available only in installations with GIA 63W Integrated Avionics Units and SBAS currently available.*

Glidepath mode is used to track the SBAS-based glidepath. Arming Glidepath Mode (annunciated in white as ‘GP’) requires:

- Approach supporting SBAS vertical guidance is loaded into the flight plan
- Expected availability of vertical guidance
- GPS Approach Mode is armed, after acquiring clearance for approach, prior to intercepting the SBAS glidepath (GPS is the selected navigation source and the **APR** Key is pressed; see GPS Approach Mode)

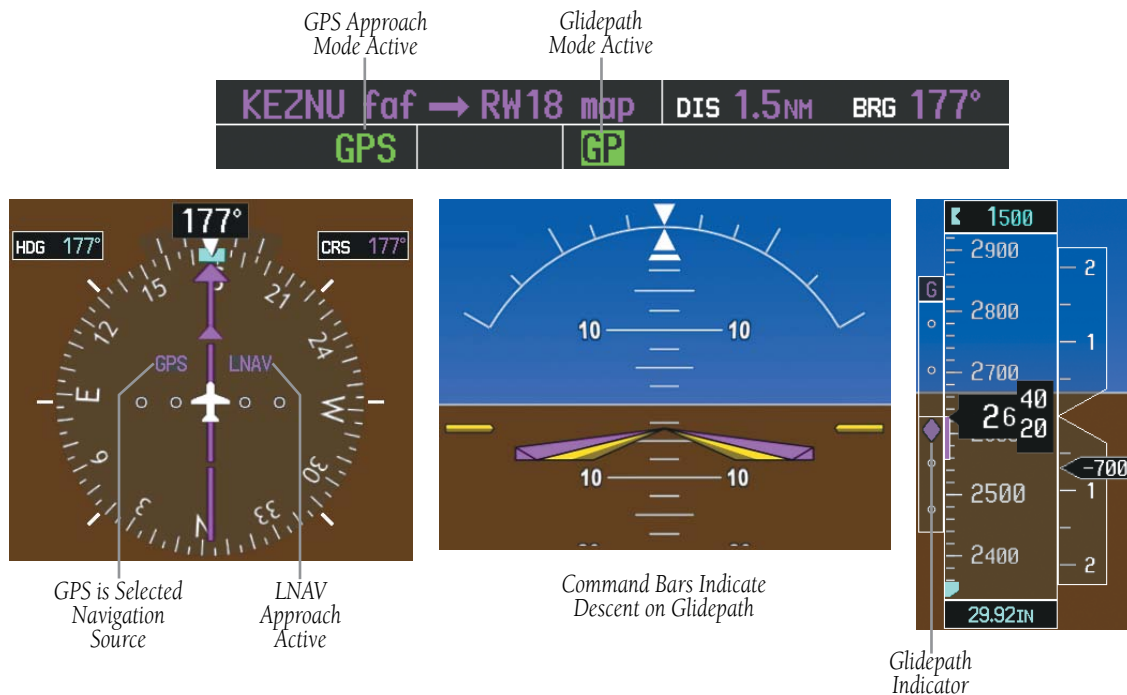

Figure 6-15 Glidepath Mode

GPS | AP | VPTH | ALTS GP

Figure 6-16 Glidepath Mode Armed

If vertical guidance becomes or is expected to become unavailable and the approach downgrades, Glidepath Mode is disarmed. When vertical guidance becomes available again, Glidepath Mode is automatically re-armed under GPS Approach Mode.

Glide Slope Mode (GS)



NOTE: Pressing the **CWS** Button while **Glide Slope Mode** is active does not cancel the mode. The autopilot guides the aircraft back to the glideslope upon release of the **CWS** Button.

Glide Slope Mode is available for LOC/ILS approaches to capture and track the glideslope. Glide Slope Mode is armed when:

- A valid localizer frequency is tuned
- LOC Approach Mode is armed (the **APR** Key is pressed and either LOC is the selected navigation source or a LOC/ILS approach is loaded into the flight plan; see LOC Approach Mode)

LOC | HDG | AP | ALT 10000FT | GS

Figure 6-18 Glide Slope Mode Armed

Once the localizer has been set as the navigation source, the localizer and glideslope can be captured. Upon reaching the glideslope, the flight director transitions to Glide Slope Mode and begins to intercept and track the glideslope.

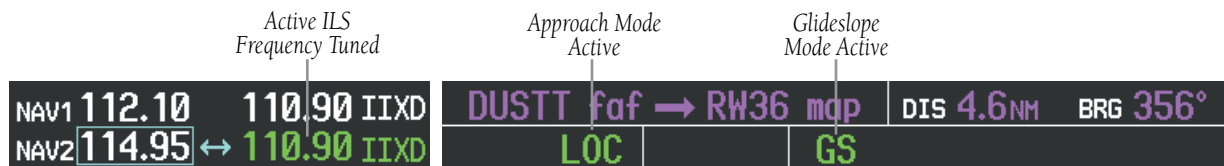

NAV2 (localizer) is Selected Navigation Source

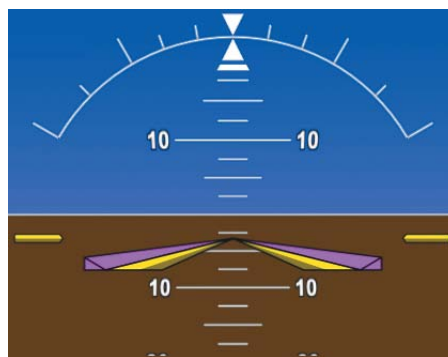

Command Bars Indicate Descent on Localizer/Glideslope Path

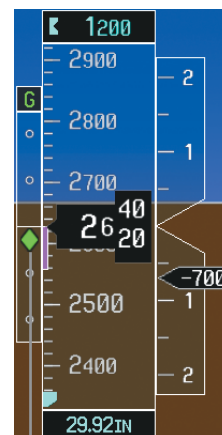

Glideslope Indicator

Figure 6-17 Glide Slope Mode

Go Around (GA) Mode

Pushing the **GA** Switch engages the flight director in a wings level, 7° pitch-up attitude, allowing the execution of a missed approach or a go around. This mode is a coupled pitch and roll mode and is annunciated as 'GA' in both the pitch and roll active mode fields. Go Around Mode disengages the autopilot and arms Altitude Hold Mode automatically. Subsequent autopilot engagement is allowed. Attempts to modify the aircraft attitude (i.e., with the **CWS** Button or **NOSE UP/NOSE DN** keys) result in reversion to Pitch and Roll Hold modes.

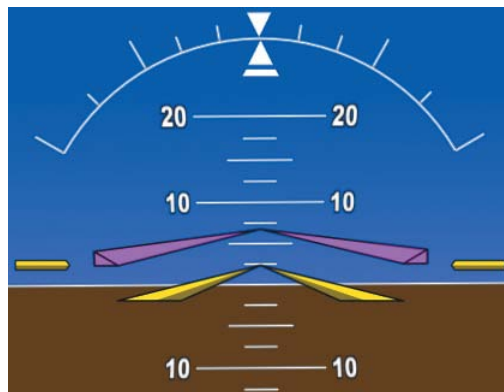
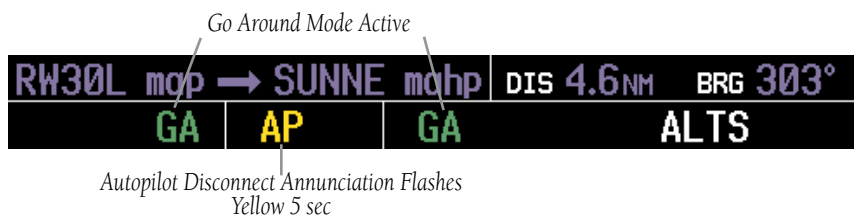

Command Bars Indicate Climb

Figure 6-19 Go Around Mode

Roll Modes

- **Roll Hold** (default mode) — Holds the current aircraft roll attitude or rolls the wings level, depending on the commanded bank angle
- **Heading Select** — Captures and tracks the Selected Heading
- **Navigation** (GPS, VOR, LOC) — Captures and tracks the selected navigation source
- **Backcourse** — Captures and tracks a localizer signal for backcourse approaches
- **Approach** (GPS, VAPP, LOC) — Captures and tracks the selected navigation source with greater sensitivity for approach
- **Go Around** — Commands a constant pitch angle and wings level while in the air

The following table relates each roll mode to its respective control and annunciation. Refer to the pitch modes section for information regarding Go Around and Takeoff Modes.

Roll Mode	Control	Annunciation
Roll Hold	(default)	ROL
Heading Select	HDG Key	HDG
Navigation, GPS Arm/Capture/Track	NAV Key	GPS
Navigation, VOR Enroute Arm/Capture/Track		VOR
Navigation, LOC Arm/Capture/Track (No Glideslope)		LOC
Backcourse Arm/Capture/Track	BC Key	BC
Approach, GPS Arm/Capture/Track	APR Key	GPS
Approach, VOR Arm/Capture/Track		VAPP
Approach, ILS Arm/Capture/Track (Glideslope Mode automatically armed)		LOC
Go Around (in air)	GA Switch	GA

Table 6-2 Roll Modes

The **CWS** Button does not change lateral references for Heading Select, Navigation, Backcourse, or Approach modes. The autopilot guides the aircraft back to the Selected Heading/Course upon release of the **CWS** Button.

Roll Hold Mode (ROL)



NOTE: If Roll Hold Mode is activated as a result of a mode reversion, the flight director rolls the wings level.

When the flight director is activated (the **FD** or **AP** Key is pressed), Roll Hold Mode is selected by default. This mode is annunciated as 'ROL in the AFCS Status Box. The current aircraft bank angle is held, subject to the bank angle conditions listed in Table 6-3.



Figure 6-20 Roll Hold Mode Annunciation

Bank Angle	Flight Director Response
< 6°	Rolls wings level
6° to 22°	Maintains current aircraft roll attitude
> 22°	Limits bank to 22°

Table 6-3 Roll Hold Mode Responses

Changing the Roll Reference

The roll reference can be changed by pressing the **CWS** Button, establishing the desired bank angle, then releasing the **CWS** Button.

Heading Select Mode (HDG)

Heading Select Mode is activated by pressing **HDG** Key. Heading Select Mode acquires and maintains the Selected Heading. The Selected Heading is shown by a light blue bug on the HSI and in the box to the upper left of the HSI.

Changing the Selected Heading



NOTE: Pressing the **HDG** Knob synchronizes the Selected Heading to the current heading.

The Selected Heading is adjusted using the **HDG** Knob on either display. Pressing the **CWS** Button and hand-flying the aircraft does not change the Selected Heading. The autopilot guides the aircraft back to the Selected Heading upon release of the **CWS** Button.

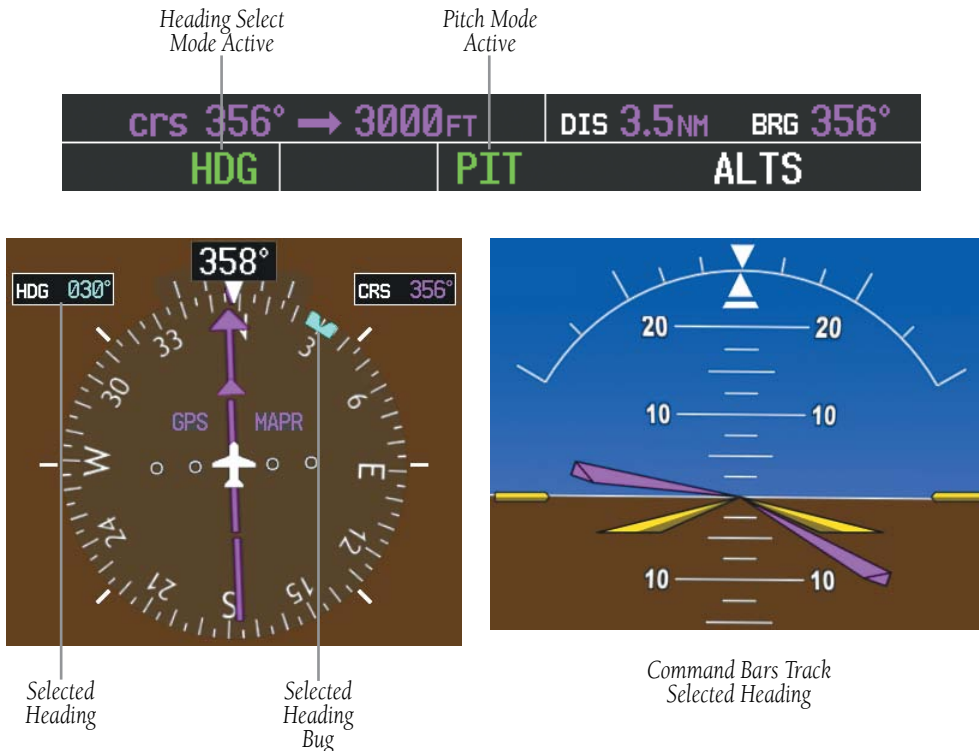

Figure 6-21 Heading Select Mode

Turns are commanded in the same direction as Selected Heading Bug movement, even if the bug is turned more than 180° from the present heading (e.g., a 270° turn to the right). However, Selected Heading changes of more than 330° at a time result in turn reversals.

Navigation Mode (GPS, VOR, LOC)



NOTE: *The selected navigation receiver must have a valid VOR or LOC signal or active GPS course for the flight director to enter Navigation Mode.*

Pressing the **NAV** Key selects Navigation Mode. Navigation Mode acquires and tracks the selected navigation source on the HSI (GPS, VOR, LOC). The flight director follows GPS roll steering commands when GPS is the selected navigation source.

When the HSI is coupled to VOR or LOC, the flight director creates roll steering commands from the Selected Course and deviation. Navigation Mode can also be used to fly non-precision GPS and LOC approaches where glideslope capture is not required.

If the Course Deviation Indicator (CDI) shows greater than one dot when the **NAV** Key is pressed, the selected mode is armed. The armed annunciation appears in white to the left of the active roll mode. For cases where the projected course is offset a large distance from the present course for turn anticipation, GPS Navigation Mode can be activated with crosstrack error up to 10 nm when the **NAV** Key is pressed.



Figure 6-23 GPS Navigation Mode Armed

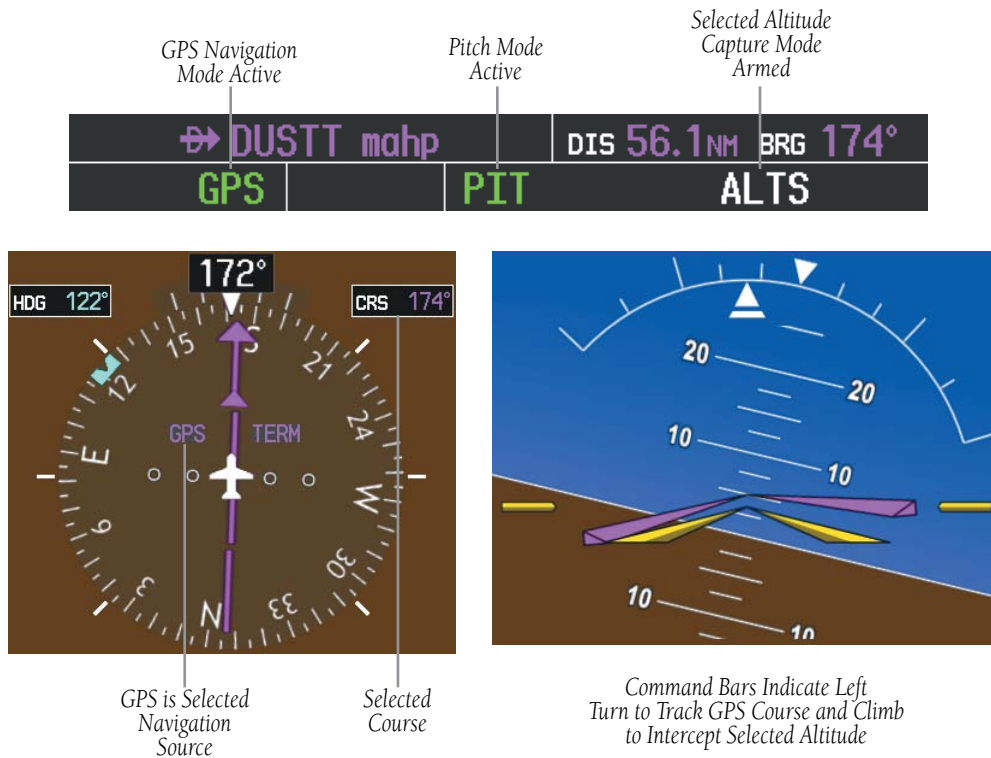

Figure 6-22 Navigation Mode

When the CDI has automatically switched from GPS to LOC during a LOC/ILS approach, GPS Navigation Mode remains active, providing GPS steering guidance until the localizer signal is captured. LOC Navigation Mode is armed in anticipation of localizer signal capture if the **APR** Key is not pressed prior to the automatic source switch.

If Navigation Mode is active and either of the following occur, the flight director reverts to Roll Hold Mode (wings rolled level):

- Different VOR is tuned while in VOR Navigation Mode (VOR Navigation Mode reverts to armed)
- Navigation source is manually switched
- Localizer signal is not captured by the final approach fix (FAF)

Changing the Selected Course

The Selected Course on the PFD is controlled using the **CRS** Knob. Pressing the **CWS** Button and hand-flying the aircraft does not change the Selected Course while in Navigation Mode. The autopilot guides the aircraft back to the Selected Course (or GPS flight plan) when the **CWS** Button is released.

Approach Mode (GPS, VAPP, LOC)



NOTE: *The selected navigation receiver must have a valid VOR or LOC signal or active GPS course for the flight director to enter Approach Mode.*

Approach Mode is activated when the **APR** Key is pressed. Approach Mode acquires and tracks the selected navigation receiver on the HSI (GPS, VOR, or LOC), depending on the loaded approach. This mode uses the selected navigation receiver deviation and desired course inputs to fly the approach. Approach Mode provides greater sensitivity for signal tracking than Navigation Mode.

Pressing the **APR** Key when the CDI is greater than one dot arms the selected approach mode (annunciated

in white to the left of the active roll mode). If the selected navigation receiver is GPS, pressing the **APR** Key arms GPS Approach Mode, provided that a GPS approach has been loaded into the flight plan. If the loaded approach provides SBAS-based vertical guidance, Glidepath Mode is also armed (Figure 6-16). If GPS Approach Mode is selected while in GPS Navigation Mode, capture can occur with crosstrack error of up to 2 nm.



Figure 6-24 Navigation/Approach Mode Armed

LOC Approach Mode allows the autopilot to fly a LOC/ILS approach with a glideslope. LOC Approach Mode is armed (along with Glideslope Mode; see Figure 6-17) when the **APR** Key is pressed and either of the following have been done:

- Navigation source is set to LOC
- A LOC/ILS approach is loaded into the flight plan and the corresponding localizer frequency tuned (even if the selected navigation source is GPS)

Localizer capture is suppressed until the navigation source is changed to LOC.

If Approach Mode is active and either of the following occur, the flight director reverts to Roll Hold Mode (wings rolled level):

- Vectors-to-Final is activated
- Navigation source is manually switched
- Localizer signal is not captured by the final approach fix (FAF)

Changing the Selected Course

The Selected Course on the PFD is controlled using the **CRS** Knob. Pressing the **CWS** Button and hand-flying the aircraft does not change the Selected Course while in Approach Mode. The autopilot guides the aircraft back to the Selected Course (or GPS flight plan) when the **CWS** Button is released.

Intercepting and Flying a DME Arc

The AFCS will intercept and track a DME arc that is part of the active flight plan provided that GPS Navigation Mode is engaged, GPS is the active navigation source on the CDI, and the DME arc segment is the active flight plan leg. Since navigation of DME arcs is based on GPS, when the **APR** Key is pressed and LOC or VOR Approach Mode is armed prior to reaching the Initial Approach Fix (IAF), Approach Mode will not activate until the arc segment is completed.

If the arc is intercepted at a location other than the published IAF (i.e. ATC provides vectors to intercept the arc) and subsequently Heading Mode or Roll Mode is selected, the AFCS will not automatically intercept or track the arc unless the arc leg of the flight plan is activated GPS Navigation Mode is armed. The AFCS will not intercept and fly a DME arc before reaching an IAF that defines the beginning of the arc segment. Likewise, if at any point while established on the DME arc GPS Navigation Mode is deselected, the AFCS will no longer track the arc.

Backcourse Mode (BC)



NOTE: When making a backcourse approach, set the Selected Course to the localizer front course.

Backcourse Mode captures and tracks a localizer signal. The mode may be selected by pressing the **BC** Key. Backcourse Mode is armed if the CDI is greater than one dot when the mode is selected. The flight director creates steering commands from the Selected Course and deviation when in Backcourse Mode.

Changing the Selected Course

The Selected Course on the PFD is controlled using the **CRS** Knob. Pressing the **CWS** Button and hand-flying the aircraft does not change course while in Backcourse Mode. The autopilot guides the aircraft back to the Selected Course when the **CWS** Button is released.

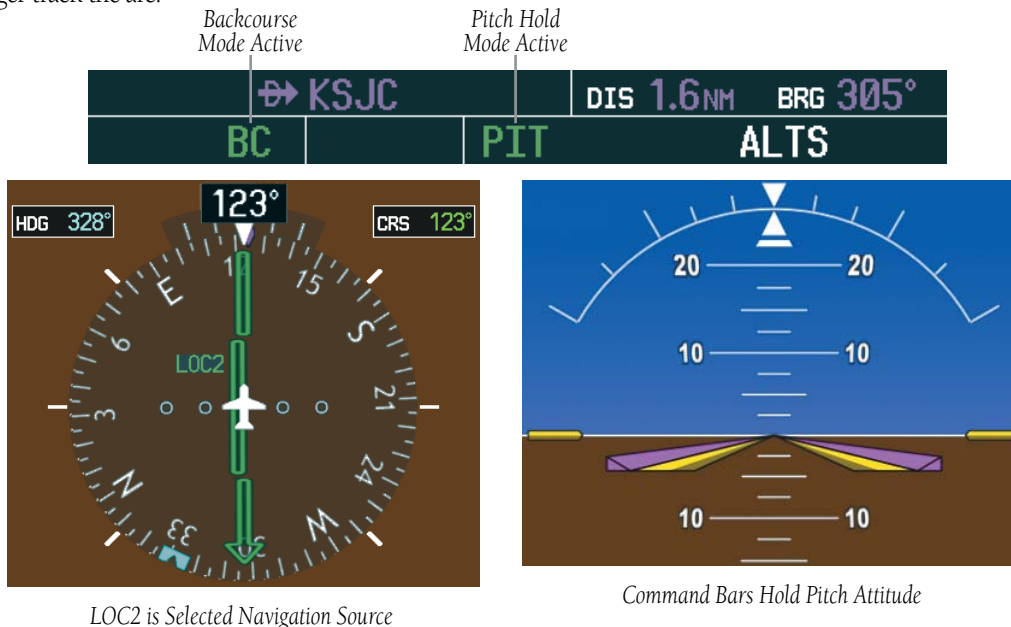

Figure 6-25 Backcourse Mode

6.4 AUTOPILOT OPERATION



NOTE: Refer to the AFM for specific instructions regarding emergency procedures.

Cessna Nav III's autopilot operates flight control surface servos to provide automatic flight control. The autopilot controls the aircraft pitch and roll attitudes following commands received from the flight director. Pitch autotrim provides trim commands to the pitch trim adapter to relieve any sustained effort required by the pitch servo.

Flight Control

Pitch and roll commands are provided to the servos, based on the active flight director modes. Servo motor control limits the maximum servo speed and torque. The servo gearboxes are equipped with slip-clutches set to certain values. This allows the servos to be overridden in case of an emergency.

Pitch Axis and Pitch Trim

The autopilot pitch axis uses pitch rate to stabilize the aircraft pitch attitude during upsets and flight director maneuvers. Flight director pitch commands are rate- and attitude-limited, combined with pitch damper control, and sent to the pitch servo motor. The pitch servo measures the output effort (torque) and provides this signal to the pitch trim servo. The pitch trim servo commands the motor to reduce the average pitch servo effort.

When the autopilot is not engaged, the pitch trim servo may be used to provide manual electric trim. This allows the aircraft to be trimmed using a control stick switch rather than the trim wheel. Manual trim commands are generated with the **MET** Switch. Trim speeds are scheduled with airspeed to provide more consistent response.

Roll Axis

The autopilot roll axis uses roll rate to stabilize aircraft roll attitude during upsets and flight director maneuvers. The flight director roll commands are rate- and attitude-limited, combined with roll damper control, and sent to the roll servo motor.

Engaging the Autopilot



NOTE: Autopilot engagement/disengagement is not equivalent to servo engagement/disengagement. Use the **CWS** Button to disengage the pitch and roll servos while the autopilot remains active.

When the **AP** Key is pressed, the autopilot and flight director (if not already engaged) are activated. Engagement is indicated by a green 'AP' annunciation in the center of the AFCS Status Box. The flight director engages in Pitch and Roll Hold modes when initially activated.



Figure 6-26 Autopilot Engaged

Control Wheel Steering

During autopilot operation, the aircraft may be hand-flown without disengaging the autopilot. Pressing and holding the **CWS** Button disengages the pitch and roll servos from the flight control surfaces and allows the aircraft to be hand-flown. At the same time, the flight director is synchronized to the aircraft attitude during the maneuver. The ‘AP’ annunciation is temporarily replaced by ‘CWS’ in white for the duration of CWS maneuvers.

In most scenarios, releasing the **CWS** Button reengages the autopilot with a new reference. Refer to the flight director modes section for CWS behavior in each mode.



Figure 6-27 CWS Annunciation

Disengaging the Autopilot

Automatic disengagement occurs due to:

- System failure
- Inability to compute default flight director modes (FD also disengages automatically)
- Invalid sensor data

Automatic autopilot disengagement is indicated by a flashing red ‘AP’ annunciation and by the autopilot disconnect aural alert, which continue until acknowledged by pushing the **AP DISC** or **MET** Switch.



Figure 6-28 Automatic Autopilot Disengagement

The autopilot is manually disengaged by pushing the **AP DISC** Switch, **GA** Switch, **MET ARM** Switch, or the **AP** Key on the MFD. Manual disengagement is indicated by a five-second flashing yellow ‘AP’ annunciation and a three-second autopilot disconnect aural alert. After manual disengagement, the autopilot disconnect aural alert may be cancelled by pushing the **MET ARM** or **AP DISC** Switch (**AP DISC** Switch also cancels the flashing ‘AP’ annunciation).



Figure 6-29 Manual Autopilot Disengagement

6.5 EXAMPLE PROCEDURES



NOTE: The following example flight plan and diagrams (not to be used for navigation) in this section are for instructional purposes only and should be considered not current. Numbered portions of accompanying diagrams correspond to numbered procedure steps.

This scenario-based set of procedures (based on the example flight plan found in the Flight Management Section) shows various GFC 700 AFCS modes used during a flight. In this scenario, the aircraft departs Charles B. Wheeler Downtown Airport (KMKC), enroute to Colorado Springs Airport (KCOS). After departure, the aircraft climbs to 12,000 ft and airway V4 is intercepted, following ATC vectors.

Airway V4 is flown to Salina VOR (SLN) using VOR navigation, then airway V244 is flown using GPS Navigation. The ILS approach for runway 35L and LPV (SBAS) approach for runway 35R are shown and a missed approach is executed.

Departure

Climbing to the Selected Altitude and flying an assigned heading:

- 1) Before takeoff, set the Selected Altitude to 12,000 feet using the **ALT** Knob.
- 2) After takeoff, hand-fly the aircraft to an altitude above the autopilot minimum engage height.
- 3) In this example, Vertical Speed Mode is used to capture the Selected Altitude (Pitch Hold, Vertical Speed, or Flight Level Change Mode may be used).
 - a) Press the **VS** Key to activate Vertical Speed Mode.



The Vertical Speed Reference may be adjusted after Vertical Speed Mode is selected using the **NOSE UP/NOSE DN** keys or pushing the **CWS** Button while hand-flying the aircraft to establish a new Vertical Speed Reference.

- b) Press the **AP** Key to engage the autopilot in a climb using Vertical Speed Mode.

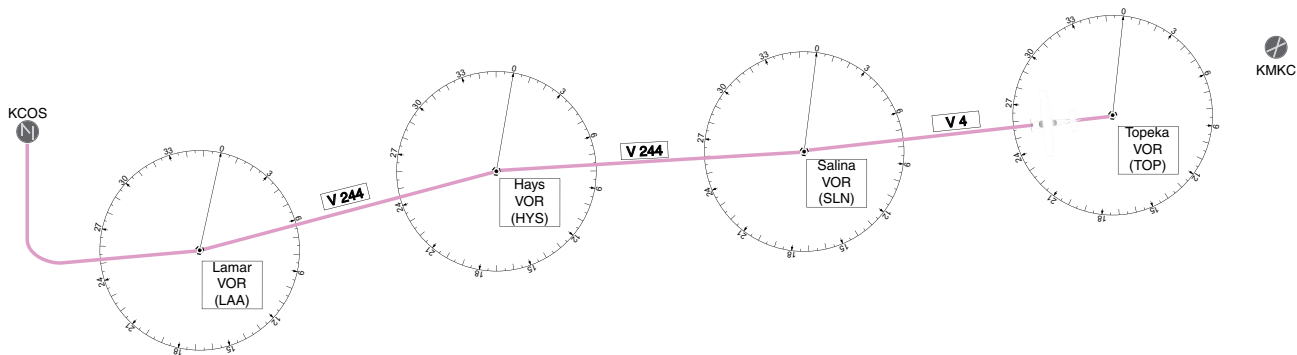

Figure 6-30 Flight Plan Overview

- Use the **HDG** Knob to set the Selected Heading, complying with ATC vectors to intercept Airway V4.

Press the **HDG** Key to activate Heading Select Mode while the autopilot is engaged in the climb. The autopilot follows the Selected Heading Bug on the HSI and turns the aircraft to the desired heading.

HDG | **AP** | **VS ↑ 500 FPM** | **ALTS**

- As the aircraft nears the Selected Altitude, the flight director transitions to Selected Altitude Capture Mode, indicated by the green 'ALTS' annunciation flashing for up to 10 seconds.

HDG | **AP** | **ALTS 12000 FT** | **ALT**

At 50 feet from the Selected Altitude, the green 'ALT' annunciation flashes for up to 10 seconds; the autopilot transitions to Altitude Hold Mode and levels the aircraft.

HDG | **AP** | **ALT 12000 FT**

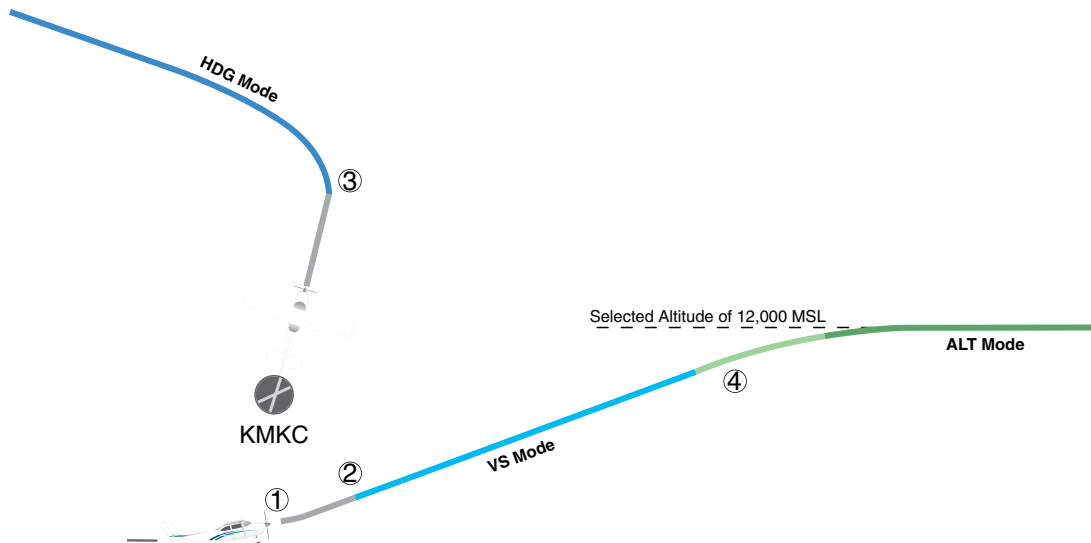

Figure 6-31 Departure

Intercepting a VOR Radial

During climb-out, the autopilot continues to fly the aircraft in Heading Select Mode. Airway V4 to Salina VOR (SLN) should now be intercepted. Since the enroute flight plan waypoints correspond to VORs, flight director Navigation Mode using either VOR or GPS as the navigation source may be used. In this scenario, VOR Navigation Mode is used for navigation to the first VOR waypoint in the flight plan.

Intercepting a VOR radial:

- 1) Arm VOR Navigation Mode:
 - a) Tune the VOR frequency.
 - b) Press the **CDI** Softkey to set the navigation source to VOR.
 - c) Use the **CRS** Knob to set the Selected Course to 255°. Note that at this point, the flight director is still in Heading Select Mode and the autopilot continues to fly 290°.

- d) Press the **NAV** Key. This arms VOR Navigation Mode and the white 'VOR' annunciation appears to the left of the active lateral mode.

VOR	HDG	AP	ALT	12000FT
-----	-----	----	-----	---------

- 2) As the aircraft nears the Selected Course, the flight director transitions from Heading Select to VOR Navigation Mode and the 'VOR' annunciation flashes green. The autopilot begins turning to intercept the Selected Course.

VOR	AP	ALT	12000FT
-----	----	-----	---------

- 3) The autopilot continues the turn until the aircraft is established on the Selected Course.

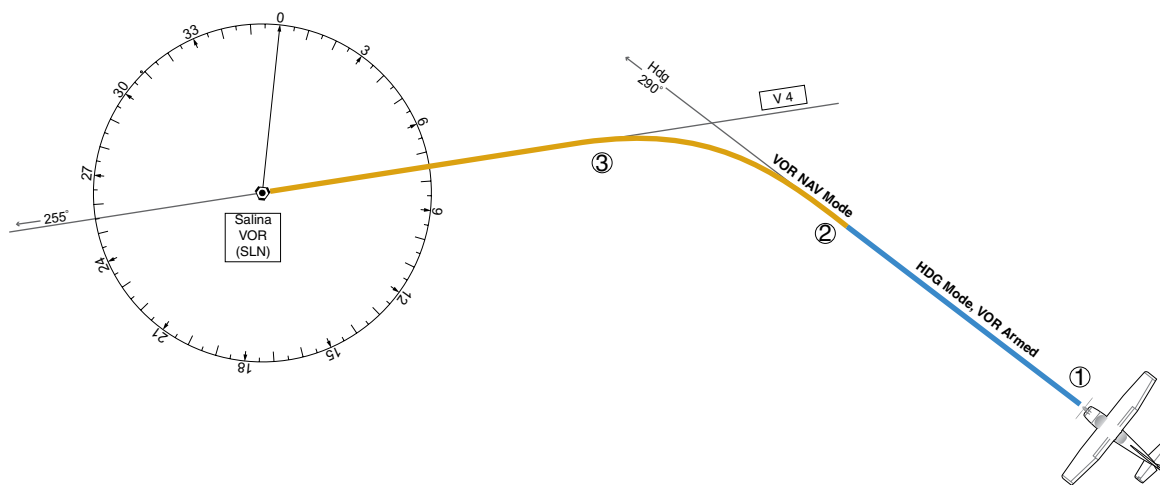

Figure 6-32 Intercepting a VOR Radial

Flying a Flight Plan/GPS Course



NOTE: Changing the navigation source cancels Navigation Mode and causes the flight director to revert back to Roll Hold Mode (wings rolled level).

As the aircraft closes on Salina VOR, GPS is used to navigate the next leg, airway V244. The aircraft is currently tracking inbound on Airway V4.

Flying a GPS flight plan:

- 1) Transition from VOR to GPS Navigation Mode:
 - a) Press the **CDI** Softkey until GPS is the selected navigation source.
 - b) Press the **NAV** Key to activate GPS Navigation Mode. The autopilot guides the aircraft along the active flight plan leg.

GPS | AP | ALT 12000FT

- 2) Following the flight plan, the autopilot continues to steer the aircraft under GPS guidance. Note that in GPS Navigation Mode, course changes defined by the flight plan are automatically made without pilot action required.

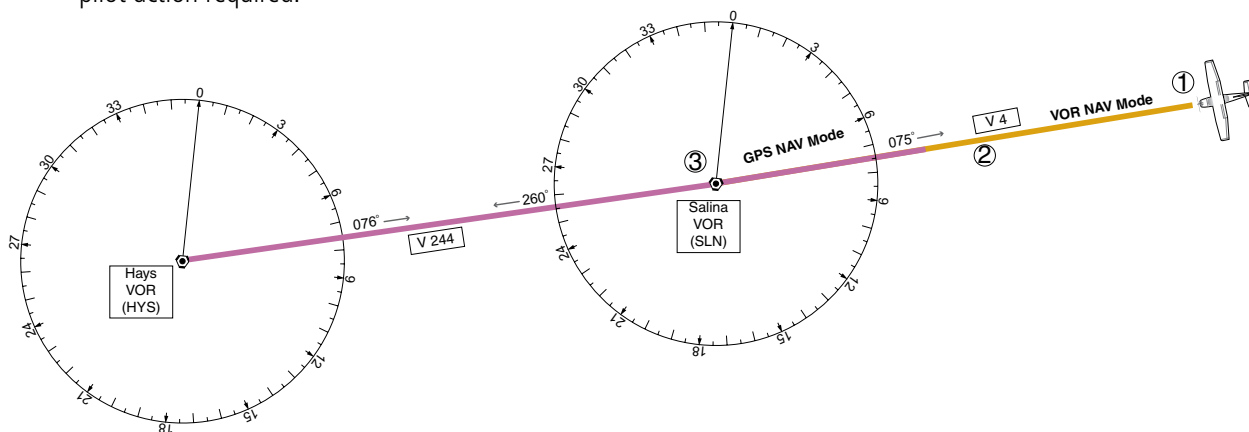

Figure 6-33 Transition to GPS Flight Plan

Descent

While flying the arrival procedure, the aircraft is cleared for descent in preparation for the approach to KCOS. Three methods are presented for the descent from 12,000 ft:

- Flight Level Change descent – Flight Level Change Mode can be used to descend to the Selected Altitude at a constant airspeed. This descent method does not account for flight plan waypoint altitude constraints.
- Vertical Path Tracking descent – Vertical Path Tracking Mode is used to follow the vertical descent path defined in the GPS flight plan. Altitude constraints correspond to waypoints in the flight plan. Before VNV flight control can provide vertical profile guidance, a VNV flight plan must be entered and enabled.
- Non-path descent in a VNV scenario – While the flight director is following VNV guidance for descent, Pitch Hold, Vertical Speed, or Flight Level Change Mode can be used to descend to the VNV Target Altitude prior to reaching the planned TOD. Flight Level Change Mode is used in the example.

Flight Level Change descent:

- 1) Select Flight Level Change Mode:
 - a) Using the **ALT** Knob, set the Selected Altitude to 10,000 feet.

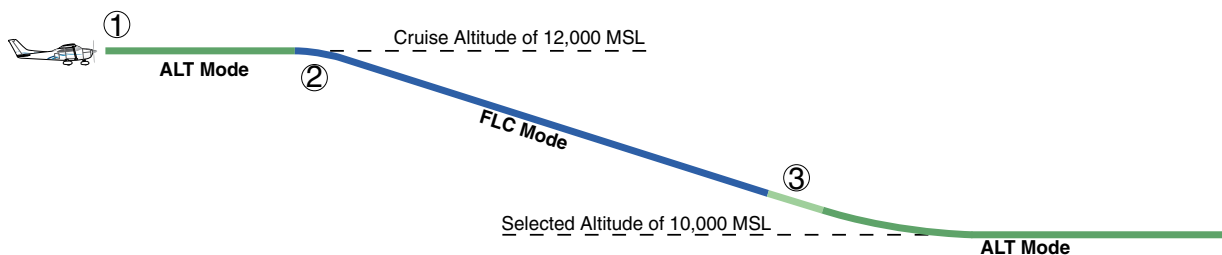

Figure 6-34 FLC Descent

- b) Press the **FLC** Key to activate Flight Level Change Mode. The annunciation 'FLC' appears next to the Airspeed Reference, which defaults to the current aircraft airspeed. Selected Altitude Capture Mode is armed automatically.

GPS | AP | FLC | 130KT ALTS

- 2) Use the **NOSE UP/NOSE DN** keys or push the **CWS** Button while hand-flying the aircraft to adjust the commanded airspeed while maintaining the same power, or reduce power to allow descent in Flight Level Change Mode while the autopilot maintains the current airspeed.
- 3) As the aircraft nears the Selected Altitude, the flight director transitions to Selected Altitude Capture Mode, indicated by the green 'ALTS' annunciation flashing for up to 10 seconds.

GPS | AP | ALTS 10000FT ALT

The green 'ALT' annunciation flashes for up to 10 seconds upon reaching 50 feet from the Selected Altitude; the autopilot transitions to Altitude Hold Mode and levels the aircraft.

GPS | AP | ALT 10000FT

Vertical Path Tracking descent to VNV Target Altitude:

- 1) Select VNV flight control:
 - a) Press the **VNV** Key to arm Vertical Path Tracking Mode. The white annunciation 'VPTH' appears.

GPS | AP | ALT 12000FT VPTH

- b) Using the **ALT** Knob, set the Selected Altitude at least 75 feet below the flight plan's VNV Target Altitude of 10,000 feet.

If the Selected Altitude is not adequately adjusted below the VNV Target Altitude, the flight director commands descent to the Selected Altitude rather than the VNV Target Altitude once Vertical Path Tracking Mode becomes active (ALTS is armed rather than ALTV).

- c) If Vertical Path Tracking Mode is armed more than 5 minutes prior to descent path capture, acknowledgment is required for the flight director to transition from Altitude Hold to Vertical Path Tracking Mode. To proceed with descent path capture if the white 'VPTH' annunciation begins flashing, do one of the following:

- Turn the ALT Knob to adjust the Selected Altitude
- Press the **VNV** Key

If the descent is not confirmed by the time of interception, Vertical Path Tracking Mode remains armed and the descent is not captured.

- 2) When the top of descent (TOD) is reached, the flight director transitions to Vertical Path Tracking Mode and begins the descent to the VNV Target Altitude. Intention to capture the VNV Target Altitude is indicated by the white 'ALTV' annunciation.

GPS | AP | VPTH | ALTV

- 3) As the aircraft nears the VNV Target Altitude, the flight director transitions to VNV Target Altitude Capture Mode, indicated by the green 'ALTV' annunciation flashing for up to 10 seconds.

GPS | AP | ALTV10000FT ALT

The green 'ALT' annunciation flashes for up to 10 seconds upon reaching 50 feet from the VNV Target Altitude; the autopilot transitions to Altitude Hold Mode and levels the aircraft at the vertical waypoint.

GPS | AP | ALT 10000FT

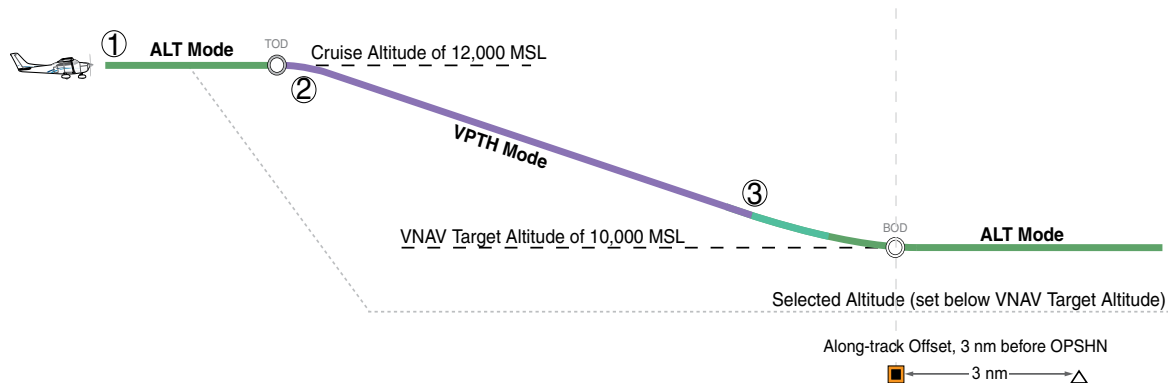

Figure 6-35 VPTH Descent

Non-path descent using Flight Level Change Mode:

- 1) Command a non-path descent using Flight Level Change Mode:
 - a) Using the **ALT** Knob, set the Selected Altitude below the current aircraft altitude to an altitude (in this case, 9,400 feet) at which to level off between VNV flight plan altitudes.
 - b) Press the **FLC** Key before the planned TOD during an altitude hold while VPTH is armed. The Airspeed Reference defaults to the current aircraft airspeed. Vertical Path Tracking and Selected Altitude Capture Mode are armed automatically.

GPS	AP	FLC	130KT	ALTS	VPTH
-----	----	-----	-------	------	------

- 2) Reduce power to allow descent in Flight Level Change Mode. The autopilot maintains the Airspeed Reference.
- 3) As the aircraft nears the Selected Altitude, the flight director transitions to Selected Altitude Capture Mode, indicated by the green 'ALTS' annunciation flashing for up to 10 seconds.

GPS	AP	ALTS	9400FT	ALT	VPTH
-----	----	------	--------	-----	------

The green 'ALT' annunciation flashes for up to 10 seconds upon reaching 50 feet from the Selected Altitude; the autopilot transitions to Altitude Hold Mode and levels the aircraft.

GPS	AP	ALT	9400FT	VPTH
-----	----	-----	--------	------

- 4) When the next TOD is reached, Vertical Path Tracking becomes active (may require acknowledgment to allow descent path capture).

GPS	AP	VPTH	ALT
-----	----	------	-----

- 5) As the aircraft nears the VNV Target Altitude, the flight director transitions to VNV Target Altitude Capture Mode, indicated by the green 'ALTV' annunciation flashing for up to 10 seconds.

GPS	AP	ALTV	9000FT	ALT
-----	----	------	--------	-----

The green 'ALT' annunciation flashes for up to 10 seconds upon reaching 50 feet from the VNV Target Altitude; the autopilot transitions to Altitude Hold Mode and levels the aircraft at the vertical waypoint.

GPS	AP	ALT	9000FT
-----	----	-----	--------

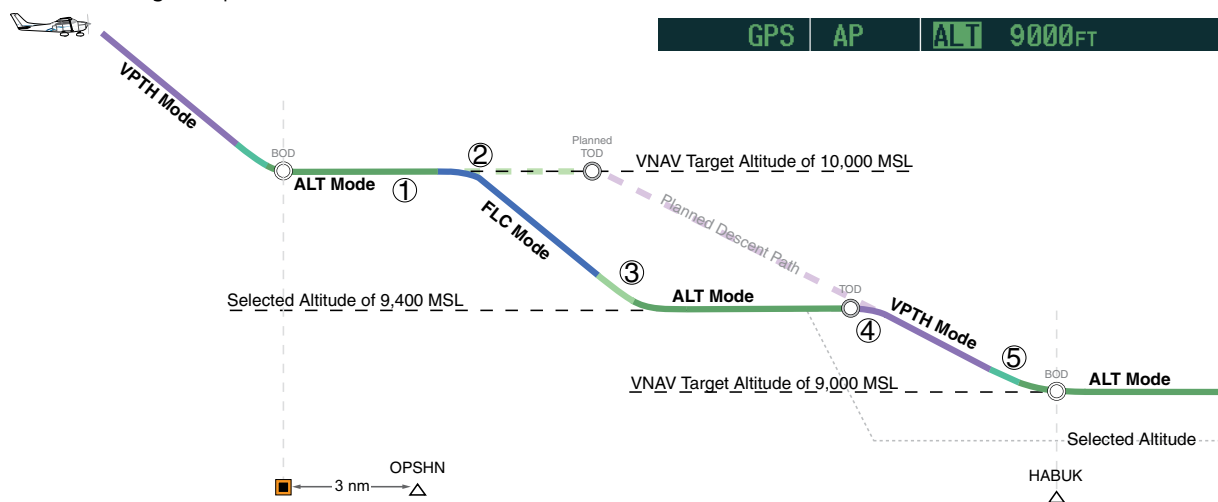

Figure 6-36 Non-path Descent

Approach



NOTE: If an approach contains a DME arc, the arc must be flown in Navigation Mode with the GFC 700. When receiving vectors from ATC, Navigation Mode must be selected prior to intercepting the ARC.

Flying an ILS approach:

- 1) Transition from GPS Navigation Mode to Heading Select Mode.
 - a) Select the Runway 35L ILS approach for KCOS and select 'VECTORS' for the transition. Load and activate the approach into the flight plan.
 - b) Use the **HDG** Knob to set the Selected Heading after getting vectors from ATC.
 - c) Press the **HDG** Key. The autopilot turns the aircraft to the desired heading.
 - d) Use Heading Select Mode to comply with ATC vectors as requested.

GPS	AP	ALTV 9000FT ALT
-----	----	-----------------

- 2) Arm LOC Approach and Glideslope modes.
 - a) Ensure the appropriate localizer frequency is tuned.
 - b) Press the **APR** Key when cleared for approach to arm Approach and Glideslope modes. 'LOC' and 'GS' appear in white as armed mode annunciations.

GPS	AP	ALTV 9000FT ALT
-----	----	-----------------

- c) The navigation source automatically switches to LOC. After this switch occurs, the localizer signal can be captured, and the flight directors determine when to begin the turn to intercept the final approach course. The flight director now provides guidance to the missed approach point.

- 3) There are two options available at this point, as the autopilot flies the ILS approach:
 - Push the **AP DISC** Switch at the decision height and land the aircraft.
 - Use the **GA** Switch to execute a missed approach.

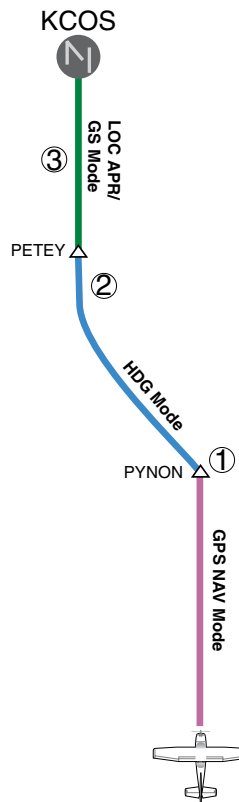

Figure 6-37 ILS Approach to KCOS

Flying a RNAV GPS approach with vertical guidance:

- 1) Arm flight director modes for a RNAV GPS approach with vertical guidance:
 - a) Make sure the navigation source is set to GPS (use **CDI** Softkey to change navigation source).
 - b) Select the Runway 35R LPV approach for KCOS. Load and activate the approach into the flight plan.
- 2) Press the **APR** Key once clearance for approach has been received. GPS Approach Mode is activated and Glidepath Mode is armed.

GPS	AP	VPTH	ALTS GP
-----	----	------	---------

- 3) Once the glidepath is captured, Glidepath Mode becomes active. The flight director now provides guidance to the missed approach point.

GPS	AP	GP
-----	----	----

- 4) There are two options available at this point, as the autopilot flies the approach:
 - Push the **AP DISC** Switch at the Decision height and land the aircraft.
 - Use the **GA** Switch to execute a missed approach.

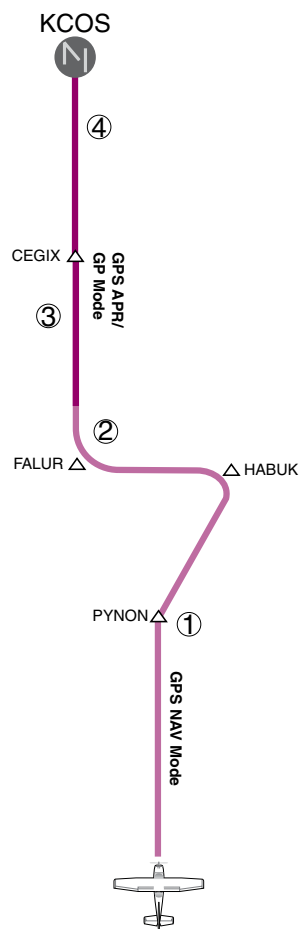

Figure 6-38 LPV Approach to KCOS

Go Around/Missed Approach



NOTE: As a result of calculations performed by the system while flying the holding pattern, the display may re-size automatically and the aircraft may not precisely track the holding pattern.

Flying a missed approach:

- 1) Push the **GA** Switch at the Decision height and apply go around power to execute a missed approach. The flight director Command Bars establish a nose-up climb to follow. If flying an ILS or LOC approach the CDI also switches to GPS as the navigation source.

Note that when the **GA** Switch is pushed, the missed approach is activated and the autopilot disconnects, indicated by the 'AP' annunciation flashing yellow for 5 seconds and the autopilot disconnect aural alert.

Flashes 5 sec

GA	AP	GA	ALT
----	----	----	-----

- 2) Start the climb to the prescribed altitude in the published Missed Approach Procedure (in this case, 10,000 ft).
 - a) After climbing to altitude exceeding the autopilot minimum engage height, press the **AP** Key to re-engage the autopilot.
 - b) Press the **NAV** Key to have the autopilot fly to the hold.

GPS	AP	PIT	ALT
-----	----	-----	-----

- 3) Use the **ALT** Knob to set a Selected Altitude to hold.

To hold the current airspeed during the climb, press the **FLC** Key.

GPS	AP	FLC	100KT	ALTS
-----	----	-----	-------	------

As the aircraft nears the Selected Altitude, the flight director transitions to Selected Altitude Capture Mode, indicated by the green 'ALTS' annunciation flashing for up to 10 seconds.

GPS	AP	ALTS 10000FT	ALT
-----	----	--------------	-----

The green 'ALT' annunciation flashes for up to 10 seconds upon reaching 50 feet from the Selected Altitude; the autopilot transitions to Altitude Hold Mode and levels the aircraft.

GPS	AP	ALT 10000FT
-----	----	-------------

- 4) The autopilot flies the holding pattern after the missed approach is activated. Annunciations are displayed in the Navigation Status Box, above the AFCS Status Box.

6.0NM	MOGAL	DIS 2.2NM	BRG 149°
GPS	AP	ALT 10000FT	

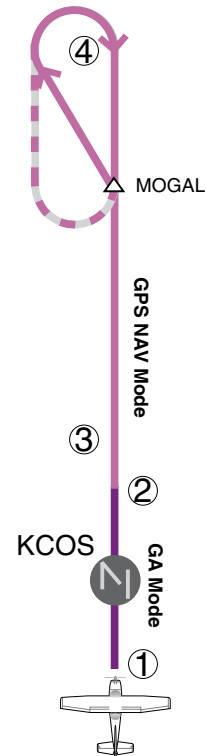

Figure 6-39 Go Around/Missed Approach

6.6 AFCS ANNUNCIATIONS AND ALERTS

AFCS Status Alerts

The following annunciations (listed in order of increasing priority) can appear on the PFD above the Airspeed and Attitude indicators. Only one annunciation may occur at a time, and messages are prioritized by criticality.

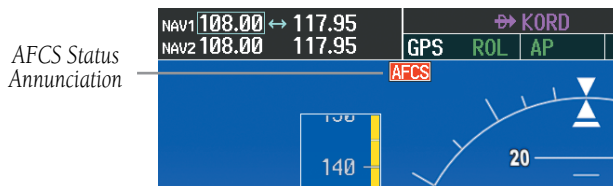

Figure 6-40 AFCS Status Annunciation

Alert Condition	Annunciation	Description
Aileron Mistrim Right	AIL→	Roll servo providing sustained force in the indicated direction
Aileron Mistrim Left	←AIL	
Elevator Mistrim Down	↓ELE	Pitch servo providing sustained force in the indicated direction
Elevator Mistrim Up	↑ELE	
Pitch Trim Failure (or stuck MET Switch)	PTRM	If AP engaged, take control of the aircraft and disengage AP If AP disengaged, move MET switches separately to unstick
Roll Failure	ROLL	Roll axis control failure; AP inoperative
Pitch Failure	PTCH	Pitch axis control failure; AP inoperative
System Failure	AFCS	AP and MET are unavailable; FD may still be available
Preflight Test	PFT	Performing preflight system test; aural alert sounds at completion Do not press the AP DISC Switch during servo power-up and preflight system tests as this may cause the preflight system test to fail or never to start (if servos fail their power-up tests). Power must be cycled to the servos to remedy the situation.
	PFT	Preflight system test failed; aural alert sounds at failure

Table 6-4 AFCS Status Field Alerts

Overspeed Protection

Overspeed protection is provided in situations where the flight director cannot acquire and maintain the vertical Mode Reference for the selected vertical mode without exceeding the certified maximum autopilot airspeed.

When an autopilot overspeed condition occurs, the Airspeed Reference appears in a box above the Airspeed Indicator, flashing a yellow 'MAXSPD' annunciation. Engine power should be reduced and/or the pitch reference adjusted to slow the aircraft. The annunciation disappears when the overspeed condition is resolved.

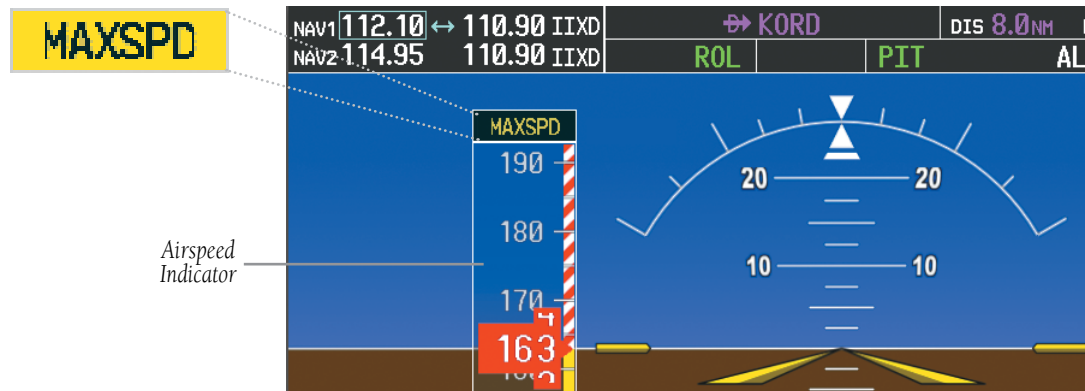
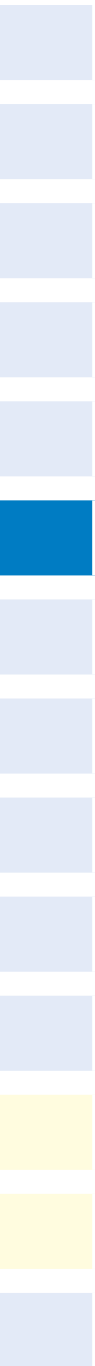

Figure 6-41 Overspeed Annunciation



Blank Page

SECTION 7: NAVIGATION

The majority of the following discussions pertain to the Multi Function Display. In discussions pertaining to the PFD, the controls are located on the PFD.

7.1 NAVIGATION MAP PAGE



WARNING: The map display should only be used for situational awareness. Any map display indication should be compared with approved navigation sources.

Select the MAP Page Group

- 1) Turn the large **FMS** Knob until the 'MAP' page group is selected.
- 2) Turn the small **FMS** Knob to select NAVIGATION MAP in the selection list.

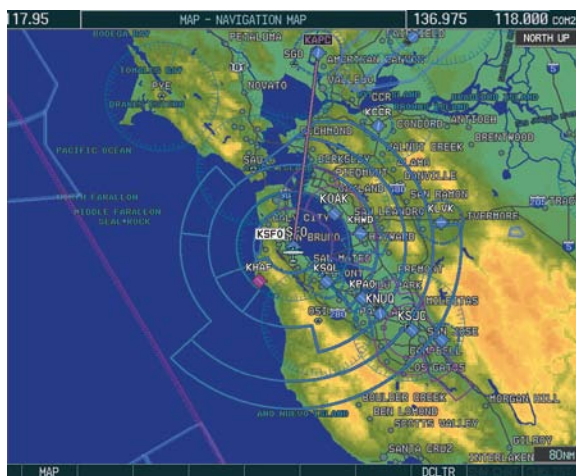

Figure 7-1 Navigation Map Page (Enroute)

7.2 DIRECT-TO NAVIGATION

Direct-to Navigation from the MFD



Figure 7-2 MFD Direct-to Window

Enter a Direct-to Destination

- 1) Press the **Direct-to** (D▶) Key.
- 2) Enter the destination waypoint identifier.
- 3) Press the **ENT** Key to confirm the identifier. The 'Activate?' field is highlighted.
- 4) If no altitude constraint or course is desired, press the **ENT** Key to activate. To enter an altitude constraint, proceed to step 5.
- 5) Turn the large **FMS** Knob to place the cursor over the 'VNAV' altitude field.
- 6) Enter the desired altitude.
- 7) Press the **ENT** Key. The option to select 'MSL' or 'AGL' is now displayed.
- 8) Turn the small **FMS** Knob to select 'MSL' or 'AGL'.

- 9) Press the **ENT** Key. The cursor is placed in the 'VNV' offset distance field.
- 10) Enter the desired target altitude offset from the selected Direct-to.
- 11) Press the **ENT** Key to highlight 'Activate?' or turn the large **FMS** Knob to highlight the 'COURSE' field.
- 12) Enter the desired course to the waypoint.
- 13) Press the **ENT** Key to highlight 'ACTIVATE?'.
- 14) Press the **ENT** Key again to activate the Direct-to.

Select a Direct-to Destination to a Flight Plan Waypoint

- 1) While navigating an active flight plan, press the **Direct-to** (**D>**) Key.
- 2) Turn the small **FMS** Knob to the left to display a list of flight plan waypoints as shown in Figure 7-3.



Figure 7-3 Flight Plan Waypoint List (MFD)

- 3) Turn the large **FMS** Knob to select the desired waypoint.
- 4) Press the **ENT** Key. The cursor is now displayed on 'ACTIVATE?'.
- 5) Press the **ENT** Key again to activate a Direct-to.

Select a Direct-to Destination to a Nearest Airport

- 1) Press the **Direct-to** (**D>**) Key.
- 2) Turn the small **FMS** Knob to the left. Initially, a flight plan waypoint list is displayed as in Figure 7-3. The list is populated only when navigating a flight plan.



Figure 7-4 Nearest Airport List (MFD)

- 3) Turn the small **FMS** Knob to the right to display the 'NRST' airports to the aircraft's current position as shown in Figure 7-4.
- 4) Turn the large **FMS** Knob to select the desired airport.
- 5) Press the **ENT** Key. The cursor is now displayed on 'ACTIVATE?'.
- 6) Press the **ENT** Key again to activate a Direct-to.

Select a Direct-to Destination to a Recently Entered Identifier

- 1) Press the **Direct-to** (**D>**) Key.
- 2) Turn the small **FMS** Knob to the left. Initially, a flight plan waypoint list is displayed as in Figure 7-3. The list is populated only when navigating a flight plan.



Figure 7-5 Recently Entered Waypoints List (MFD)

- 3) Turn the small **FMS** Knob to the right to display the 'RECENT' waypoints as shown in Figure 7-5.
- 4) Turn the large **FMS** Knob to select the desired airport.
- 5) Press the **ENT** Key. The cursor is now displayed on 'ACTIVATE?'.
- 6) Press **ENT** again to activate a Direct-to.

Re-center the CDI to the Destination Waypoint

Press the **Direct-to** (**D▶**) Key, followed by pressing the **ENT** Key twice. If a missed approach point (MAP) is the current destination, the approach is canceled.

Manually Define the Active Direct-to

- 1) Press the **Direct-to** (**D▶**) Key.
- 2) Turn the large **FMS** Knob to highlight the 'VNAV' altitude field.
- 3) Enter the desired altitude.
- 4) Press the **ENT** Key. The option to select 'MSL' or 'AGL' is now displayed.
- 5) Turn the small **FMS** Knob to select 'MSL' or 'AGL'.
- 6) Press the **ENT** Key. The cursor now highlights the VNAV offset field.
- 7) Enter the desired offset distance.
- 8) Press the **ENT** Key.

- 9) Turn the large **FMS** Knob to place the cursor in the 'COURSE' field.
- 10) Enter the desired course.
- 11) Press the **ENT** Key. The cursor now highlights 'ACTIVATE?'.
- 12) Press the **ENT** Key again to begin navigation using the selected destination, altitude constraint, and course.

Canceling Direct-to Navigation

- 1) Press the **Direct-to** (**D▶**) Key.
- 2) Press the **MENU** Key to display the Direct-to options menu.
- 3) With 'Cancel Direct-To NAV' highlighted, press the **ENT** Key. If a flight plan is still active, the G1000 resumes navigating the flight plan along the closest leg.

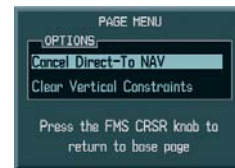

Figure 7-6 Canceling Direct-to Navigation

Direct-to Navigation from the PFD

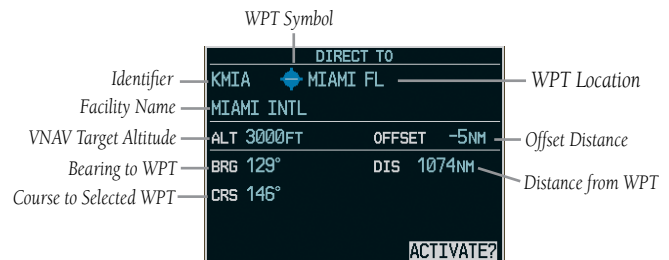

Figure 7-7 PFD Direct-to Window

Enter a Direct-to Destination

- 1) Press the Direct-to Key (D▶).
- 2) Turn the large **FMS** Knob to place the cursor in the desired selection field.
- 3) Turn the small **FMS** Knob to begin selecting the desired identifier, location, etc.
- 4) Press the **ENT** Key.
- 5) The cursor is now flashing on 'ACTIVATE?'. If no altitude constraint or course is desired, press the **ENT** Key to activate. To enter an altitude constraint, proceed to step 6.
- 6) Turn the large **FMS** Knob to place the cursor over the 'VNAV' altitude field.
- 7) Turn the small **FMS** Knob to enter the desired VNAV altitude.
- 8) Press the **ENT** Key. The option to select 'MSL' or 'AGL' is now displayed.
- 9) Turn the small **FMS** Knob to select 'MSL' or 'AGL'.
- 10) Press the **ENT** Key. The cursor is placed in the 'VNAV' offset distance field.
- 11) Turn the small **FMS** Knob to enter the desired target altitude offset from the selected Direct-to.
- 12) Press the **ENT** Key to highlight 'Activate?' or turn the large **FMS** Knob to highlight the 'COURSE' field.
- 13) Turn the small **FMS** Knob to enter the desired course to the waypoint.
- 14) Press the **ENT** Key to highlight 'ACTIVATE?'.
15) Press the **ENT** Key again to activate the Direct-to.

Select a Direct-to Destination to a Flight Plan Waypoint

- 1) While navigating an active flight plan, press the **Direct-to** (D▶) Key.
- 2) Turn the small **FMS** Knob to the left to display a list of flight plan waypoints as shown in Figure 7-8.

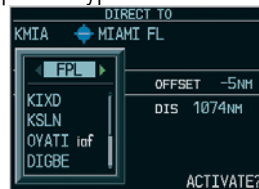

Figure 7-8 Flight Plan Waypoint List (PFD)

- 3) Turn the large **FMS** Knob to select the desired waypoint.
- 4) Press the **ENT** Key. The cursor is now displayed on 'ACTIVATE?'.
5) Press the **ENT** Key again to activate a Direct-to.

Select a Direct-to Destination to a Nearest Airport

- 1) Press the **Direct-to** (D▶) Key.
- 2) Turn the small **FMS** Knob to the left. Initially, a flight plan waypoint list is displayed as in Figure 7-8. The list is only populated when navigating a flight plan.

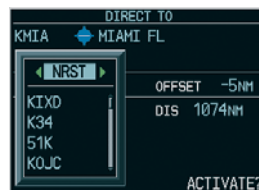

Figure 7-9 Nearest Airport List (PFD)

- 3) Turn the small **FMS** Knob to the right to display the 'NRST' airports to the aircraft's current position as shown in Figure 7-9.

- 4) Turn the large **FMS** Knob to select the desired airport.
- 5) Press the **ENT** Key. The cursor is now displayed on 'ACTIVATE?'.
- 6) Press the **ENT** Key again to activate a Direct-to.

Select a Direct-to Destination to a Recently Entered Identifier

- 1) Press the **Direct-to** (**D▶**) Key.
- 2) Turn the small **FMS** Knob to the left. Initially, a flight plan waypoint list is displayed as in Figure 7-8. The list is only populated when navigating a flight plan.



Figure 7-10 Recently Entered Waypoints List (PFD)

- 3) Turn the small **FMS** Knob to the right to display the 'RECENT' waypoints as shown in Figure 7-10.
- 4) Turn the large **FMS** Knob to select the desired airport.
- 5) Press the **ENT** Key. The cursor is now displayed on 'ACTIVATE?'.
- 6) Press the **ENT** Key again to activate a Direct-to.

Cancelling Direct-to Navigation

- 1) Press the **Direct-to** (**D▶**) Key.
- 2) Press the **MENU** Key to display the Options Window. The cursor flashes on 'Cancel Direct-to NAV'.
- 3) Press the **ENT** Key to cancel the direct-to.

7.3 NAVIGATING AN EXAMPLE FLIGHT PLAN



NOTE: The following example flight plan is for instructional purposes only. All database information depicted should be considered not current.

The following discussion is an example of navigating a flight plan with the SBAS capable GPS system while the G1000 provides vertical guidance through descents. A lateral flight plan (LNAV) would be navigated in much the same way, but would not include vertical guidance when the final approach course is active.

The example is a flight plan from KMKC to KCOS filed using the TIFTO2 departure, various Victor Airways, and the DBRY1 arrival with the transition at TBE. The flight plan includes an enroute altitude of 12,000 feet, an LPV (SBAS) approach selected for runway 35R, and a missed approach executed at the Missed Approach Point (MAP). A few enroute changes are demonstrated.

- 1) Prior to departure, the TIFTO2 departure, the airways, and the DBRY1 arrival at KCOS are loaded. See the Procedures section for loading departures and arrivals. Note the magenta arrow in Figure 7-104 indicating the active departure leg. After takeoff, ATC assigns a heading of 240°.

SECTION 7 – NAVIGATION

- 2) Figure 7-11 shows the aircraft on the assigned heading of 240°. 'TERM' (Terminal) is the current CDI flight phase displayed on the HSI indicating 1.0 nm CDI scaling.



Figure 7-11 Assigned Heading of 240°

- 3) ATC now assigns routing to join V4. A heading of 290° is assigned to intercept V4. The aircraft turns to heading 290° as seen in Figure 7-12.



Figure 7-12 Assigned Heading of 290°

- 4) Enter V4 into the flight plan.
 - a) Press the **FMS** Knob to activate the cursor.
 - b) The desired entry point for V4 (TOP) must be entered. Turn the large **FMS** Knob to highlight the desired flight plan insertion point (SLN) as shown in Figure 7-13. When the V4 entry point (TOP) is inserted, it is placed immediately above the highlighted waypoint (SLN) as indicated by the insertion point indicator (small blue triangle).

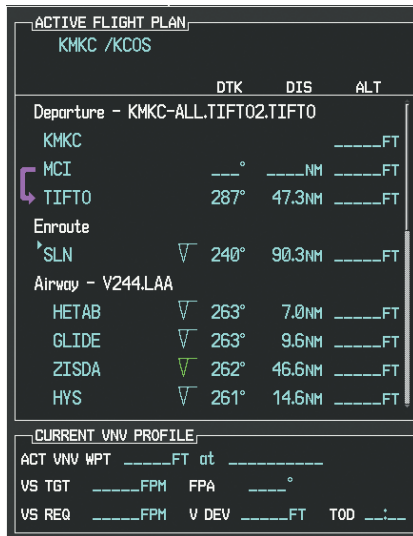

Figure 7-13 Begin Adding V4 to the Flight Plan

- c) Turn the small **FMS** Knob to display the Waypoint Information Window. Enter the desired entry point for V4, Topeka VOR (TOP), as shown in Figure 7-14.

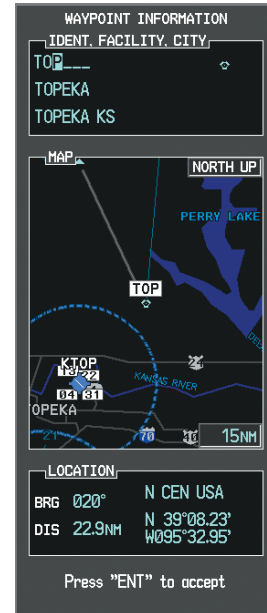

Figure 7-14 Entering V4 Entry Point

- d) Press the **ENT** Key. TOP is inserted into the flight plan as in Figure 7-15.

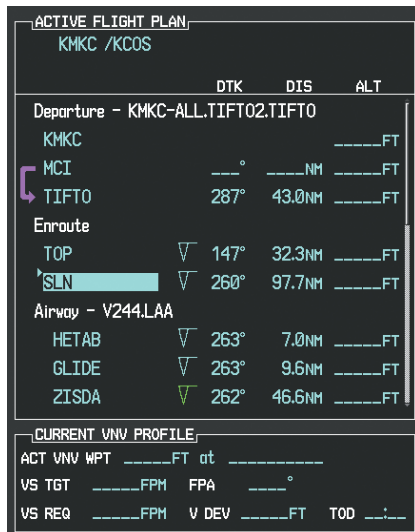

Figure 7-15 TOP Inserted into the Flight Plan

- e) With SLN still highlighted as in Figure 7-15, turn the small **FMS** Knob clockwise. The Waypoint Information Page is displayed and the **LD AIRWY** Softkey is now available.

- f) Press the **LD AIRWY** Softkey to display the list of available airways for TOP as seen in Figure 7-16.

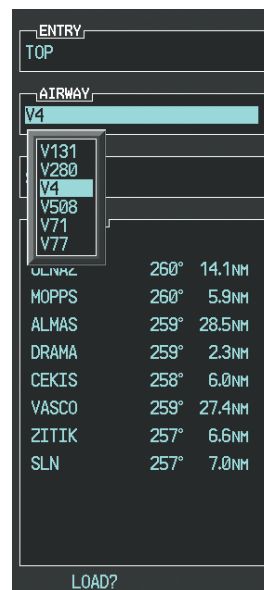

Figure 7-16 List of Available Airways for TOP

- g) Turn either **FMS** Knob to highlight V4 in the list as seen in Figure 7-16.

- h) Press the **ENT** Key. The list of available exits for V4 is now displayed as in Figure 7-17.

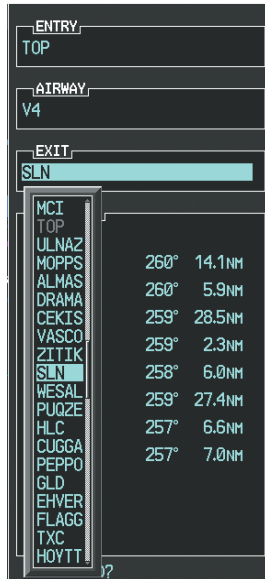

Figure 7-17 List of Available Exits for V4

- i) If necessary, turn either **FMS** Knob to select the desired exit. In this case Salina VOR (SLN) is selected as in Figure 7-17.

- j) Press the **ENT** Key. The selected airway and exit are displayed, and the prompt "LOAD?" highlighted as in Figure 7-18.

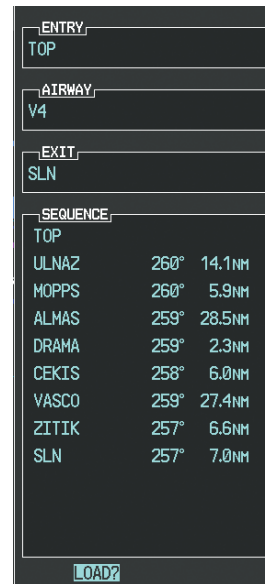

Figure 7-18 Ready to Load V4

- k) Press the **ENT** Key.

- l) V4 is now loaded into the flight plan as shown in Figure 7-19.

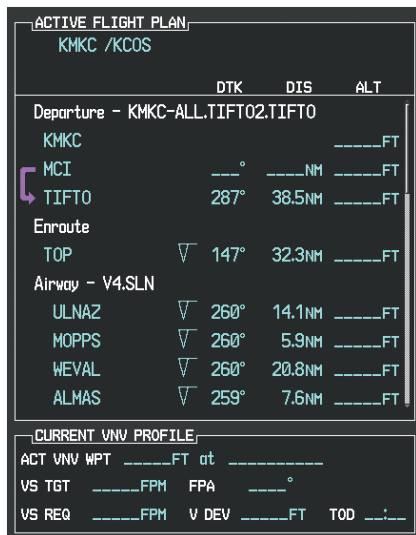

Figure 7-19 V4 is Loaded in the Flight Plan

- 5) Making V4 the active leg of the flight plan.
- Press the **FMS** Knob to activate the cursor.
 - Turn the large **FMS** Knob to highlight ULNAZ. The TO waypoint of the leg is selected in order to activate the leg.
 - Press the **ACT LEG** Softkey. The confirmation window is now displayed as in Figure 7-20. Note the TOP to ULNAZ leg is actually part of V4.

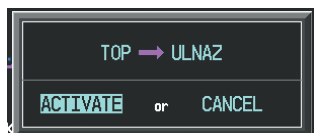

Figure 7-20 Confirm Active Leg

- d) Verify the displayed leg is the desired leg and press the **ENT** Key. Note in Figure 7-21, the magenta arrow in the flight plan window and magenta line on the map indicating V4 is now the active flight plan leg. Note the phase of flight remained in Terminal (TERM) mode up to this point because a departure leg was active. Since a leg after the departure is now active, the current CDI flight phase is ENR (Enroute) and CDI scaling has changed to 2.0 nm.



Figure 7-21 V4 Now Active Leg

- 6) The aircraft continues on heading 290°. When crosstrack distance is less than 2.0 nm, the XTK disappears from the HSI and the CDI is positioned on the last dot indicating a 2.0 nm distance from the centerline of the next course.
- 7) As the CDI approaches center, the aircraft turns onto the active leg as seen in Figure 7-22.



Figure 7-22 Turn on to Active Leg

- 8) At SLN, Victor Airway 244 (V244) is intercepted. Turn prompts are displayed in the PFD Navigation Status Box as seen in Figure 7-23.



Figure 7-23 Turn to Intercept V244

- 9) As seen in Figure 7-24, V244 is now the active flight plan leg.



Figure 7-24 V244 Now Active Leg

- 10) At Lamar VOR (LAA) V263 is intercepted. See Figure 7-25.



Figure 7-25 HYS to LAA Leg Active

- 11) ATC grants clearance to proceed direct to the OPSHN intersection to begin the arrival procedure. ATC advises to expect an altitude of 10,000 feet at OPSHN.

- Press the **FMS Knob** to activate the cursor.
- Turn the large **FMS Knob** to select OPSHN in the flight plan list.
- Press the **Direct-to** (**D**➔) Key. The Direct-to Window is now displayed as shown in Figure 7-26.



Figure 7-26 Direct To OPSHN

- d) Turn the large **FMS** Knob to place the cursor in the VNV altitude field as shown in Figure 7-27.



Figure 7-27 Enter VNV Altitude

- e) An altitude of 10,000 feet is entered as requested by ATC.

- f) Press the **ENT** Key. The cursor is now displayed in the VNV offset field as shown in Figure 7-28.



Figure 7-28 Enter VNV Offset Distance

- g) Enter the offset, or distance from the waypoint at which to reach the selected altitude. In this case, three miles prior to OPSHN is entered. In other words, the G1000 gives vertical guidance so the aircraft arrives at an altitude of 10,000 feet three miles prior to OPSHN.

h) Press the **ENT** Key twice to activate the direct-to. Note, in Figure 7-29, the magenta arrow indicating the direct-to OPSHN after the offset waypoint for OPSHN. The preceding offset waypoint indicates the offset distance and altitude that were previously entered. The remaining waypoints in the loaded arrival procedure have no database specified altitudes, therefore, dashes are displayed. Keep the CDI centered and maintain a track along the magenta line to OPSHN.

Note the Direct-to waypoint is within the loaded arrival procedure, therefore, phase of flight scaling for the CDI changes to Terminal Mode and is annunciated by displaying 'TERM' on the HSI.

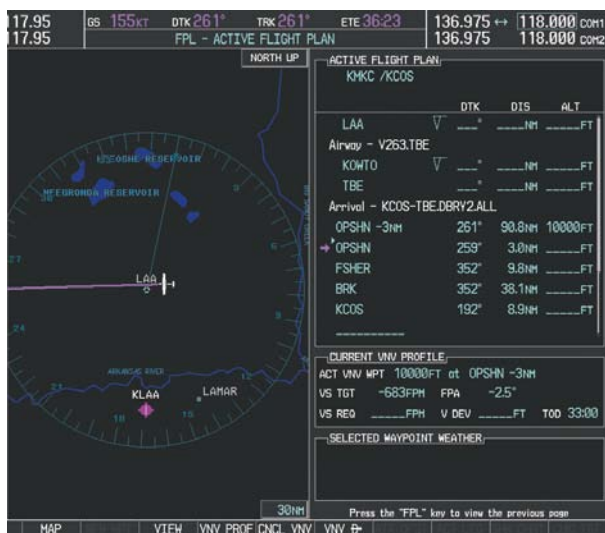

Figure 7-29 Direct-to Active

12) The aircraft is proceeding to OPSHN. The expected approach is the RNAV LPV approach to runway 35R, so it is selected.

- a) Press the **PROC** Key to display the Procedures Window.
- b) 'SELECT APPROACH' should be highlighted as shown in Figure 7-30.

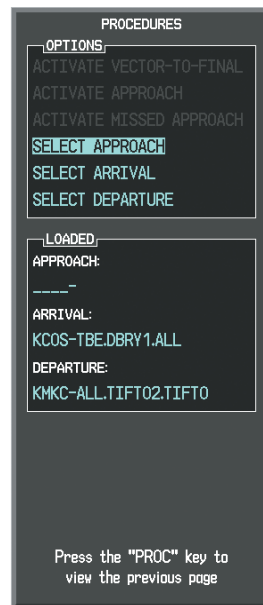

Figure 7-30 Procedures Window

- c) Press the **ENT** Key. A list of available approaches for the destination airport is displayed as in Figure 7-31.

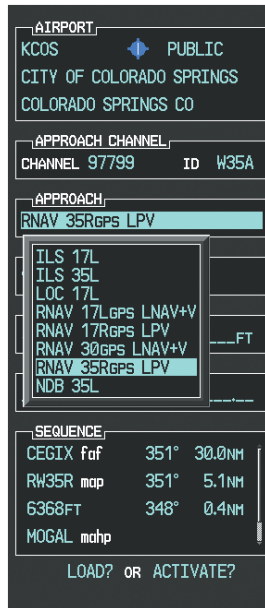

Figure 7-31 List of Available Approaches

- d) Turn either **FMS** Knob to select the LPV approach for 35R as shown in Figure 7-31.

- e) Press the **ENT** Key. A list of available transitions for the selected approach is displayed as in Figure 7-32.

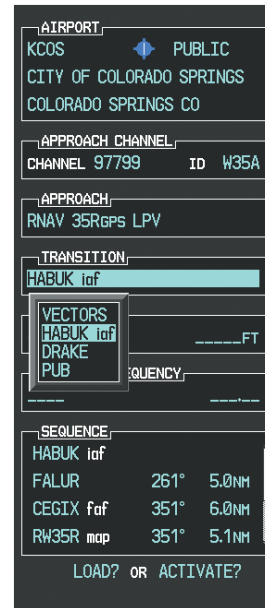

Figure 7-32 List of Available Transitions

- f) Turn either **FMS** Knob to select the desired transition. In this case, the Initial Approach Fix (IAF) at HABUK is used.
- g) Press the **ENT** Key.

h) Barometric Minimums

To set 'MINIMUMS', turn the small **FMS** Knob to select 'BARO', and press the **ENT** Key. Turn the small **FMS** Knob to select the altitude, and press the **ENT** Key.

Or:

To skip setting minimums, press the **ENT** Key.



Figure 7-33 Barometric Minimums Set

i) With 'LOAD?' highlighted, again press the **ENT** Key. The selected approach is added to the flight plan as seen in Figure 7-34.

Figure 7-34 Loaded Approach

- 13) Note the altitude constraints associated with each of the approach waypoints as seen in Figure 7-35. These altitudes are loaded from the database and are displayed as light blue text, indicating these values are "designated" for use in computing vertical deviation guidance.

To no longer use the displayed altitude for calculating vertical deviation guidance, perform the following:

- Press the **FMS** Knob to activate the cursor.
- Turn the small **FMS** Knob to highlight the desired altitude.
- Press the **CLR** Key.
- Press the **FMS** Knob to deactivate the cursor.

After making the altitude "non-designated", it is displayed as white text.

Altitude constraint values associated with the Final Approach Fix (FAF) and waypoints beyond the FAF cannot be designated for vertical guidance. These altitude values are always displayed as white text, as in Figure 7-35. Vertical guidance from the FAF and on to the Missed Approach Point (MAP) is given using the SBAS GPS altitude source, therefore, the displayed altitude values are for reference only.

ACTIVE FLIGHT PLAN			
KMKC /KCOS			
	DTK	DIS	ALT
OPSHN -3NM	___°	___NM	___FT
OPSHN	___°	___NM	___FT
FSHER	___°	___NM	___FT
PYNON	___°	___NM	___FT
Approach - KCOS-RNAV 35Rgps LPV			
HABUK iaf	021°	3.8NM	9000FT
FALUR	261°	5.0NM	8600FT
CEGIX faf	351°	6.0NM	7800FT
RW35R map	351°	5.1NM	
6368FT	348°	0.4NM	6370FT
MOGAL mahp			10000FT

CURRENT VNV PROFILE			
ACT VNV WPT	9000FT	at	HABUK iaf
VS TGT	-665FPM	FPA	-2.5°
VS REQ	-701FPM	V DEV	40FT BOD 01:09

Figure 7-35 Vertical Guidance is Active to the FAF

- 14) As the aircraft approaches OPSHN, it may be desirable to adjust the speed, or steepness of the upcoming descent. The default Flight Path Angle (FPA) is -3.0 degrees and a required vertical speed is computed to maintain the -3.0 FPA. To change the vertical flight path, perform the following steps.
- Press the **VNV PROF** Softkey to place the cursor in the target vertical speed field (VS TGT) as shown in Figure 7-36.

- At this point, the descent vertical speed can be selected, or the FPA can be selected. Turn the large **FMS** Knob to select the desired selection field, then turn the small **FMS** Knob to enter the desired value.

Note the information now displayed in the 'CURRENT VNV PROFILE' box. Also, note the offset waypoint (orange box) and gray circle are now displayed on the map. The gray circle marks the Top of Descent (TOD). In this example, vertical guidance is provided at the TOD that results in a -3.0 degree FPA descent to an altitude of 10,000 feet upon reaching the offset waypoint.

ACTIVE FLIGHT PLAN			
KMKC /KCOS			
	DTK	DIS	ALT
Airway - V263.TBE			
KOZTO	___°	___NM	___FT
TBE	___°	___NM	___FT
Arrival - KCOS-TBE.DBRV2.ALL			
OPSHN -3NM	260°	31.7NM	10000FT
OPSHN	259°	3.0NM	10000FT
FSHER	352°	9.8NM	10000FT
BRK	352°	38.1NM	10000FT
Approach - KCOS-RNAV 35R Ygps LNAV			
HABUK iaf	165°	22.7NM	9300FT
FALUR	262°	5.0NM	8100FT

CURRENT VNV PROFILE			
ACT VNV WPT	10000FT	at	OPSHN -3NM
VS TGT	-824FPM	FPA	-3.0°
VS REQ	___FPM	V DEV	___FT TOD 10:00

Figure 7-36 Adjusting the Descent

- Press the **ENT** Key.

- 15) As seen in Figure 7-37, the aircraft is approaching TOD. Note the target vertical speed required to reach the selected altitude. The Vertical Deviation Indicator (VDI) and the Required Vertical Speed Indicator (RVSI) are now displayed on the PFD as shown in Figure 7-38. When the aircraft is within one minute of the TOD, it is annunciated as shown in Figure 7-38, and an aural alert 'Vertical track' will be heard.

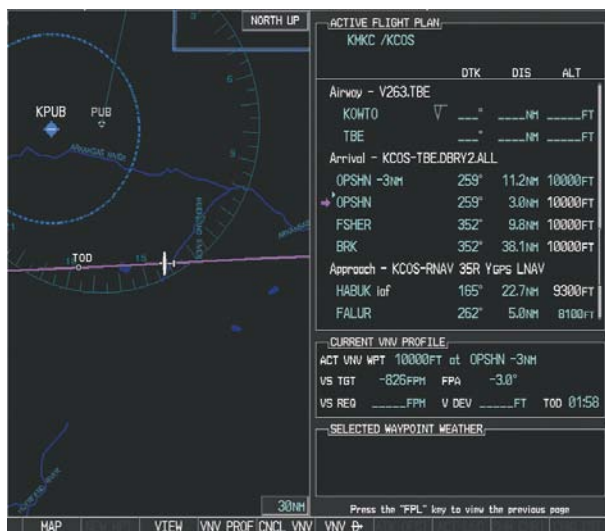

Figure 7-37 Approaching Top of Descent (TOD)

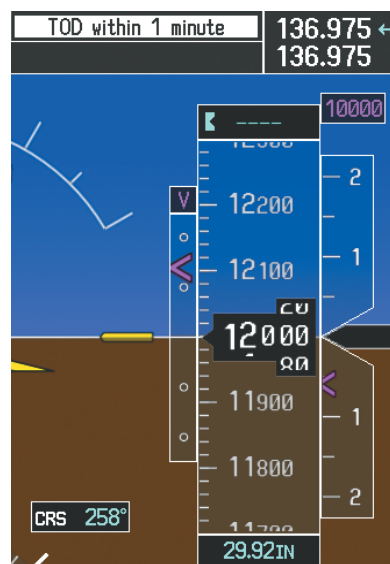

Figure 7-38 VDI & RVSI Upon Reaching Top of Descent (TOD)

- 16) Upon reaching TOD, a descent vertical speed is established by placing the VSI pointer in line with the RVSI as shown in Figure 7-39.

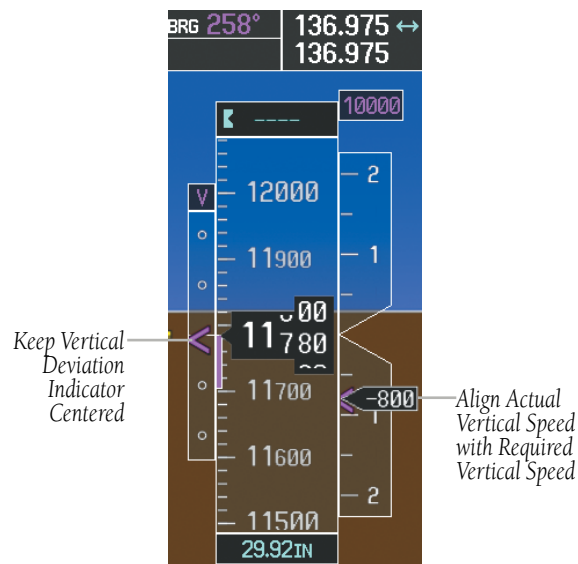

Figure 7-39 VDI & RVSI Showing Correctly Established Descent

- 17) When the aircraft is one minute from the bottom of descent (BOD) it is annunciated as shown in Figure 7-40. Upon reaching the offset waypoint for OPSHN, the aircraft is at 10,000 feet.

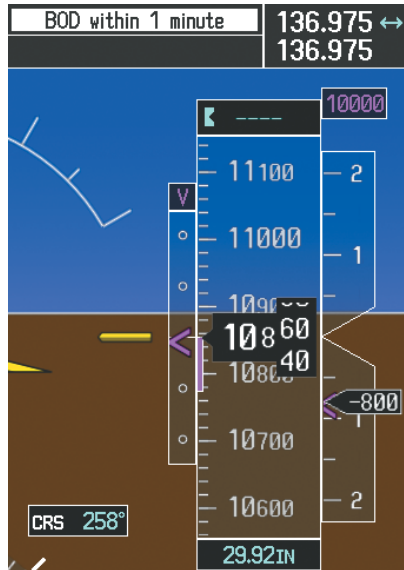

Figure 7-40 Approaching Bottom of Descent (BOD) at OPSHN Offset Waypoint

- 18) The aircraft is approaching OPSHN. The upcoming turn and next heading are annunciated at the top left of the PFD as seen in Figure 7-41. Initiate the turn and maneuver the aircraft on a track through the turn radius to intercept the magenta line for the OPSHN to FSHER leg and center the CDI.

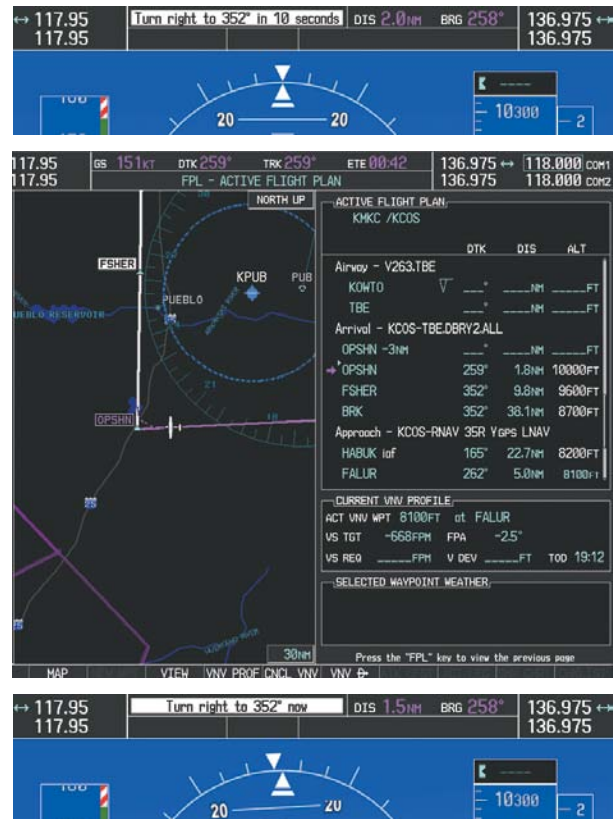

Figure 7-41 Turn to intercept OPSHN to FSHER Leg

- 19) After passing OPSHN, the next leg of the arrival turns magenta as shown in Figure 7-42. The magenta arrow in the flight plan list now indicates the OPSHN to FSHER leg of the arrival procedure is now active.



Figure 7-42 Tracking the OPSHN to FSHER Leg

- 20) The flight continues through the arrival procedure to PYNON (see Figure 7-43). At a point 31 nm from the destination airport, the phase of flight scaling for the CDI changes to Terminal Mode and is annunciated by displaying 'TERM' on the HSI.

A descent to HABUK is in the next leg. Note the TOD point on the map. Annunciations for the upcoming turn and descent, as well as the VDI and RVSI, appear on the PFD as the flight progresses.

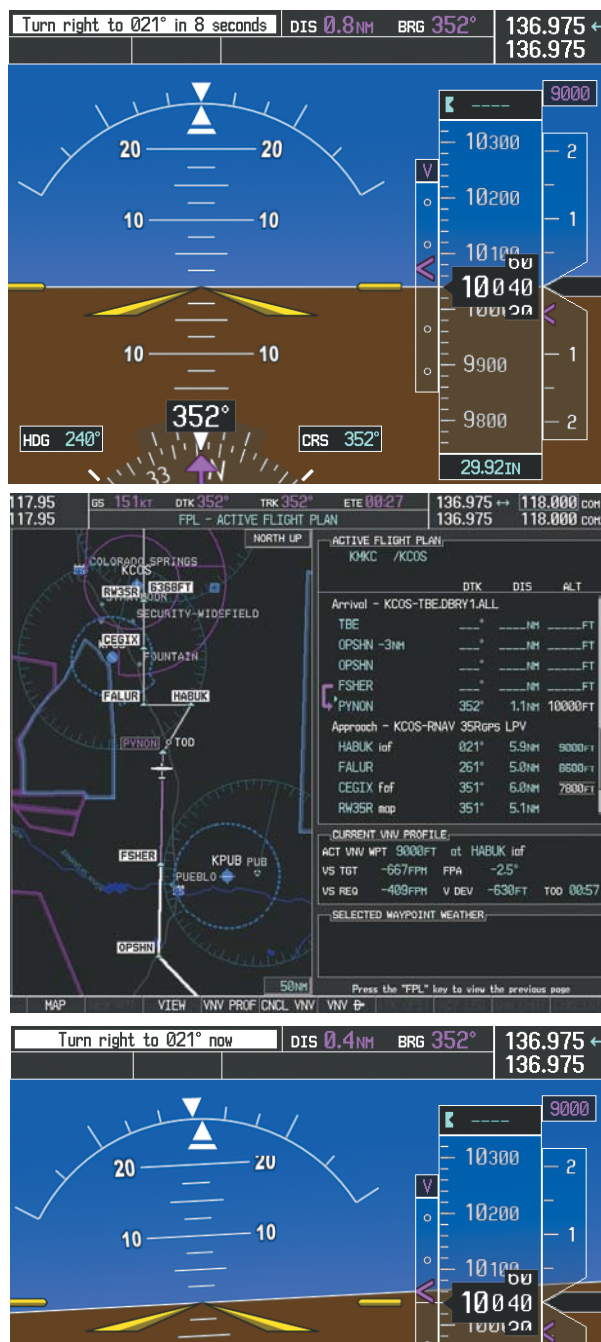

Figure 7-43 Approaching PYNON

- 21) Upon passing PYNON the approach procedure automatically becomes active. The approach may be activated at any point to proceed directly to the IAF. In this example, the aircraft has progressed through the final waypoint of the arrival and the flight plan has automatically sequenced to the IAF as the active leg, activating the approach procedure (see Figure 7-44).



Figure 7-44 Approach is Now Active

To manually activate the approach procedure, perform the following steps:

- Press the **PROC** Key.
- Turn the large **FMS** Knob to highlight 'ACTIVATE APPROACH' as shown in Figure 7-45.
- Press the **ENT** Key to activate the approach.

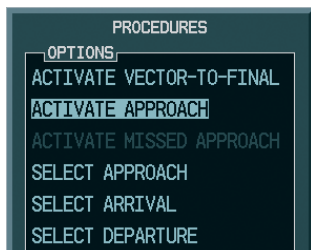

Figure 7-45 Manually Activate Approach

- 22) The IAF is the next waypoint. At the TOD, establish a descent vertical speed as previously discussed in Step 16. The aircraft altitude is 9,000 feet upon reaching HABUK.

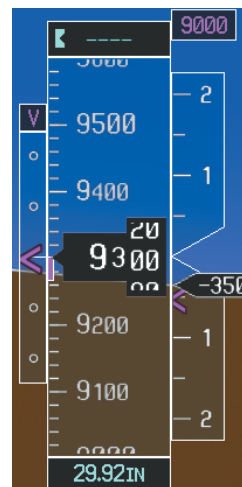

Figure 7-46 Descending Turn to the Initial Approach Fix (IAF)

- 23) After crossing FALUR the next waypoint is the FAF. The flight phase changes to LPV on the HSI indicating the current phase of flight is in Approach Mode and the approach type is LPV. CDI scaling changes accordingly and is used much like a localizer when flying an ILS approach. The RVSI is no longer displayed and the VDI changes to the Glidepath Indicator (as shown in Figure 7-47) when the final approach course becomes active.



Figure 7-47 Descending to the FAF

The descent continues through the FAF (CEGIX) using the Glidepath Indicator, as one would use a glideslope indicator, to obtain an altitude "AT" 7,800 feet at the FAF. Note the altitude restriction lines over and under (At) the altitude in the 'ALT' field in Figure 7-44.

- 24) After crossing CEGIX, the aircraft continues following the glidepath to maintain the descent to "AT or ABOVE" 6,370 feet at the Missed Approach Point (MAP) (RW35R) as seen in Figure 7-48.

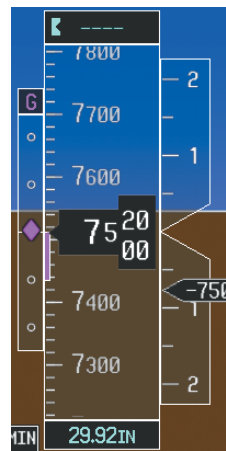

Figure 7-48 Descending to the Missed Approach Point

In this missed approach procedure, the altitude immediately following the MAP (in this case '6368ft') is not part of the published procedure. It is simply a Course to Altitude (CA) leg which guides the aircraft along the runway centerline until the altitude required to safely make the first turn toward the MAHP is exceeded. This altitude is provided by Jeppesen, and may be below, equal to, or above the published minimums for this approach. In this case, if the aircraft altitude is below the specified altitude (6,368 feet) after crossing the MAP, a direct-to is established to provide a course on runway heading until an altitude of 6,368 feet is reached. After reaching 6,368 feet, a direct-to is established to the published MAHP (in this case MOGAL). If the aircraft altitude is above the specified altitude after crossing the MAP, a direct-to is established to the published fix (MOGAL) to begin the missed approach procedure.

In some missed approach procedures this Course to Altitude leg may be part of the published procedure. For example, a procedure may dictate a climb to 5,500 feet, then turn left and proceed to the Missed Approach Hold Point (MAHP). In this case, the altitude would appear in the list of waypoints as '5500ft'. Again, if the aircraft altitude is lower than the prescribed altitude, a direct-to is established on a Course to Altitude leg when the missed approach procedure is activated.

- 25) Upon reaching the MAP, it is decided to execute a missed approach. Automatic waypoint sequencing is suspended past the MAP. Press the **SUSP** Softkey on the PFD to resume automatic waypoint sequencing through the missed approach procedure.

A direct-to is initiated to MOGAL, which is the Missed Approach Hold Point (MAHP) as seen in Figure 7-49. The aircraft is climbing to 10,000 feet. The CDI flight phase now changes from LPV to MAPR as seen on the HSI.

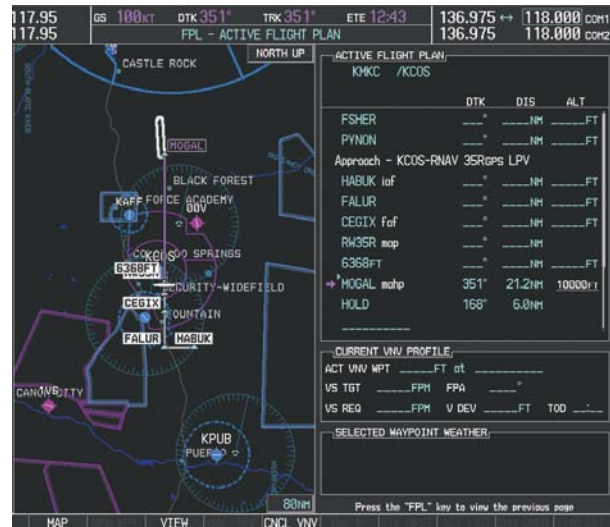

Figure 7-49 Missed Approach Active

26) The aircraft continues climbing to “AT or ABOVE” 10,000 feet at MOGAL. A holding pattern is established at the MAHP (MOGAL) as shown in Figure 7-50.



Figure 7-50 Establishing the Holding Pattern

27) The aircraft maintains 10,000 feet while following the magenta line through the hold as in Figure 7-51.

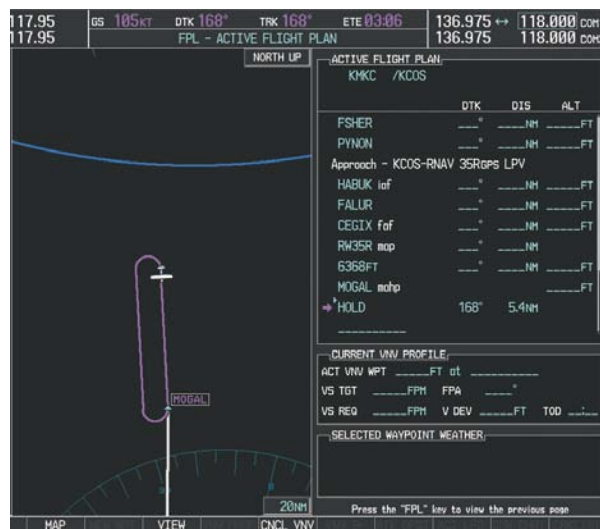

Figure 7-51 Hold Established

7.4 AIRPORT INFORMATION



Figure 7-52 Airport Information Page

Select the Airport Information Page

- 1) Turn the large **FMS** Knob to select the 'WPT' page group.
- 2) Turn the small **FMS** Knob to select the AIRPORT INFORMATION Page. Initially, information for the airport closest to the aircraft's present position is displayed.
- 3) If necessary, press the INFO softkey until **INFO-1** is displayed.

Access Runway Information

- 1) With the Airport Information Page displayed, press the **FMS** Knob to activate the cursor.
- 2) Turn the large **FMS** Knob to place the cursor on the 'RUNWAYS' identifier field.
- 3) Turn the small **FMS** Knob in the direction of the green arrow to display the next runway for the selected airport. Continue turning the small **FMS** Knob to select the desired runway.
- 4) To remove the flashing cursor, press the **FMS** Knob.

Access Frequency Information

- 1) With the Airport Information Page displayed, press the **FMS** Knob to activate the cursor.
- 2) Turn the large **FMS** Knob to move the cursor to the Frequencies box.
- 3) Turn either **FMS** Knob to scroll through the list, placing the cursor on the desired frequency. If a listed frequency has sector or altitude restrictions, the frequency is preceded by an info ('i') designation. Press the **ENT** Key to view the information. The following may be displayed with the frequency:
 - 'TX' – transmit only
 - 'RX' – receive only
 - 'PT' – part time frequency
- 4) Press the **ENT** Key to place the selected frequency in the standby field of the COM or NAV box.
- 5) To remove the cursor, press the **FMS** Knob.

Display AOPA Airport Directory Information

With the Airport Information Page displayed, press the INFO softkey until **INFO-2** is displayed. The Airport Directory Page is now displayed.

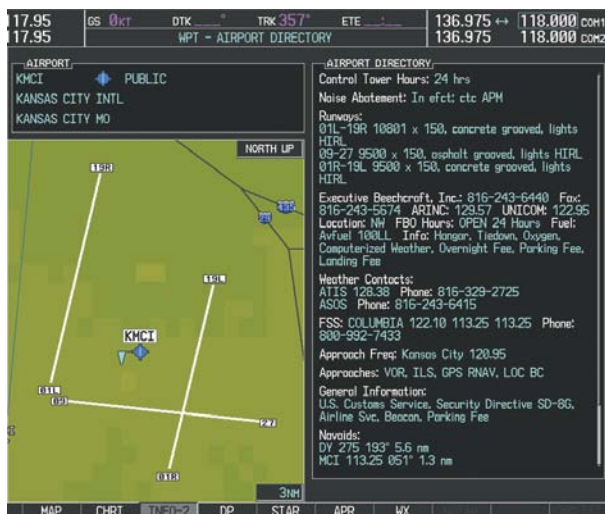

Figure 7-53 AOPA Airport Directory Information

Select an Airport from the Database

- 1) With the Airport Information Page displayed, press the **FMS** Knob to activate the cursor.
- 2) Enter the desired airport identifier.

Select an Airport from the Active Flight Plan

- 1) With the Airport Information Page displayed, press the **FMS** Knob to activate the cursor.
- 2) Turn the small **FMS** Knob to the left to display a list of flight plan airports as shown in Figure 7-54.



Figure 7-54 Flight Plan Airport List

- 3) Turn the large **FMS** Knob to select the desired airport.
- 4) Press the **ENT** Key.

Select a Nearest Airport

- 1) With the Airport Information Page displayed, press the **FMS** Knob to activate the cursor.
- 2) Turn the small **FMS** Knob to the left. Initially, a flight plan airport list is displayed as in Figure 7-54. The list is populated only when navigating a flight plan.



Figure 7-55 Nearest Airport List

- 3) Turn the small **FMS** Knob to the right to display the 'NRST' airports to the aircraft's current position as shown in Figure 7-55.
- 4) Turn the large **FMS** Knob to select the desired airport.
- 5) Press the **ENT** Key.

Select a Recently Entered Airport Identifier

- 1) With the Airport Information Page displayed, press the **FMS** Knob to activate the cursor.
- 2) Turn the small **FMS** Knob to the left. Initially, a flight plan waypoint list is displayed as in Figure 7-54. The list is populated only when navigating a flight plan.
- 3) Turn the small **FMS** Knob to the right to display the 'RECENT' airports as shown in Figure 7-56.



Figure 7-56 Recently Entered Airports List

- 4) Turn the large **FMS** Knob to select the desired airport.
- 5) Press the **ENT** Key.

Select an Airport by Facility Name or City Location

- 1) With the Airport Information Page displayed, press the **FMS** Knob to activate the cursor.
- 2) Turn the large **FMS** Knob to the right to select the facility name or location (city) field.
- 3) Enter the desired facility name or city.
- 5) Press the **ENT** Key. If there are duplicate names in the database, a list is displayed from which to choose the desired location.
- 6) To remove the flashing cursor, press the **FMS** Knob.

7.5 INTERSECTION INFORMATION

Select the Intersection Information Page

- 1) Turn the large **FMS** Knob to select the 'WPT' page group.
- 2) Turn the small **FMS** Knob to select INTERSECTION INFORMATION.



Figure 7-57 Intersection Information Page

Access Information on an Intersection

- 1) With the Intersection Information Page displayed, press the **FMS** Knob to activate the cursor.
- 2) Enter an intersection identifier and press the **ENT** Key.
- 3) Press the **FMS** Knob to remove the flashing cursor.

7.6 NDB INFORMATION



Figure 7-58 NDB Information Page

Select the NDB Information Page

- 1) Turn the large **FMS** Knob to select the 'WPT' page group.
- 2) Turn the small **FMS** Knob to select NDB INFORMATION.

View Information on a Specific NDB

- 1) With the NDB Information Page displayed, press the **FMS** Knob to activate the cursor.
- 2) Turn the large **FMS** Knob to highlight the desired selection field (identifier, name or closest city).
- 3) Enter an identifier, name or city and press the **ENT** Key.
- 4) Press the **FMS** Knob to remove the flashing cursor.

7.7 VOR INFORMATION

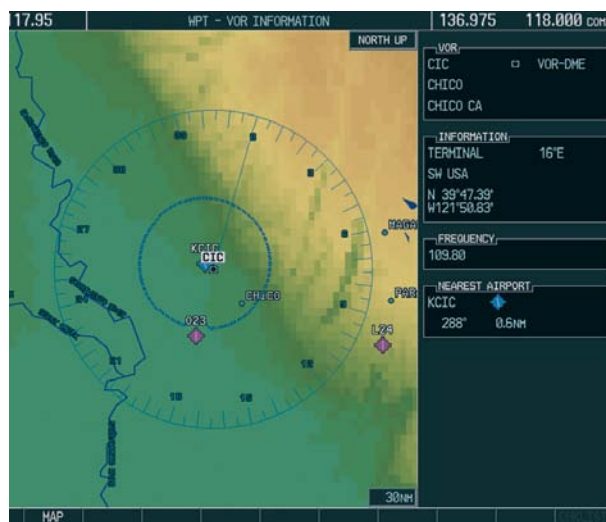

Figure 7-59 VOR Information Page

Select the VOR Information Page

- 1) Turn the large **FMS** Knob to select the 'WPT' page group.
- 2) Turn the small **FMS** Knob to select VOR INFORMATION.

Access Information on a VOR

- 1) With the VOR Information Page displayed, press the **FMS** Knob to activate the cursor.
- 2) Turn the large **FMS** Knob to highlight the desired selection field (identifier, name or closest city).
- 3) Enter an identifier, name or city and press the **ENT** Key.
- 4) The 'FREQUENCY' field is now highlighted. If desired, press the **ENT** Key to place the frequency in the NAV receiver standby field.
- 5) Press the **FMS** Knob to remove the flashing cursor.

7.8 USER WAYPOINT INFORMATION PAGE

See the Flight Planning section for a discussion on creating and modifying user defined waypoints.

7.9 NEAREST AIRPORTS



Figure 7-60 Nearest Airports Page

Nearest Airport Information on the MFD

Select the Nearest Airports Page

- 1) Turn the large **FMS** Knob to select the 'NRST' page group.
- 2) Turn the small **FMS** Knob to select NEAREST AIRPORTS.

Initially, the closest airport to the aircraft's present position is displayed.

Access Information on a Specific Airport

- 1) With the Nearest Airports Page displayed, press the **APT** Softkey to place the cursor in the 'NEAREST AIRPORTS' field. The first airport in the nearest airports list is highlighted.
- 2) Turn either **FMS** Knob to highlight the desired airport.
- 3) Press the **FMS** Knob to remove the flashing cursor.

Access Runway Information for the Selected Airport

- 1) With the Nearest Airports Page displayed, press the **RNWW** Softkey to place the cursor in the 'RUNWAYS' field.
- 2) Turn the small **FMS** Knob to select the desired runway.
- 3) Press the **FMS** Knob to remove the flashing cursor.

Quickly Tune the COM Transceiver to a Nearby Airport Frequency

- 1) With the Nearest Airports Page displayed, press the **FREQ** Softkey to place the cursor in the 'FREQUENCIES' field.
- 2) Turn either **FMS** Knob to select the desired frequency.
- 3) Press the **ENT** Key. The selected frequency is placed in the COM standby frequency field.
- 4) Press the **Frequency Transfer** Key to place the frequency in the active field.
- 5) Press the **FMS** Knob to remove the flashing cursor.

Nearest Airports Information on the PFD

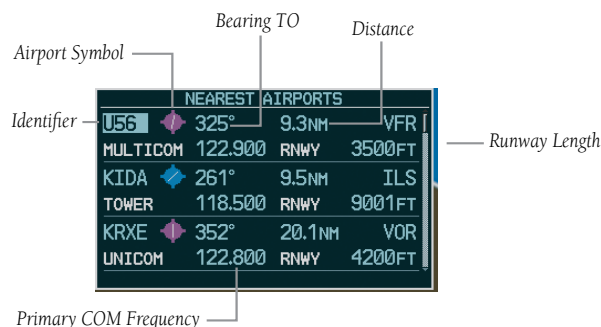

Figure 7-61 Nearest Airports Window

Press the **NRST** Softkey to display the PFD Nearest Airports Window.

View Information on a Specific Airport in the List

- 1) With the Nearest Airports Window displayed, turn either **FMS** Knob to place the cursor on the desired airport identifier.
- 2) Press the **ENT** Key to display airport information.
- 3) Press the **ENT** Key again (cursor is on 'BACK') to return to the list.

Load an Airport COM Frequency into the Active COM

- 1) With the Nearest Airports Window displayed, turn either **FMS** Knob to place the cursor on the desired airport frequency shown in the window.
- 2) Press the **ENT** Key and the selected frequency is placed in the COM standby frequency field.
- 3) Press the **Frequency Transfer** Key to make the frequency the active frequency.

7.10 NEAREST INTERSECTIONS



Figure 7-62 Nearest Intersections Page

Select the Nearest Intersections Page

- 1) Turn the large **FMS** Knob to select the 'NRST' page group.
- 2) Turn the small **FMS** Knob to select NEAREST INTERSECTIONS.

View Information on the Nearest Intersection

- 1) With the Nearest Intersections Page displayed, press the **FMS** Knob to activate the cursor.
- 2) Turn either **FMS** Knob to select the desired intersection.
- 3) Press the **FMS** Knob to remove the flashing cursor.

7.11 NEAREST NDB



Figure 7-63 Nearest NDB Page

Select the Nearest NDB Page

- 1) Turn the large **FMS** Knob to select the 'NRST' page group.
- 2) Turn the small **FMS** Knob to select NEAREST NDB.

Access Information on a Specific NDB

- 1) With the Nearest NDB Page displayed, press the **FMS** Knob to activate the cursor.
- 2) Turn either **FMS** Knob to select the desired NDB. The remaining information on the Nearest NDB Page pertains to the selected NDB.
- 3) Press the **FMS** Knob to remove the flashing cursor.

7.12 NEAREST VOR



Figure 7-64 Nearest VOR Page

Select the Nearest VOR Page

- 1) Turn the large **FMS** Knob to select the 'NRST' page group.
- 2) Turn the small **FMS** Knob to select NEAREST VOR.

View Information on the Nearest VOR

- 1) With the Nearest VOR Page displayed, press the **VOR** Softkey to place the cursor in the 'NEAREST VOR' box.
- 2) Turn either **FMS** Knob to select a VOR.
- 3) Press the **FMS** Knob to remove the flashing cursor.

Select and Load a VOR Frequency

- 1) With the Nearest VOR Page displayed, press the **FREQ** Softkey to highlight the VOR frequency in the 'FREQUENCY' field.

- 2) Press the **ENT** Key. The selected VOR frequency is placed in the NAV standby frequency field.
- 3) Press the **FMS** Knob to remove the flashing cursor.

Waypoint Page pertains to the selected Nearest User Waypoint.

- 3) Press the **FMS** Knob to remove the flashing cursor.

7.13 NEAREST USER WAYPOINT



Figure 7-65 Nearest User Waypoints Page

Select the Nearest User Waypoint Page

- 1) Turn the large **FMS** Knob to select the 'NRST' page group.
- 2) Turn the small **FMS** Knob to select NEAREST USER WAYPOINT.

Select a Nearest User Waypoint

- 1) With the Nearest User Waypoint Page displayed, press the **FMS** Knob to activate the cursor. If any previously entered User Waypoints are within 200 nm, they are displayed with the closest listed first.
- 2) Turn either **FMS** Knob to select the desired waypoint. The remaining information on the Nearest User

7.14 NEAREST FREQUENCIES



Figure 7-66 Nearest Frequencies Page

Select the Nearest Frequencies Page

- 1) Turn the large **FMS** Knob to select the 'NRST' page group.
- 2) Turn the small **FMS** Knob to select NEAREST FREQUENCIES.

Select and Load the Nearest ARTCC, FSS, or Weather Frequency

- 1) With the Nearest Frequencies Page displayed, press the **ARTCC**, **FSS**, or **WX** Softkey to place the cursor in the appropriate field.
- 2) Turn the **FMS** Knobs to select the desired facility or frequency.

- 3) Press the **ENT** Key to load the frequency into the COM frequency standby field.
- 4) Press the **FMS** Knob to remove the flashing cursor.

7.15 NEAREST AIRSPACES



Figure 7-67 Nearest Airspaces Page

Select the Nearest Airspaces Page

- 1) Turn the large **FMS** Knob to select the 'NRST' page group.
- 2) Turn the small **FMS** Knob to select NEAREST AIRSPACES.

Airspace Alerts Box

- If the projected course takes the aircraft inside an airspace within the next ten minutes, 'Ahead' is displayed.
- If the aircraft is within two nautical miles of an airspace and the current course takes the aircraft inside, 'Ahead < 2 nm' is displayed.

- If the aircraft is within two nautical miles of an airspace and the current course will not take the aircraft inside, 'Within 2 nm' is displayed.
- If the aircraft has entered an airspace, 'Inside' is displayed.

View Additional Details for a Listed Airspace

- 1) With the Nearest Airspace Page displayed, press the **FMS** Knob to activate the cursor.
- 2) Turn the large **FMS** Knob to scroll through the list, highlighting the desired airspace.
- 3) Press the **ALERTS** Softkey to place the cursor in the 'AIRSPACE ALERTS' field.
- 4) Turn either **FMS** Knob to select the desired airspace.
- 5) Press the **FMS** Knob to remove the flashing cursor.

View and Quickly Load the Frequency for a Controlling Agency

- 1) With the Nearest Airspace Page displayed, press the **FREQ** Softkey to place the cursor in 'FREQUENCIES' field.
- 2) Turn either **FMS** Knob to select the desired frequency.
- 3) Press the **ENT** Key to load the frequency into the COM frequency standby field.
- 4) Press the **FMS** Knob to remove the flashing cursor.



Blank Page

SECTION 8: FLIGHT PLANNING

The following discussions pertain to the Multi Function Display, unless otherwise indicated.

8.1 USER DEFINED WAYPOINTS



Figure 8-1 User WPT Information Page

Select the User WPT Information Page

- 1) Turn the large **FMS** Knob to select the 'WPT' page group.
- 2) Turn the small **FMS** Knob to select USER DEFINED WAYPOINTS.

Create a User Waypoint Defined by Latitude & Longitude

- 1) With the User Defined Waypoint Page displayed, press the **NEW** Softkey. A waypoint is created at the current aircraft position.
- 2) Enter the desired waypoint name.
- 3) Press the **ENT** Key.
- 4) The cursor is now in the 'WAYPOINT TYPE' field. If desired, the waypoint can be made temporary

(deleted automatically when the system is turned off). If the waypoint is to remain in the system, proceed to step 7.

- a) Turn the large **FMS** Knob one click to the left to highlight 'TEMPORARY'.
 - b) Press the **ENT** Key to place a check-mark in the box. Turn the large **FMS** Knob to place the cursor back in the 'WAYPOINT TYPE' field.
- 5) With the cursor in the 'WAYPOINT TYPE' field, turn the small **FMS** Knob to display a list of waypoint types.
 - 6) Turn the small **FMS** Knob to select LAT/LON (latitude and longitude).
 - 7) Press the **ENT** Key.

Create a User Waypoint Defined by Radials from Other Waypoints

- 1) With the User Defined Waypoint Page displayed, press the **NEW** Softkey. A waypoint is created at the current aircraft position.
- 2) Enter the desired waypoint name.
- 3) Press the **ENT** Key.
- 4) The cursor is now in the 'WAYPOINT TYPE' field. If desired, the waypoint can be made temporary (deleted automatically when the system is turned off). If the waypoint is to remain in the system, proceed to step 7.
 - a) Turn the large **FMS** Knob one click to the left to highlight 'TEMPORARY'.
 - b) Press the **ENT** Key to place a check-mark in the box. Turn the large **FMS** Knob to place the cursor back in the 'WAYPOINT TYPE' field.
- 5) With the cursor in the 'WAYPOINT TYPE' field, turn the small **FMS** Knob to display a list of waypoint types.

- 6) Turn the small **FMS** Knob to select RAD/RAD (radial/radial).
- 7) Press the **ENT** Key.
- 8) The cursor moves to the 'REFERENCE WAYPOINTS' field. With the first waypoint name highlighted, use the **FMS** Knobs to enter the desired waypoint name. Waypoints may also be selected as follows:
 - a) When a flight plan is active, turning the small **FMS** Knob to the left will display a list of the flight plan waypoints.
 - b) Turn the large **FMS** Knob to select the desired waypoint.
 - c) Press the **ENT** Key.

Or:

 - a) Turn the small **FMS** Knob to the left. Initially, a flight plan waypoint list is displayed.
 - b) Turn the small **FMS** Knob to the right to display the 'NRST' airports to the aircraft's current position.
 - c) Turn the large **FMS** Knob to select the desired waypoint.
 - d) Press the **ENT** Key.

Or:

 - a) Turn the small **FMS** Knob to the left. Initially, a flight plan waypoint list is displayed.
 - b) Turn the small **FMS** Knob to the right to display the 'RECENT' waypoints.
 - c) Turn the large **FMS** Knob to select the desired waypoint.
 - d) Press the **ENT** Key.

Or:

 - a) Turn the small **FMS** Knob to the left. Initially, a flight plan waypoint list is displayed.
 - b) Turn the small **FMS** Knob to the right to display the 'USER' waypoints.
- c) Turn the large **FMS** Knob to select the desired waypoint.
- d) Press the **ENT** Key.
- 9) Press the **ENT** Key. The cursor is displayed in the 'RAD' (radial) field. Enter the desired radial from the reference waypoint.
- 10) Press the **ENT** Key.
- 11) Repeat step 10 to enter the next waypoint name.
- 12) Press the **ENT** Key. The cursor is displayed in the 'RAD' (radial) field for the second waypoint. Enter the desired radial from the reference waypoint.
- 13) Press the **ENT** Key.
- 14) Press the **FMS** Knob to remove the flashing cursor.

Create a User Waypoint Defined by a Radial & Distance from Another Waypoint

- 1) With the User Defined Waypoint Page displayed, press the **NEW** Softkey. A waypoint is created at the current aircraft position.
- 2) Enter the desired waypoint name.
- 3) Press the **ENT** Key.
- 4) The cursor is now in the 'WAYPOINT TYPE' field. If desired, the waypoint can be made temporary (deleted automatically when the system is turned off). If the waypoint is to remain in the system, proceed to step 7.
 - a) Turn the large **FMS** Knob one click to the left to highlight 'TEMPORARY'.
 - b) Press the **ENT** Key to place a check-mark in the box. Turn the large **FMS** Knob to place the cursor back in the 'WAYPOINT TYPE' field.
- 5) With the cursor in the 'WAYPOINT TYPE' field, turn the small **FMS** Knob to display a list of waypoint types.

- 6) Turn the small **FMS** Knob to select RAD/DIS (radial/distance).
- 7) Press the **ENT** Key.
- 8) The cursor moves to the 'REFERENCE WAYPOINTS' field. With the first waypoint name highlighted, use the **FMS** Knobs to enter the desired waypoint name. Waypoints may also be selected as follows:
 - a) When a flight plan is active, turning the small **FMS** Knob to the left will display a list of the flight plan waypoints.
 - b) Turn the large **FMS** Knob to select the desired waypoint.
 - c) Press the **ENT** Key.

Or:

- a) Turn the small **FMS** Knob to the left. Initially, a flight plan waypoint list is displayed.
- b) Turn the small **FMS** Knob to the right to display the 'NRST' airports to the aircraft's current position.
- c) Turn the large **FMS** Knob to select the desired waypoint.
- d) Press the **ENT** Key.

Or:

- a) Turn the small **FMS** Knob to the left. Initially, a flight plan waypoint list is displayed.
- b) Turn the small **FMS** Knob to the right to display the 'RECENT' waypoints.
- c) Turn the large **FMS** Knob to select the desired waypoint.
- d) Press the **ENT** Key.

Or:

- a) Turn the small **FMS** Knob to the left. Initially, a flight plan waypoint list is displayed.
- b) Turn the small **FMS** Knob to the right to display the 'USER' waypoints.

c) Turn the large **FMS** Knob to select the desired waypoint.

d) Press the **ENT** Key.

9) Press the **ENT** Key. The cursor is displayed in the 'RAD' (radial) field. Enter the desired radial from the reference waypoint.

10) Press the **ENT** Key.

11) The cursor is now displayed in the 'DIS' (distance) field. Enter the desired distance from the reference waypoint.

12) Press the **ENT** Key.

13) Press the **FMS** Knob to remove the flashing cursor.

Create a User Waypoint using the Map Pointer

- 1) Press the **Joystick** to activate the panning function and pan to the map location of the desired user waypoint.
- 2) Press the **ENT** Key. The User Waypoint Information Page is displayed with the captured position.



NOTE: If the pointer has highlighted a map database feature, one of three things happens upon pressing the **ENT** Key: 1) information about the selected feature is displayed instead of initiating a new waypoint, 2) a menu pops up allowing a choice between 'Review Airspaces' or 'Create User Waypoint', or 3) a new waypoint is initiated with the default name being the selected map item.

- 3) Enter a user waypoint name (up to six characters).
- 4) Press the **ENT** Key to accept the selected name.
- 5) If desired, define the type and location (i.e., LAT/LON, RAD/RAD or RAD/DIS) of the waypoint.
- 6) Press the **ENT** Key to accept the new waypoint.

- 7) If desired, change the storage method of the waypoint to “TEMPORARY” or “NORMAL” by moving the cursor to “TEMPORARY” and selecting the **ENT** Key to check or uncheck the box.
- 8) Press the **FMS** Knob to remove the flashing cursor.
- 9) Press the **GO BACK** Softkey to return to the map page.

Delete a User Waypoint

- 1) With the User Defined Waypoint Page displayed, press the **FMS** Knob to activate the cursor.
- 2) Turn the large **FMS** Knob to the place the cursor in the ‘USER WAYPOINT LIST’ field.
- 3) Turn the small **FMS** Knob to highlight the desired waypoint.
- 4) Press the **DELETE** Softkey.
- 5) The message ‘Would you like to delete the user waypoint?’ is displayed. With ‘YES’ highlighted, press the **ENT** Key.



NOTE: The option to ‘Delete All User Waypoints’ is not available while the aircraft is in flight.

8.2 VIEWING THE ACTIVE FLIGHT PLAN

Press the **FPL** Key.



Figure 8-2 Active Flight Plan Window on the PFD

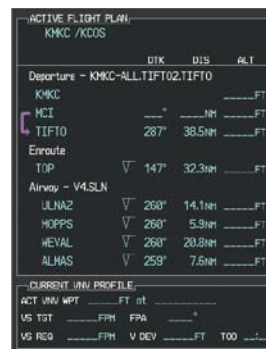

Figure 8-3 Active Flight Plan Page on the MFD

8.3 ACTIVATE A STORED FLIGHT PLAN

- 1) Press the **FPL** Key and turn the small **FMS** Knob to display the Flight Plan Catalog Page.

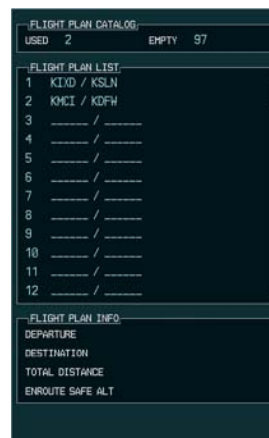

Figure 8-4 Flight Plan Catalog Page

- 2) Press the **FMS** Knob to activate the cursor.
- 3) Turn the large **FMS** Knob to highlight the desired flight plan and press the **ACTIVE** Softkey.
- 4) With ‘OK’ highlighted, press the **ENT** Key to activate the flight plan. To cancel the flight plan activation, turn the large **FMS** Knob to highlight ‘CANCEL’ and press the **ENT** Key.

8.4 ACTIVATE A FLIGHT PLAN LEG

- 1) From the Active Flight Plan Page, press the **FMS** Knob to activate the cursor and turn the large **FMS** Knob to highlight the desired destination waypoint.
- 2) Press the **ACT LEG** Softkey (using MFD only).
Or:

Press the **MENU** Key, select the 'Activate Leg' option from the page menu and press the **ENT** Key. This step must be used when activating a leg from the PFD.

- 3) With 'Activate' highlighted, press the **ENT** Key.

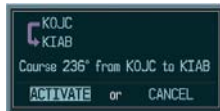

Figure 8-5 Activate Flight Plan Leg Confirmation

8.5 STOP NAVIGATING A FLIGHT PLAN

- 1) Press the **FPL** Key to display the Active Flight Plan Page.
- 2) Press the **MENU** Key to display the Page Menu window.

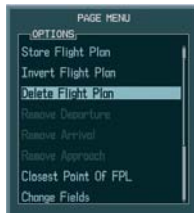

Figure 8-6 Delete Flight Plan

- 3) Turn the large **FMS** Knob to highlight 'Delete Flight Plan' and press the **ENT** Key. With 'OK' highlighted, press the **ENT** Key to deactivate the flight plan. This will not delete the stored flight plan, only the active flight plan.

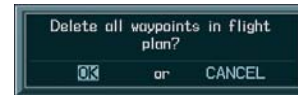

Figure 8-7 Delete Flight Plan Confirmation

8.6 INVERT ACTIVE FLIGHT PLAN

- 1) From the Active Flight Plan Page, press the **MENU** Key to display the Page Menu.
- 2) Turn the large **FMS** Knob to highlight 'Invert Flight Plan' and press the **ENT** Key. The original flight plan remains intact in its flight plan catalog storage location.
- 3) With 'OK' highlighted, press the **ENT** Key to invert the flight plan.

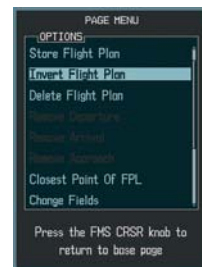

Figure 8-8 Invert Flight Plan

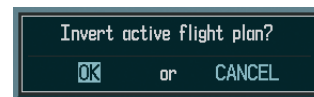

Figure 8-9 Invert Flight Plan Confirmation

8.7 CREATE A FLIGHT PLAN

Create a Flight Plan Using the MFD

- 1) Press the **FPL** Key and turn the small **FMS** Knob to display the Flight Plan Catalog Page.

- 2) Press the **NEW** Softkey to display a blank flight plan page for the first empty storage location.

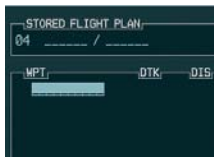

Figure 8-10 Create FPL on MFD

- 3) Turn the small **FMS** Knob to display the Waypoint Information Window.
- 4) Turn the small **FMS** Knob to the right enter the first character of the identifier of the departure waypoint. Turning the knob to the left accesses the FPL, NRST, and RECENT waypoint list.
- 5) Turn the large **FMS** Knob to move the cursor to the next character field. Repeat steps 4 and 5 until the desired identifier has been entered.



Figure 8-11 Waypoint Info Window

- 6) Press the **ENT** Key.
- 7) Repeat step number 3, 4, and 5 to enter the identifier for each additional flight plan waypoint.
- 8) When all waypoints have been entered, press the **FMS** Knob to return to the Flight Plan Catalog Page. The new flight plan is now in the list.

Create a Flight Plan Using the PFD



NOTE: A flight plan cannot be entered using the PFD if another flight plan is active.



NOTE: After the first leg is entered (using the PFD only), it is immediately activated.

- 1) Press the **FPL** Key, then press the **FMS** Knob to activate the cursor.
- 2) Turn the small **FMS** Knob to enter the first letter of the destination waypoint identifier. Turn the large **FMS** Knob to the right to move the cursor to the next character position.
- 3) Repeat step 2 to spell out the rest of the waypoint identifier.
- 4) Press the **ENT** Key and the cursor is now ready for entering of the next flight plan waypoint.
- 5) Repeat steps 2 through 4 to enter the identifier for each additional flight plan waypoint.
- 6) Once all waypoints have been entered, press the **FMS** Knob remove the cursor. The new flight plan is now active.

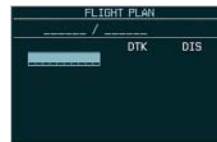

Figure 8-12 Creating Flight Plan on the PFD

8.8 IMPORT A FLIGHT PLAN FROM AN SD CARD

- 1) Insert the SD card containing the flight plan in the top card slot on the MFD.
- 2) Press the **FPL** Key on the Control Unit to display the Active Flight Plan Page on the MFD.
- 3) Turn the small **FMS** Knob to select the Flight Plan Catalog Page.
- 4) Press the **FMS** Knob to activate the cursor.

- 5) Turn either **FMS** Knob to highlight an empty or existing flight plan.
- 6) Press the **IMPORT** Softkey; or press the **MENU** Key, select “Import Flight Plan”, and press the **ENT** Key.

If an empty slot is selected, a list of the available flight plans on the SD card will be displayed.

Or:

If an existing flight plan is selected, an “Overwrite existing flight plan? OK or CANCEL” prompt is displayed. Press the **ENT** Key to choose to overwrite the selected flight plan and see the list of available flight plans on the SD card. If overwriting the existing flight plan is not desired, select “CANCEL” using the **FMS** Knob, press the **ENT** Key, select another flight plan slot, and press the **IMPORT** Softkey again.



Figure 8-13 List of Flight Plans to Import

- 7) Turn the small **FMS** Knob to highlight the desired flight plan for importing.
- 8) Press the **ENT** Key to initiate the import.



Figure 8-14 Import Successful

- 9) Press the **ENT** Key again to confirm the import.

8.9 ENTER AN AIRWAY IN A FLIGHT PLAN

- 1) Press the **FPL** Key to display the active flight plan or display a stored flight plan.
- 2) Press the **FMS** Knob to activate the cursor.
- 3) Turn the large **FMS** Knob to highlight the waypoint before which the airway is to be entered.

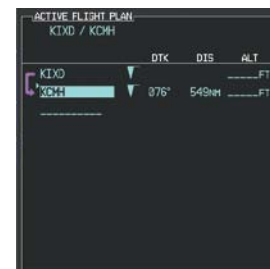

Figure 8-15 Airway Insertion Point

- 4) Turn the small **FMS** Knob to display the Waypoint Information Window and begin entering the desired airways entry point.



Figure 8-16 Load Airway Entry Point

- 5) When the desired entry point is entered, press the **ENT** Key.



Figure 8-17 Airway Entry Point Loaded

- 6) Turn the small **FMS** Knob to display the Waypoint Information Window and begin entering the desired airway identifier.

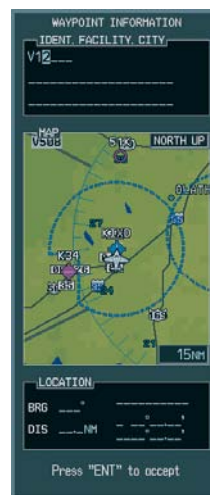

Figure 8-18 Enter Airway Identifier

- 7) When the desired airway is entered, press the **LD AIRWY** Softkey.
- 8) Turn either **FMS** Knob to scroll through the list of available exit points.

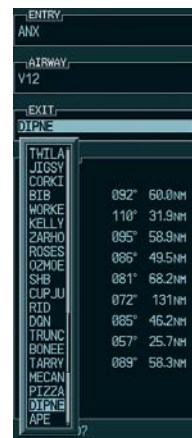

Figure 8-19 Select Desired Exit Point

- 9) With the desired exit point highlighted, press the **ENT** Key.
- 10) With 'LOAD?' highlighted, press the **ENT** Key.

ACTIVE FLIGHT PLAN			
KIND / KCH	DTK	DTS	ALT
SHB	076°	7.0nm	FT
CUPJU	085°	15.0nm	FT
RID	085°	31.2nm	FT
DGN	057°	25.7nm	FT
TRUNC	089°	18.2nm	FT
BONEE	090°	18.6nm	FT
TARRY	082°	1.6nm	FT
MECAN	090°	18.8nm	FT
PIZZA	091°	8.3nm	FT
DIPNE	091°	8.9nm	FT
KCH	128°	13.2nm	FT

Figure 8-20 Airway Added to Flight Plan

8.10 LOAD A DEPARTURE

See the Procedures section for a discussion on loading and activating departure procedures.

8.11 LOAD AN ARRIVAL

See the Procedures section for a discussion on loading and activating arrival procedures.

8.12 LOAD AN APPROACH

See the Procedures section for a discussion on loading and activating approach procedures.

8.13 REMOVE A DEPARTURE, ARRIVAL, APPROACH, OR AIRWAY FROM A FLIGHT PLAN

- 1) With the Active or Stored Flight Plan Page displayed, press the **FMS** Knob to activate the cursor.
- 2) Turn the large **FMS** Knob to highlight the title for the approach, departure, arrival, or airway to be deleted. Titles appear in white directly above the procedure's waypoints.
- 3) Press the **CLR** Key to display a confirmation window. With 'OK' highlighted, press the **ENT** Key to remove the selected procedure or airway.

8.14 STORE A FLIGHT PLAN

- 1) After creating a flight plan on either the PFD or MFD, it may be saved by pressing the **MENU** Key.
- 2) Turn the large **FMS** Knob to highlight 'Store Flight Plan' and press the **ENT** Key.
- 3) With 'OK' highlighted, press the **ENT** Key to store the flight plan.

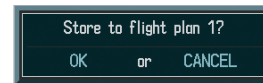

Figure 8-21 Store Flight Plan Confirmation

8.15 EDIT A STORED FLIGHT PLAN

- 1) Press the **FPL** Key and turn the small **FMS** Knob to display the Flight Plan Catalog Page.
- 2) Press the **FMS** Knob to activate the cursor.
- 3) Turn the large **FMS** Knob to highlight the desired flight plan and press the **ENT** Key.
- 4) Turn the large **FMS** Knob to place the cursor in the desired locations for entering changes.
- 5) Turn the **FMS** Knobs to make the desired changes, then press the **ENT** Key.
- 6) Press the **FMS** Knob to return to the Flight Plan Catalog Page.

8.16 DELETE A WAYPOINT FROM THE FLIGHT PLAN

- 1) With either the Active or Stored Flight Plan displayed, press the **FMS** Knob to activate the cursor.
- 2) Turn the large **FMS** Knob to select the waypoint to be deleted.

- 3) Press the **CLR** Key to display a 'REMOVE (Wpt Name)' confirmation window.

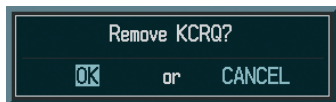

Figure 8-22 Remove Waypoint Confirmation

- 4) With 'OK' highlighted, press the **ENT** Key to remove the waypoint. To cancel the delete request, turn the large **FMS** Knob to highlight 'CANCEL' and press the **ENT** Key.
- 5) Once all changes have been made, press the **FMS** Knob to remove the cursor.

8.17 INVERT AND ACTIVATE A STORED FLIGHT PLAN

- 1) From the Flight Plan Catalog Page, press the **FMS** Knob to activate the cursor.
- 2) Turn the large **FMS** Knob to highlight the desired flight plan.
- 3) Press the **INVERT** Softkey. 'Invert and activate stored flight plan?' is displayed.
- 4) With 'OK' highlighted, press the **ENT** Key. The selected flight plan is now inverted and activated. The original flight plan remains intact in its flight plan catalog storage location.

8.18 COPY A FLIGHT PLAN

- 1) From the Flight Plan Catalog press the **FMS** Knob to activate the cursor
- 2) Turn the large **FMS** Knob to highlight the flight plan to be copied.
- 3) Press the **COPY** Softkey.

- 4) A 'Copy to flight plan #?' confirmation window is displayed. With 'OK' highlighted, press the **ENT** Key to copy the flight plan. To cancel, turn the large **FMS** Knob to highlight 'CANCEL' and press the **ENT** Key.

8.19 DELETE A FLIGHT PLAN

- 1) From the Flight Plan Catalog Page, press the **FMS** Knob to activate the cursor.
- 2) Turn the large **FMS** Knob to highlight the flight plan to be deleted.
- 3) Press the **DELETE** Softkey.
- 4) A 'Delete flight plan #?' confirmation window is displayed. With 'OK' highlighted, press the **ENT** Key to delete the flight plan. To cancel, turn the large **FMS** Knob to highlight 'CANCEL' and press the **ENT** Key.



NOTE: The option to delete all stored flight plans is not available while the aircraft is in flight.

8.20 GRAPHICAL FLIGHT PLAN CREATION

- 1) Press the **FPL** Key on the MFD to display the Active Flight Plan Page.
- 2) Press the **Joystick** to activate the map pointer. Use the **Joystick** to move the pointer to the desired point on the map to be inserted as a waypoint in the flight plan.
- 3) Press the **LD WPT** Softkey. The selected waypoint is inserted at the end of the flight plan. The default user waypoint naming is USR000, USR001, USR002 and so on.
- 4) If the selected waypoint is to be placed elsewhere in the flight plan, press the **FMS** Knob to activate the cursor. Waypoints are inserted *ABOVE* the cursor.

- 5) After placing the cursor at the desired point in the list of waypoints, press the **LD WPT** Softkey.
- 6) To change the user waypoint name, follow the procedure for modifying a user waypoint.

8.21 TRIP PLANNING

- 1) Turn the large **FMS** Knob to select the 'AUX' page group.
- 2) Turn the small **FMS** Knob to select TRIP PLANNING.
- 3) The current page mode is displayed at the top of the page: 'AUTOMATIC' or 'MANUAL'. To change the page mode, press the **AUTO** or **MANUAL** Softkey.

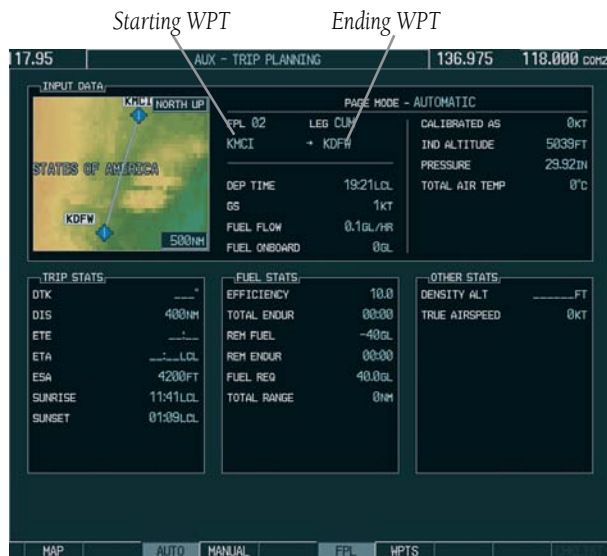

Figure 8-23 Trip Planning Page

- 4) For Direct-to planning, press the **WPTS** Softkey and verify that the starting waypoint field indicates 'P.POS' (present position). If necessary, press the **MENU** Key and select 'Set WPT to Present Position' to display 'P.POS'. Press the **ENT** Key and the flashing cursor moves to the ending waypoint field.

Turn the **FMS** Knobs to enter the identifier of the ending waypoint and press the **ENT** Key to accept the waypoint.

Or:

For point-to-point planning, turn the **FMS** Knobs to enter the identifier of the starting waypoint. Once the waypoints identifier is entered, press the **ENT** Key to accept the waypoint. The flashing cursor moves to the ending waypoint. Again, turn the **FMS** Knobs to enter the identifier of the ending waypoint and press the **ENT** Key to accept the waypoint.

Or:

For flight plan leg planning, press the **FPL** Softkey (at the bottom of the display) and turn the small **FMS** Knob to select the desired flight plan (already stored in memory), by number. Turn the large **FMS** Knob to highlight the 'LEG' field and turn the small **FMS** Knob to select the desired leg of the flight plan, or select 'CUM' to apply trip planning calculations to the entire flight plan. Selecting 'FPL 00' displays the active flight plan. If the active flight plan is selected, 'REM' is an available option to display planning data for the remainder of the flight plan.



NOTE: The Page Mode must be set to **MANUAL** to perform the following steps.

- 5) Turn the large **FMS** Knob to highlight the departure time (DEP TIME) field.



NOTE: The departure time on the Trip Planning Page is used for preflight planning. Refer to the Utility Page for the actual flight departure time.

- 6) Turn the **FMS** Knobs to enter the departure time. Press the **ENT** Key when finished. (Departure time may be entered in local or UTC time, depending upon system settings).

- 7) Turn the **FMS** Knobs to enter the fuel flow. Press the **ENT** Key when finished. Note that in automatic page mode, fuel flow is provided by the system.
- 8) The flashing cursor moves to the fuel on board field. Turn the **FMS** Knobs to modify the fuel on board. Press the **ENT** Key when finished. In 'AUTOMATIC' mode, fuel onboard is provided by the entry made in 'GAL REM' on the EIS System Page.
- 9) The flashing cursor moves to the calibrated airspeed field. Turn the **FMS** Knobs to enter a calibrated airspeed. Press the **ENT** Key when finished.
- 10) The flashing cursor moves to the indicated altitude field. Turn the **FMS** Knobs to enter indicated altitude. Press the **ENT** Key when finished.
- 11) The flashing cursor moves to the barometric pressure field. Turn the **FMS** Knobs to enter the altimeter barometric pressure setting. Press the **ENT** Key when finished.
- 12) The flashing cursor moves to the total air temperature field. Turn the **FMS** Knobs to enter the total air temperature. Press the **ENT** Key when finished.

8.22 EXPORT A FLIGHT PLAN TO AN SD CARD



NOTE: See the *Annunciations & Alerts* section for flight plan export message descriptions.

- 1) Insert the SD card into the top card slot on the MFD.
- 2) Press the **FPL** Key to display the Active Flight Plan Page on the MFD.
- 3) Turn the small **FMS** Knob to select the Flight Plan Catalog Page.
- 4) Press the **FMS** Knob to activate the cursor.

- 5) Turn the large **FMS** Knob to highlight the flight plan to be exported.
- 6) Press the **EXPORT** Softkey.



Figure 8-24 Stored Flight Plan to be Exported & Exported Flight Plan Name

- 7) Press the **ENT** Key to confirm the export.



Figure 8-25 Export Successful

SECTION 9: PROCEDURES

9.1 ARRIVALS AND DEPARTURES

Load and Activate a Departure Procedure

- 1) Press the **PROC** Key.
- 2) Turn the large **FMS** Knob to highlight 'SELECT DEPARTURE'.
- 3) Press the **ENT** Key.
- 4) If a flight plan is active, the departure airport is displayed as the default. A list of available departures is also displayed. If no flight plan is active, use the **FMS** Knobs to enter the identifier of the desired airport. Press the **ENT** Key.
- 5) Turn the large **FMS** Knob to highlight the Departure field. Turn the small **FMS** Knob to display a list of available departures.
- 6) Turn either **FMS** Knob to select the desired departure and press the **ENT** Key.



Figure 9-1 Select Departure

- 7) A list of runways may be displayed for the departure. Turn either **FMS** Knob to select the desired runway and press the **ENT** Key.
- 8) A list of available transitions is displayed for the departure. Turn either **FMS** Knob to highlight the desired transition waypoint and press the **ENT** Key.



Figure 9-2 Select Departure Transition

- 9) With 'LOAD?' highlighted, press the **ENT** Key. The departure is active when the flight plan is active.

Load and Activate An Arrival Procedure



NOTE: If any portion of an arrival procedure is the active leg of a flight plan, the existing arrival procedure must be deleted before changing to a different arrival procedure.

- 1) Press the **PROC** Key.
- 2) Turn the large **FMS** Knob to highlight 'SELECT ARRIVAL'.
- 3) Press the **ENT** Key.
- 4) If a flight plan is active, the destination airport is displayed as the default. A list of available arrivals is also displayed. If no flight plan is active, use the **FMS** Knobs to enter the identifier of the desired airport. Press the **ENT** Key.
- 5) Turn the large **FMS** Knob to highlight the Arrival field. Turn the small **FMS** Knob to display a list of available arrivals.
- 6) Turn either **FMS** Knob to select the desired arrival and press the **ENT** Key.



Figure 9-3 Select Arrival

- 7) A second window is displayed listing available transitions for the arrival. Turn either **FMS** Knob to highlight the desired transition waypoint and press the **ENT** Key.



Figure 9-4 Select Arrival Transition

- 8) A third window is displayed listing the available runways. Turn either **FMS** Knob to select the desired runway and press the **ENT** Key.



Figure 9-5 Select Arrival Runway

- 9) With 'LOAD?' highlighted, press the **ENT** Key. If a flight plan is active, the selected arrival procedure is inserted after the destination airport and becomes part of the active flight plan. If no flight plan is active when the arrival is loaded, the arrival procedure becomes the active flight plan.

9.2 APPROACHES



NOTE: If certain GPS parameters (SBAS, RAIM, etc.) are not available, some published approach procedures for the desired airport may not be displayed in the list of available approaches.

Not all approaches in the database are approved for GPS use. When selecting an approach, a “GPS” designation to the right of the procedure name indicates the procedure can be flown using the GPS receiver. Some procedures do not have this designation, meaning the GPS receiver can be used for supplemental navigation guidance only. If the GPS receiver cannot be used for primary guidance, the appropriate navigation receiver must be used for the selected approach (e.g., VOR or ILS). The final course segment of ILS approaches, for example, must be flown by tuning the Nav receiver to the proper frequency and selecting that Nav receiver on the CDI.

The G1000 GPS allows for flying LNAV, LNAV/VNAV (SBAS only), and LPV (SBAS only) approaches according to the published chart. The active approach type is annunciated on the HSI as shown in the following table:

HSI ANNUNCIATION	DESCRIPTION
LNAV	GPS approach using published LNAV minima.
LNAV+V*	GPS approach using published LNAV minima. Advisory vertical guidance is provided.
L/VNAV*	GPS approach using published LNAV/VNAV minima.
LPV*	GPS approach using published LPV minima.
* SBAS systems only	

Load and/or Activate an Approach Procedure

- 1) Press the **PROC** Key.
- 2) Turn the large **FMS** Knob to highlight 'SELECT APPROACH'.
- 3) Press the **ENT** Key.
- 4) If a flight plan is active, the destination airport is displayed as the default. A list of available approaches is also displayed. If no flight plan is active, use the **FMS** Knobs to enter the identifier of the desired airport. Press the **ENT** Key.
- 5) Turn the large **FMS** Knob to highlight the Approach field. Turn the small **FMS** Knob to display a list of available approaches.



Figure 9-6 Selecting an Approach Procedure

- 6) Turn either **FMS** Knob to highlight the desired approach. Press the **ENT** Key.
- 7) The cursor moves to the TRANSITIONS field. Turn the large **FMS** Knob to highlight the desired transition waypoint and press the **ENT** Key. (The "Vectors" option assumes vectors will be received to the final course segment of the approach and will provide navigation guidance relative to the final approach course.)



Figure 9-7 Selecting an Approach Transition

- 8) The cursor moves to the MINIMUMS field. If desired, the decision altitude for the selected approach procedure may be entered and displayed on the PFD as described in the Barometric Altitude Minimums discussion in the Flight Instruments section. Turn the small **FMS** Knob in the direction of the green arrow to change the display from OFF to BARO. Press the **ENT** Key.



Figure 9-8 Selecting Barometric Altitude Minimums

- 9) The cursor moves to the altitude field. Turn the small **FMS** Knob to enter the published decision altitude for the selected approach procedure. Press the **ENT** Key.



Figure 9-9 Entering Minimum Altitude

- 10) Turn the large **FMS** Knob to highlight 'Activate?' and press the **ENT** Key to activate the approach. Activating the approach initiates a direct-to for IAF and the G1000 immediately begins navigating to the IAF. Selecting 'Load?' adds the procedure to the flight plan without immediately using it for navigation guidance.

Activate An Approach in the Active Flight Plan

- 1) With the Navigation Map Page displayed, press the **PROC** Key.
- 2) Turn the large **FMS** Knob to highlight 'ACTIVATE APPROACH'.
- 3) Press the **ENT** Key. The approach procedure is now active and a direct-to is initiated to the IAF.

Activate A Missed Approach in the Active Flight Plan

- 1) Press the **PROC** Key.
- 2) Turn the large **FMS** Knob to highlight 'ACTIVATE MISSED APPROACH'.
- 3) Press the **ENT** Key. A confirmation window is displayed.
- 4) With 'ACTIVATE' highlighted, press the **ENT** Key.

Or:

Press the GA switch.

SECTION 10: HAZARD AVOIDANCE

10.1 CUSTOMIZING THE HAZARD DISPLAYS ON THE NAVIGATION MAP

- 1) With the Navigation Map Page displayed, press the **MENU** Key to display the Navigation Map Page Menu. The cursor flashes on the 'Map Setup' option.
- 2) Press the **ENT** Key. The Map Setup Menu is displayed. Turn the small **FMS** Knob to select the 'Weather' group (Figure 10-2) to customize the display of weather features. Select 'Traffic' to customize the display of traffic.
- 3) Press the small **FMS** Knob to return to the Navigation Map Page.

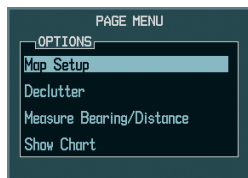

Figure 10-1 Page Menu



Figure 10-2 Map Setup Menu

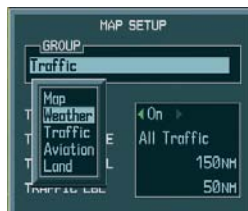

Figure 10-3 Map Setup Group List

10.2 STORMSCOPE® (OPTIONAL)



WARNING: The Stormscope system is not intended to be used for hazardous thunderstorm penetration. Weather information on the G1000 MFD is approved for weather avoidance only. Refer to the WX-500 Pilot's Guide for detailed operation.

Displaying Stormscope Lightning Data on the Navigation Map Page

- 1) Press the **MAP** Softkey.
- 2) Press the **STRMSCP** Softkey. Press the **STRMSCP** Softkey again to remove Stormscope Lightning Data from the Navigation Map Page.



Figure 10-4 In-Flight Navigation Map Page Displaying Stormscope Lightning Data

Lightning Age	Symbol
Strike is less than 6 seconds old	
Strike is between 6 and 60 seconds old	
Strike is between 1 and 2 minutes old	
Strike is between 2 and 3 minutes old	

Table 10-1

At a map range of less than 25 nm, Stormscope lightning data is not displayed, but can still be present.

Select 'cell' or 'strike' as the Stormscope lightning mode:

- 1) With the Weather Group selected, press the **ENT** Key. The cursor flashes on 'STRMSCP LTNG'.
- 2) Turn the large **FMS** Knob to select 'STRMSCP MODE'.
- 3) Turn the small **FMS** Knob to display the 'Cell/Strike' window.
- 4) Turn either **FMS** Knob to select 'Cell' or 'Strike'. Press the **ENT** Key.
- 5) Push the **FMS** Knob to return to the Navigation Map Page.

Clear Stormscope lightning data from the Navigation Map Page:

- 1) Press the **MENU** Key (with the Navigation Map Page displayed).
- 2) Turn either **FMS** Knob to highlight the 'Clear Stormscope® Lightning' field and press the **ENT** Key.



NOTE: If heading input is lost, strikes and/or cells must be cleared manually after the execution of each turn. This is to ensure that the strike and/or cell positions are depicted accurately in relation to the nose of the aircraft.

Stormscope Page

- 1) Turn the large **FMS** Knob to select the 'MAP' page group.
- 2) Turn the small **FMS** Knob to select STORMSCOPE.



Figure 10-5 Stormscope Page

Change the Stormscope lightning mode between 'cell' and 'strike':

- 1) Select the Stormscope Page.
- 2) Press the **MODE** Softkey. The **CELL** and **STRIKE** Softkeys are displayed. Press the **CELL** Softkey to display 'CELL' data or press the **STRIKE** Softkey to display 'STRIKE' data. 'CELL' or 'STRIKE' is displayed in the mode box located in the upper left corner of the Stormscope Page.



NOTE: "Cell mode" uses a clustering program to identify clusters of electrical activity that indicate cells.

Change the viewing mode between 360° and 120°:

- 1) Select the Stormscope Page.
- 2) Press the **VIEW** Softkey. The **360** and **ARC** Softkeys are displayed. Press the **360** Softkey to display a 360° viewing area or press the **ARC** Softkey to display a 120° viewing area.

Press the **CLEAR** Softkey to remove all Stormscope lightning data from the display.

10.3 XM WEATHER (SERVICE OPTIONAL)



WARNING: XM Weather is not intended to be used for hazardous weather penetration. Weather information provided by XM Radio Service is approved only for weather avoidance, not penetration.

- 1) From the Navigation Map Page, press the **MAP** Softkey.
- 2) Press the **NEXRAD** or **XM LTNG** Softkey to display the desired weather. Press the applicable softkey again to remove weather data from the Navigation Map Page.

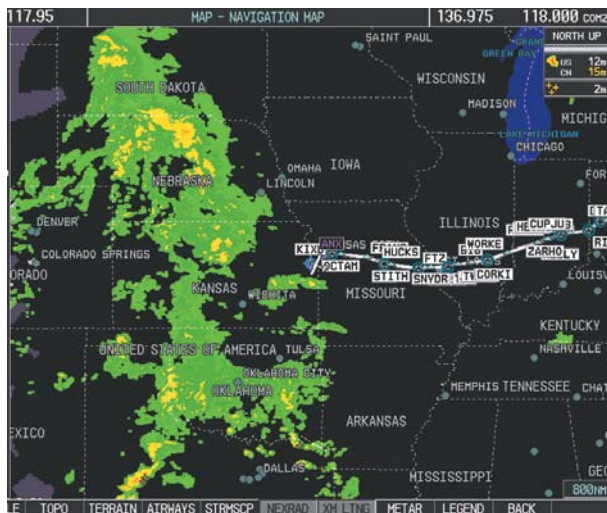

Figure 10-6 Navigation Map Page Displaying NEXRAD Weather



NOTE: Weather is not displayed on the Navigation Map Page at zoom levels less than 10 nm.

Displaying METAR and TAF information on the Airport Information Page

- 1) Turn the large **FMS** Knob to select the 'WPT' page group.

- 2) Turn the small **FMS** Knob to select AIRPORT INFORMATION.
- 3) Press the **WX** Softkey to display METAR and TAF text (METAR and TAF information is updated every 12 minutes).

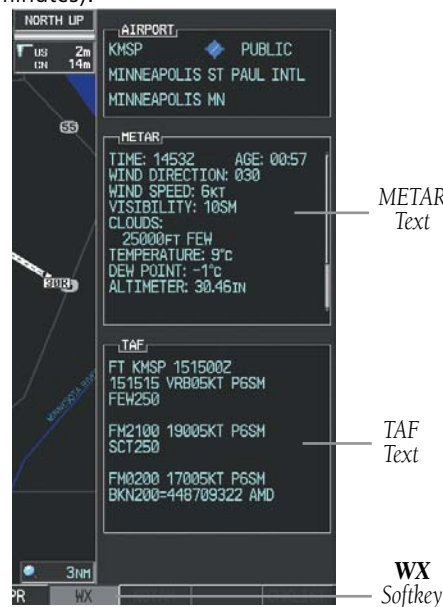

Figure 10-7 METAR and TAF Text Displayed on the Airport (Weather) Information Page

Raw METAR text is also accessible while panning the map cursor over a METAR flag on any map page on which a METAR is displayed. The METAR text is shown in a box near the METAR flag.

In addition, METAR flags and their associated text are displayed on the Active Flight Plan Page on the MFD. METAR flags appear next to waypoints in the flight plan with an associated METAR. A solid light blue METAR flag indicates the METAR observations are available for specific waypoint; a hollow light blue METAR flag indicates an off-route METAR is available near the waypoint.

Displaying Weather on the Weather Data Link Page

Select the Weather Data Link Page:

- 1) Turn the large **FMS** Knob to select the 'MAP' page group.
- 2) Turn the small **FMS** Knob to select WEATHER DATA LINK.
- 3) Press the available softkeys to select the desired XM weather product.
- 4) Press the **LEGEND** Softkey to view the legends for the selected products. If necessary, turn either **FMS** Knob to scroll through the list. Press the small **FMS** Knob or the **ENT** Key to return to the map.

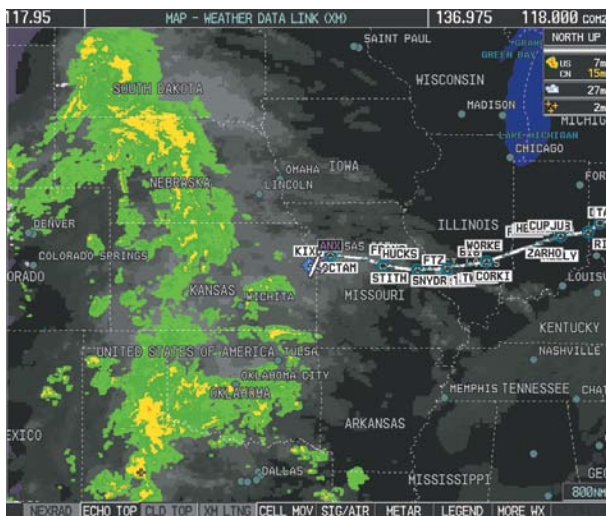

Figure 10-8 Weather Data Link Page (XM)

NEXRAD – Press the **NEXRAD** Softkey to show NEXRAD weather and radar coverage information. Areas where radar coverage is not available are shown in grayish-purple. The display is updated every five minutes.

NEXRAD Limitations

Certain limitations exist regarding the NEXRAD radar displays. Some, but not all, are listed here:

- NEXRAD base reflectivity does not provide sufficient information to determine cloud layers or precipitation characteristics (hail vs. rain, etc).
- An individual NEXRAD site cannot depict high altitude storms at close ranges, and has no information about storms directly over the site.
- The resolution of displayed NEXRAD data is 4 square kilometers. Therefore, when zoomed in on the display, each square block is 2 kilometers on each side. The intensity level reflected by the square is the highest level sampled within the square area.

ECHO TOP – Press the **ECHO TOP** Softkey to show the location, elevation, and direction the highest radar echo. This may not indicate the top of a storm or clouds, only the highest radar return echo. ECHO TOPS cannot be displayed along with NEXRAD and CLOUD TOPS. When ECHO TOPS is activated, NEXRAD and CLOUD TOPS are removed. Refer to the Legend for a description of the ECHO TOPS coding. The display is updated every 7.5 minutes.

CLD TOP – Press the **CLD TOP** Softkey to show the cloud top altitude determined from satellite imagery. The display is updated every 15 minutes.

LTNG – Pressing the **LTNG** Softkey shows the location of cloud-to-ground lightning strikes. The display is updated every five minutes.



NOTE: Strikes depicted represent cloud to ground strikes within a 2 kilometer radius of the actual strike location. Therefore, the exact location of the strike is not displayed.

CELL MOV – Pressing the **CELL MOV** Softkey shows storm cell movement by displaying an arrow pointing in the direction of predicted movement. The display is updated every 12 minutes.

SIG/AIR – Pressing the **SIG/AIR** Softkey shows SIGMET and AIRMET information. The display is updated every 12 minutes.

METAR – Press the **METAR** Softkey to graphically display METARs. METARs are shown as colored flags at airports providing METAR reports. The display is updated every 12 minutes.

MORE WX – Press the **MORE WX** Softkey to display the following group of softkeys for additional weather control:

SFC – Pressing the **SFC** Softkey for Surface Analysis shows current or forecast conditions. Forecasts are available for intervals of Current, 12, 24, 36, and 48 hours. Press the softkey corresponding to the desired forecast. The closest city forecast information is displayed in the legend. The display is updated every 12 minutes.

FRZ LVL – Press the **FRZ LVL** Softkey to display contour lines for freezing levels. The display is updated every 12 minutes.

WIND – Press the **WIND** Softkey to show wind speed and direction at a selected altitude from the ground up to 42,000 feet in 3,000 foot increments. After pressing the **WIND** Softkey, press the softkey corresponding to the desired winds aloft altitude. The display is updated every 12 minutes.

COUNTY – Pressing the **COUNTY** Softkey provides specific public awareness and protection weather warnings for Tornado, Severe Thunderstorm, and Flood conditions provided by the National Weather Service (NWS). The display is updated every 5 minutes.

CYCLONE – Pressing the **CYCLONE** Softkey shows the current location of cyclones (hurricanes and tropical storms) and their projected track at various time intervals. The update rate is every 12 minutes.

Map Panning Information – Weather Data Link Page

- 1) Push in the **Joystick** to display the panning arrow.
- 2) Move the **Joystick** to place the panning arrow on AIRMETs, TFRs, METARs, or SIGMETs. Press the **ENT** Key to display pertinent information for the selected product.

Note that pressing the **ENT** Key when panning over an AIRMET or a SIGMET displays an information box that displays the text of the report. Panning over an airport with METAR information does not display more information but allows the user to press the **ENT** Key and select that Airport's Information Page to display the text of the report. Pressing the **ENT** Key when panning over a TFR displays TFR specific information.

Displaying TFR Data:

- 1) Select the Weather Data Link (XM) Page or Navigation Map Page.
- 2) Press the **RANGE** Knob and pan the map pointer over a TFR to highlight it. The system displays TFR summary information above the map.
- 3) Press the **ENT** Key. The system displays a pop-up menu.
- 4) If necessary, turn the **FMS** Knob to select 'Review Airspaces' and press the **ENT** Key. The system displays the TFR Information window.
- 5) Press the **FMS** Knob or the **CLR** Key to remove the TFR Information window.

Enabling/disabling winds aloft data display in Profile View:

- 1) Select the Navigation Map Page.
- 2) Press the **MENU** Key.
- 3) With Map Setup highlighted, press the **ENT** Key
- 4) Turn the small **FMS** Knob to select the Profile Group and press the **ENT** Key
- 5) Turn the large **FMS** Knob to select 'Profile Winds'.
- 6) Turn the small **FMS** Knob to select 'On' or 'Off'.
- 7) Press the **FMS** Knob or **CLR** Key to return to the Navigation Map Page with the changed settings.



Weather Products & Symbols

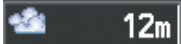
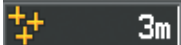
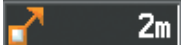

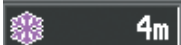



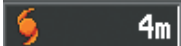
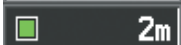

Table 10-2 depicts the symbol for each weather product. When a weather product is active, the product symbol is displayed in the lower right of the screen.

The XM Information Page in the AUX page group displays the weather products available for the current subscription. A green box by the weather product means that it is available.

From within the AUX - XM INFORMATION Page, the pilot may switch to the AUX - XM RADIO Page by pressing the **RADIO** Softkey. Alternatively, the pilot may switch to the AUX - XM INFORMATION Page from the AUX - XM RADIO Page by pressing the **INFO** Softkey.

XM WX Satellite Weather Products and Symbols

Wx Product Status Icons	Description
	NEXRAD - Available for the US and Canada. The age of the displayed data for each is shown at the right.
	ECHO TOP - The age of the displayed data is shown at the right. Not displayed when CLOUD TOP is displayed.

Wx Product Status Icons	Description
	CLOUD TOP - The age of the displayed data is shown at the right. Not displayed when ECHO TOP is displayed.
	XM LIGHTNING - The age of the displayed data is shown at the right.
	CELL MOVEMENT - The age of the displayed data is shown at the right.
	SIGMET & AIRMET - The age of the displayed data for each is shown at the right.
	METAR - Available for the US and Canada. The age of the displayed data for each is shown at the right.
	FREEZING LEVEL - The age of the displayed data is shown at the right.
	SURFACE ANALYSIS with CITY FORECAST - The upper symbol depicts Surface Analysis. The lower symbol depicts City Forecast. The age of the displayed data for each is shown at the right. The selected forecast period is shown at the bottom.
	WINDS ALOFT - Available for the US and Canada. The age of the displayed data for each is shown at the right. The altitude selection is shown at the bottom.
	COUNTY WARNING - The age of the displayed data is shown at the right.
	CYCLONE WARNING - The age of the displayed data is shown at the right.
	AIREP - The age of the displayed data is shown at the right.
	PIREP - The age of the displayed data is shown at the right. Urgent Pireps are displayed in yellow.
	TURBULENCE - The age of the displayed data is shown at the right. The altitude selection is shown at the bottom.

Wx Product Status Icons	Description
	ICING POTENTIAL - The age of the displayed data is shown at the right. The altitude selection is shown at the bottom.
No Status Icon	TFR - Depicted as an area outlined in yellow

Table 10-2



NOTE: The **LOCK** Softkey on the **AUX - XM INFORMATION** Page is used to save the **GDL 69(A)** activation data when the **XM** services are initially set up. It is not used during normal operation of the **GDL 69(A)**, but it should have no adverse effects if inadvertently selected during flight. Refer to the **GDL 69/69A XM Satellite Radio Activation Instructions (190-00355-04, Rev E or later)** for further information.

Weather Product Age

The age for each of the enabled products is displayed on the right side of the display. Times are based on GMT time when the data was assembled on the ground, not the time the data was received by the XM receiver. When the age of a weather product has exceeded half of the expiration time, the product time changes from light blue to amber in color.

Weather Product	Expires After (minutes)
SIGMETs/AIRMETs	60
City Forecasts	90
County Warnings	60
Cyclone Warnings	60
Echo Tops	30
Freezing Levels	60

Weather Product	Expires After (minutes)
METARs	90
Lightning	30
NEXRAD	30
Radar Coverage	30
Cell Movement	30
Surface Analysis	60
TFRs	60
Winds Aloft	60
TAFs	60
Clouds Tops	60
Icing	90
PIREPs	90
AIREPs	90
Turbulence	180

Table 10-3

10.4 FIS-B WEATHER (OPTIONAL)



NOTE: *FIS-B Weather provides information for avoiding hazardous weather. Do not utilize FIS-B Weather information to penetrate hazardous weather.*

Accessing FIS-B Weather Products

- 1) Turn the large **FMS** Knob to select the Map Page Group.
- 2) Turn the small **FMS** Knob to select the FIS-B Weather Data Link Page.

When a weather product is selected for display on the

FIS-B Weather Data Link Page, a box containing a symbol for the product and its age (in minutes) is shown in the upper right. If weather data has not been received yet, 'N/A' is shown next to the product symbol instead of age. The age of the weather product is based on the time difference between when the data was assembled on the ground and the current GPS time. Weather products are updated continuously or refreshed at specific intervals (defined in the **Refresh Rate** column in the following table).

If for any reason, a weather product is not refreshed within the defined **Expiration Time** intervals, the data is considered expired and is removed from the display. The age of the expired product is replaced by dashes. If more than half of the expiration time has elapsed, the color of the product age readout changes to yellow.

The refresh rate represents the interval at which the servers make available the most current known weather data. It does not necessarily represent the rate at which new content is received from weather sources.

Setting Up and Customizing the FIS-B Weather Data Link Page

- 1) Select the FIS-B Weather Data Link Page.
- 2) Press the **MENU** Key.
- 3) With 'Weather Setup' highlighted, press the **ENT** Key.
- 4) Turn the small **FMS** Knob to select 'Product Group 1' and press the **ENT** Key.
- 5) Turn the large **FMS** Knob or press the **ENT** Key to scroll through product selections.
- 6) Turn the small **FMS** Knob to scroll through options for each product (ON/OFF, range settings, etc.).
- 7) Press the **ENT** Key to select an option.
- 8) Press the **FMS** Knob or **CLR** Key to return to the FIS-B Weather Data Link Page with the changed settings.

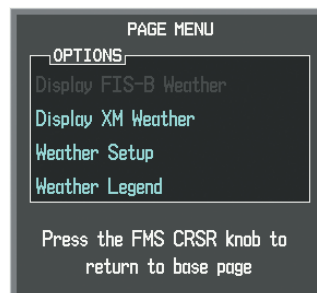

Figure 10-9 Weather Data Link Page (FIS-B) Menu



FIS-B Weather Product	Symbol	Expiration Time (Minutes)	Refresh Rate (Minutes)
Regional Radar Precipitation (PRECIP)		30	2.5
Meteorological Aerodrome Report (METARs)		90	5
Radar Coverage (RADAR CVRG)	no product image	30	2.5
Terminal Aerodrome Reports (TAFs)	no product image	60	10

Table 10-4

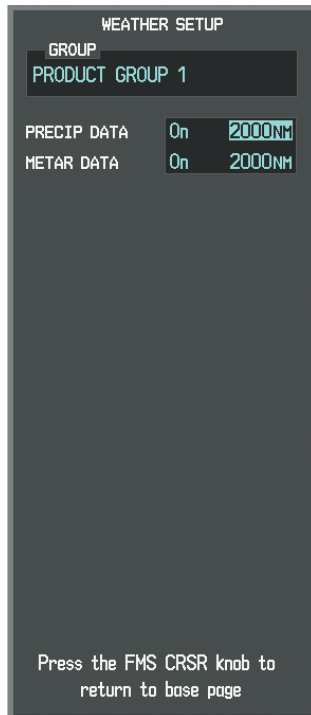

Figure 10-10 Weather Data Link Page Setup Menu

Restoring Default FIS-B Weather Data Link Page Settings

- 1) Select the FIS-B Weather Data Link Page.
- 2) Press the **MENU** Key.
- 3) With 'Weather Setup' highlighted, press the **ENT** Key.
- 4) Press the **MENU** Key.
- 5) Highlight the desired default(s) to restore (all or for selection) and press **ENT** Key.

Switching Between FIS-B, GFDS and XM WX Sources

- 1) Turn the large **FMS** Knob on the MFD to select the MAP page group.

- 2) Turn the small **FMS** Knob to select the desired Weather Data Link Page.
- 3) Press the **MENU** Key.
- 4) Turn the large **FMS** Knob to select 'Display GFDS Weather' or 'Display XM' Weather' or 'Display FIS-B Weather' (choice dependent on current weather source) and press the **ENT** Key.

Viewing Legends for Displayed FIS-B Weather Products

- 1) Select the FIS-B Weather Data Link Page.
- 2) Select the **LEGEND** Softkey to display the legends for the displayed weather products.
Or:
 - a) Press the **MENU** Key.
 - b) Select 'Weather Legend' and press the **ENT** Key.
- 3) Turn the **FMS** Knob to scroll through the legends if more are available than fit in the window.
- 4) To remove the Legend Window, select the **LEGEND** Softkey, the **ENT** or the **CLR** Key, or press the **FMS** Knob.

Setting Up and Customizing Weather Data for the Navigation Map Page

- 1) Select the Navigation Map Page.
- 2) Press the **MENU** Key.
- 3) With 'Map Setup' highlighted, press the **ENT** Key.
- 4) Turn the small **FMS** Knob to select the 'Weather' Group and press the **ENT** Key.
- 5) Turn the large **FMS** Knob or press the **ENT** Key to scroll through product selections.
- 6) Turn the small **FMS** Knob to scroll through options for each product (ON/OFF, range settings).
- 7) Press the **ENT** Key to select an option.

- 8) Press the **FMS** Knob or **CLR** Key to return to the Navigation Map Page with the changed settings.



Figure 10-11 Navigation Map Page Menu



Figure 10-12 Navigation Map Page Setup Menu

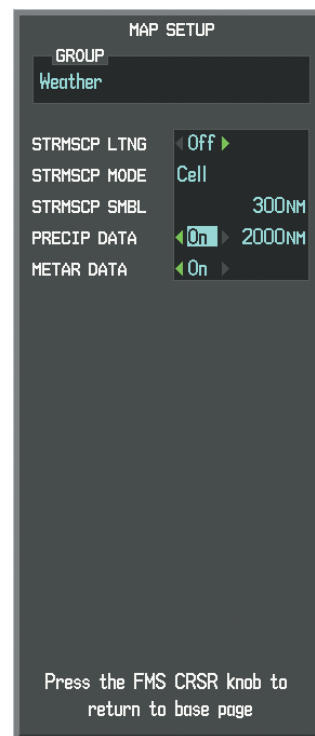

Figure 10-13 Navigation Map Page Setup Menu, Weather Group

FIS-B Weather Products

Precipitation

Precipitation data is not real-time. The lapsed time between collection, processing, and dissemination of radar images can be significant and may not reflect the current radar synopsis. Due to the inherent delays and the relative age of the data, it should be used for long-range planning purposes only.



NOTE: *Precipitation data cannot be displayed on the Navigation Map Page at the same time as terrain.*



Figure 10-14 Weather Data Link Page(FIS-B) PRECIP

DISPLAYING PRECIPITATION WEATHER INFORMATION

- 1) Select the **MAP** Softkey (for the PFD Inset Map, select the **INSET** Softkey). This step is not necessary on the FIS-B Weather Data Link Page.
- 2) Select the **PRECIP** Softkey.

METARs and TAFs



NOTE: METAR information is only displayed within the installed navigation database service area.

METAR and TAF text are displayed on the WPT-Weather Information Page. TAF information is displayed in its raw form when it is available.

DISPLAYING METAR AND TAF TEXT

- 1) On the FIS-B Weather Data Link Page, select the **METAR** Softkey.
- 2) Press the **RANGE** Knob and pan to the desired airport.

- 3) Press the **ENT** Key. The Weather Information Page is shown with METAR and TAF text.
- 4) Use the **FMS** Knob or the **ENT** Key to scroll through the METAR and TAF text. METAR text must be completely scrolled through before scrolling through the TAF text.
- 5) Press the **FMS** Knob or the **CLR** Key to return to the FIS-B Weather Data Link Page.

Or:

- 1) Select the Weather Information Page.
 - a) Turn the large **FMS** Knob to select the Waypoint Page Group.
 - b) Select the **WX** Softkey to select the Weather Information Page.
- 2) Press the **FMS** Knob to display the cursor.
- 3) Use the **FMS** Knob to enter the desired airport and press the **ENT** Key.
- 4) Use the **FMS** Knob or the **ENT** Key to scroll through the METAR and TAF text. Note that the METAR text must be completely scrolled through before scrolling through the TAF text.

To display the METAR legend on the FIS-B Weather Data Link Page, select the **LEGEND** Softkey when METARs are selected for display.

Instructions for Viewing METAR and TAF Text

Airport Selected with Map Pointer

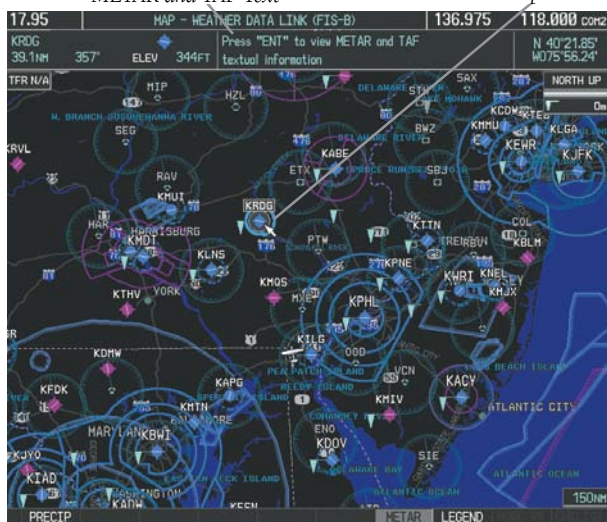

Figure 10-15 Weather Datalink (FIS-B) METAR



Figure 10-16 METAR Legend

10.5 WORLDWIDE WEATHER (OPTIONAL)



NOTE: Garmin Flight Data Services Worldwide Weather provides information for avoiding hazardous weather. Do not utilize Worldwide Weather information to penetrate hazardous weather.

Weather data is provided when the pilot initiates either a manual or automatic GFDS data request on the GFDS Weather Data Link Page on the MFD. No weather data is displayed until the first GFDS Weather Data Request is made.

Registering with Garmin Flight Data Services

A subscriber account must be established prior to receiving Worldwide Weather products. Contact Garmin Flight Data Services at 1-866-739-5687 in the United States or 913-397-8200, ext. 1135.

After a subscriber account has been established, the system must be registered for datalink features such as reporting services or GFDS Worldwide Weather. Registration is accomplished by entering the required access code. This process is only performed when initially setting up the system for GFDS services.

Registering the system for datalink services

- 1) With the aircraft outside and having a clear view of the sky, turn the large **FMS** Knob on the MFD to select the AUX page group.
- 2) Turn the small **FMS** Knob to select the AUX-SYSTEM STATUS. Note the System ID number in the AIRFRAME field.
- 3) Turn the large **FMS** Knob to select the MAP Page group.
- 4) Turn the small **FMS** Knob to select the MAP-WEATHER DATA LINK Page.

- 5) Press the **MENU** Key. If necessary, select 'Display GFDS Weather'.
- 6) Press **ENT** Key. The 'GARMIN FLIGHT DATA SERVICE REGISTRATION' Window is now displayed.
- 7) Press the **MENU** Key. The Page Menu window is now displayed.
- 8) Using the **FMS** Knob enter the access code obtained from Garmin Flight Data Services in the ACCESS CODE field.
- 9) Press the **ENT** Key. REGISTER will now be highlighted.
- 10) Press the **ENT** Key. System registration is complete when 'REGISTERED' is displayed in the STATUS field.

Switching Between GFDS, FIS-B and XM WX Sources

- 1) Turn the large **FMS** Knob on the MFD to select the MAP page group.
- 2) Turn the small **FMS** Knob to select the desired Weather Data Link Page.
- 3) Press the **MENU** Key.
- 4) Turn the large **FMS** Knob to select 'Display GFDS Weather' or 'Display XM' Weather' or 'Display FIS-B Weather' (choice dependent on current weather source) and press the **ENT** Key.

Accessing GFDS Worldwide Weather Products







- 1) Turn the large **FMS** Knob to select the Map Page Group.
- 2) Turn the small **FMS** Knob to select the GFDS Weather Data Link Page.

When a weather product is selected for display on the GFDS Weather Data Link Page, a box containing a symbol for the product and its age (in minutes) are shown in the upper right. If weather data has not been requested, 'N/A' is shown next to the product symbol instead of age. The

age of the weather product is based on the time difference between when the data was assembled on the ground and the current GPS time. Weather products are updated continuously or refreshed at specific intervals (defined in the **Refresh Rate** column in the following table).

If for any reason, a weather product is not refreshed within the defined **Expiration Time** intervals, the data is considered expired and is removed from the display. The age of the expired product is replaced by dashes. If more than half of the expiration time has elapsed, the color of the product age readout changes to yellow.

The refresh rate represents the interval at which the GFDS servers make available the most current known weather data. It does not necessarily represent the rate at which new content is received from weather sources.

Weather Product	Symbol	Expiration Time (Minutes)	Refresh Rate (Minutes)
Radar Precipitation (PRECIP)		30	U.S./Canada: 3* Europe: 15
Infrared Satellite (IR SAT)		60	30
Datalink Lightning (DL LTNG)		30	Continuous
SIGMETs/ AIRMETs (SIG/AIR)		60	Continuous
Meteorological Aerodrome Report (METARs)		90	Continuous
Winds Aloft (WIND)		60	Continuous

Weather Product	Symbol	Expiration Time (Minutes)	Refresh Rate (Minutes)
Pilot Weather Report (PIREPs)		90	Continuous
Temporary Flight Restrictions (TFRs)	no product image	60	Continuous
Terminal Aerodrome Reports (TAFs)	no product image	60	Continuous

* The composite precipitation image is updated every 3 minutes, but individual radar sites may take between 3 and 10 minutes to provide new data.

Table 10-5

Setting Up and Customizing the GFDS Weather Data Link Page

- 1) Select the GFDS Weather Data Link Page.
- 2) Press the **MENU** Key.
- 3) With 'Weather Setup' highlighted, press the **ENT** Key.
- 4) Turn the small **FMS** Knob to select 'Product Group 1' or 'Product Group 2', and press the **ENT** Key.
- 5) Turn the large **FMS** Knob or press the **ENT** Key to scroll through product selections.
- 6) Turn the small **FMS** Knob to scroll through options for each product (ON/OFF, range settings, etc.).
- 7) Press the **ENT** Key to select an option.
- 8) Press the **FMS** Knob or **CLR** Key to return to the GFDS Weather Data Link Page with the changed settings.



Figure 10-17 Weather Data Link (GFDS) Page Menu

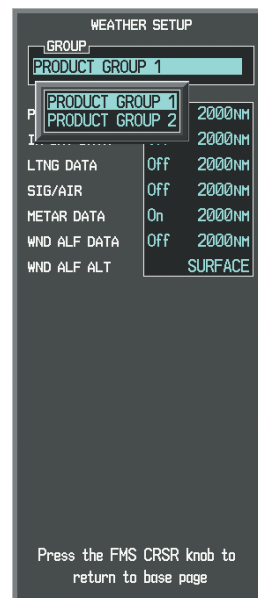

Figure 10-18 Weather Data Link (GFDS) Page Setup Menu

Restoring Default GFDS Weather Data Link Page Settings

- 1) Select the GFDS Weather Data Link Page.
- 2) Press the **MENU** Key.
- 3) With 'Weather Setup' highlighted, press the **ENT** Key.

- 4) Press the **MENU** Key.
- 5) Highlight the desired default(s) to restore (all or for selection) and press **ENT** Key.

Viewing Legends for Displayed GFDS Weather Products

- 1) Select the GFDS Weather Data Link Page.
- 2) Select the **LEGEND** Softkey to display the legends for the displayed weather products.

Or:

- a) Press the **MENU** Key.
- b) Select 'Weather Legend' and press the **ENT** Key.
- 3) Turn the **FMS** Knob to scroll through the legends if more are available than fit in the window.
- 4) To remove the Legend Window, select the **LEGEND** Softkey, the **ENT** or the **CLR** Key, or press the **FMS** Knob.

Setting Up and Customizing Weather Data for the Navigation Map Page

- 1) Select the Navigation Map Page.
- 2) Press the **MENU** Key.
- 3) With 'Map Setup' highlighted, press the **ENT** Key.
- 4) Turn the small **FMS** Knob to select the 'Weather' Group and press the **ENT** Key.
- 5) Turn the large **FMS** Knob or press the **ENT** Key to scroll through product selections.
- 6) Turn the small **FMS** Knob to scroll through options for each product (ON/OFF, range settings).
- 7) Press the **ENT** Key to select an option.
- 8) Press the **FMS** Knob or **CLR** Key to return to the Navigation Map Page with the changed settings.

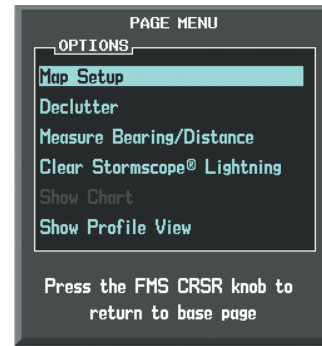

Figure 10-19 Navigation Map Page Menu



Figure 10-20 Navigation Map Page Setup Menu

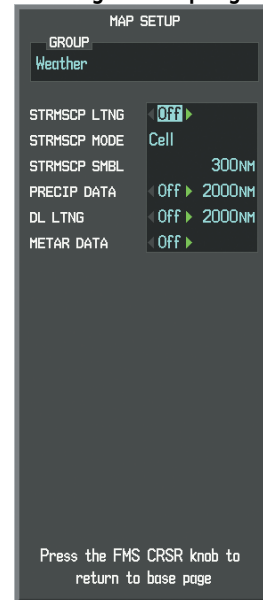

Figure 10-21 Navigation Map Page Setup Menu, Weather Group

GFDS Weather Data Requests

The GFDS Data Request window provides the flight crew with the options to define the requested weather coverage area(s), choose automatic weather update intervals (if desired), and the ability to send or cancel weather data requests. The window also displays the status of the GFDS data request process.

Requesting GFDS Weather Data Manually

- 1) Select the GFDS Weather Data Link Page.
- 2) Press the **MENU** Key.
- 3) With 'GFDS Weather Request' highlighted, press the **ENT** Key.
- 4) Turn the large **FMS** Knob to highlight the desired coverage option(s) and press the **ENT** Key to check or uncheck one or more of the following coverage selections:
 - **PRESENT POSITION** – Requests data based on current location.
 - **DESTINATION** – Requests data based on active flight plan destination (if the flight plan contains no destination, dashes '-----' are displayed.)
 - **FPL** – Requests data based on active flight plan. Turn the small **FMS** Knob to select the desired flight plan look-ahead distance option (or choose 'REMAINING FPL' to request the remainder of the flight plan).
 - **WAYPOINT** – Requests data based on any valid waypoint.
- 5) Turn the large **FMS** Knob highlight to the 'DIAMETER / RTE WIDTH' distance field and turn the small **FMS** Knob to select the desired diameter and route width of the request, then press the **ENT** Key.

- 6) Turn the large **FMS** Knob until the 'SEND REQ' button is highlighted. Press the **ENT** Key to initiate the request immediately or press the **FMS** Knob to return to the GFDS Data Link Page without requesting data.



Figure 10-22 Weather Data Link (GFDS) Page Menu

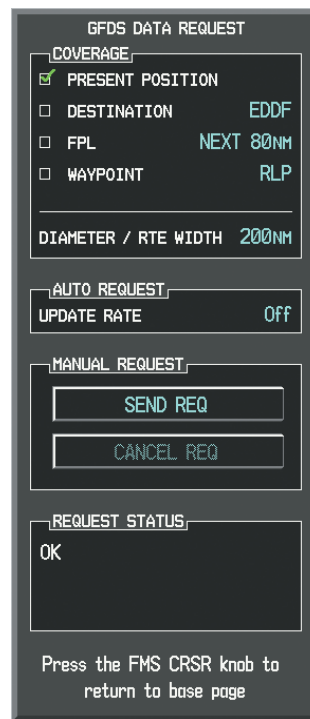
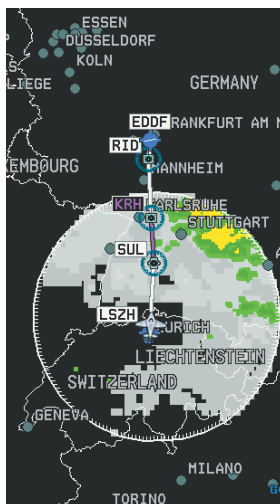

Figure 10-23 GFDS Data Request Window



GFDS DATA REQUEST	
COVERAGE	
<input checked="" type="checkbox"/>	PRESENT POSITION
<input type="checkbox"/>	DESTINATION EDDF
<input type="checkbox"/>	FPL NEXT 80NM
<input type="checkbox"/>	WAYPOINT RLP
DIAMETER / RTE WIDTH 200NM	

*Present Position Selected,
200 nm Diameter Requested*

Figure 10-24 Present Position Data Request

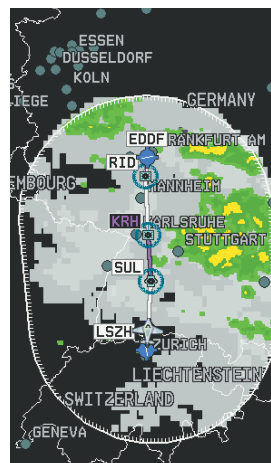

GFDS DATA REQUEST	
COVERAGE	
<input type="checkbox"/>	PRESENT POSITION
<input type="checkbox"/>	DESTINATION EDDF
<input checked="" type="checkbox"/>	FPL NEXT 80NM
<input type="checkbox"/>	WAYPOINT RLP
DIAMETER / RTE WIDTH 200NM	

*Next 80 nm of Flight Plan
Selected, 200 nm Route Width
Requested*

Figure 10-26 Route Data Request

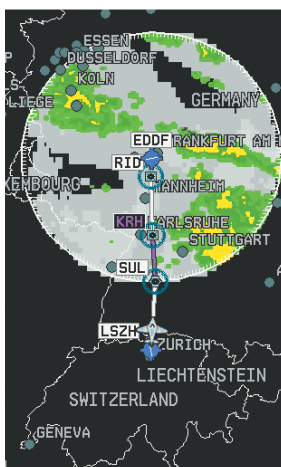

GFDS DATA REQUEST	
COVERAGE	
<input type="checkbox"/>	PRESENT POSITION
<input checked="" type="checkbox"/>	DESTINATION EDDF
<input type="checkbox"/>	FPL NEXT 80NM
<input type="checkbox"/>	WAYPOINT RLP
DIAMETER / RTE WIDTH 200NM	

*Destination Selected,
200 nm Diameter Requested*

Figure 10-25 Destination Data Request

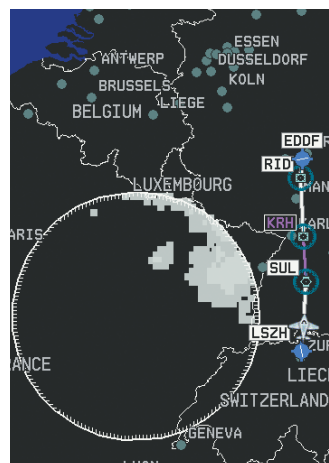

GFDS DATA REQUEST	
COVERAGE	
<input type="checkbox"/>	PRESENT POSITION
<input type="checkbox"/>	DESTINATION EDDF
<input checked="" type="checkbox"/>	WAYPOINT RLP
DIAMETER / RTE WIDTH 200NM	

*Off-Route Waypoint Selected,
200 nm Diameter Requested*

Figure 10-27 Off-Route Data Request

During a GFDS Data Request, the Request Status box initially displays “Contacting GFDS...”. Once a connection is established, the Request Status Box displays “Receiving Wx Data... Time Remaining:” with an estimated data transfer time (either minutes or seconds). If desired, the GFDS Data Request window may be closed while the

data request is processing by pressing the **FMS** Knob; the data request will continue to process in the background. GFDS Data Requests typically take between 1 to 4 minutes to complete depending on the size of the selected weather coverage area and Iridium signal strength.

The system retrieves all available Worldwide Weather products within the selected coverage area during an initial GFDS Data Request, regardless of which products (if any) are currently enabled for display. On subsequent requests, previously retrieved textual data (such as MET-ARs and TAFS) is retained if it has not expired, while new textual weather data matching the current coverage area and all graphical weather data is downloaded during every data request.

If the system cannot complete a GFDS weather data request, one or more messages will appear in the request status window as shown in the following table.

Weather Request Status Message	Description
Auto requests inhibited Send manual request to reset.	The system has disabled automatic weather data requests due to excessive errors. Automatic weather data requests have stopped. Send a manual weather data request to resume automatic updates.
Auto update retry: ## Seconds	The system will attempt another automatic weather data request after an error occurred during the previous request. Timer counts down until the next automatic request occurs.
GFDS Comm Error [2]	A communications error has occurred with the GIA. The system should be serviced.

Weather Request Status Message	Description
GFDS Comm Error [4]	This occurs if multiple automatic weather data requests have recently failed, or the GDL 59 or a GIA is off-line.
GFDS Comm Error [5]	The Iridium or GFDS networks are not accessible. Check Iridium signal strength. If this error persists, the G1000 should be serviced.
GFDS Comm Error [6]	A communications error has occurred. If this error persists, the system should be serviced.
GFDS Comm Error [7]	A weather data transfer has timed out. Check Iridium signal strength and re-send the data request.
GFDS Comm Error [8]	A server error has occurred or invalid data received.
GFDS Login Invalid	There is a problem with the GFDS registration. Contact Garmin Flight Data Services at 1-866-739-5687 in the United States or 913-397-8200, ext. 1135 for assistance.
GFDS Server Temporarily Inop	The GFDS weather data server is temporarily out of service, but is expected to return to service in less than 30 minutes.
GFDS Server Inop	The GFDS weather data server will be out of service for at least 30 minutes.
Reduce Request Area	The GFDS weather data request area exceeds size limits. Reduce weather coverage area and re-send data request.

Weather Request Status Message	Description
Request Failed - Try Again	The weather data request timed-out. Re-send data request.
Invalid Coverage Area	The weather data request coverage area does not contain at least one of the following: a waypoint, a flight plan, or a flight plan destination. Verify at least one of the coverage options is enabled (checked) and contains required criteria, then re-send the data request.
No GFDS Subscription	The system is not be currently subscribed to GFDS, or the access code is incorrect. Verify the access code. Contact Garmin Flight Data Services at 1-866-739-5687 in the United States or 913-397-8200, ext. 1135 for assistance.
Request Cancelled	The user has cancelled a GFDS weather data request.
Requested area too large. Reduce coverage area.	The size of the GFDS weather data request has exceeded limits. Reduce the size of the coverage area and try the weather data request again.
Transfer Preempted	The datalink is busy. Retry request later.

Table 10-6

Canceling a GFDS Weather Data Request in Progress

- 1) Select the GFDS Weather Data Link Page.
- 2) Press the **MENU** Key.
- 3) With 'GFDS Data Request' highlighted, press the **ENT** Key.

- 4) Turn the large **FMS** Knob to select 'CANCEL REQ' and press the **ENT** Key. The request status box indicates 'Request Cancelled'.
- 5) Press the **FMS** Knob to return to the GFDS Weather Datalink Page.

Enabling Automatic GFDS Data Requests

- 1) Select the GFDS Weather Data Link Page.
- 2) Press the **MENU** Key.
- 3) With 'GFDS Weather Request' highlighted, press the **ENT** Key.
- 4) Choose the desired weather coverage options.
- 5) Turn the large **FMS** Knob to select the 'UPDATE RATE' setting. Then turn the small **FMS** Knob to highlight the desired automatic update frequency (OFF, 5 Min, 10 Min, 15 Min, 20 Min, 25 Min, 30 Min, 45 Min, or 60 Min), then press the **ENT** Key.
- 6) The 'SEND REQ' button is highlighted and a countdown timer is displayed in the 'REQUEST STATUS' based on the currently selected update rate. Press the **ENT** Key to immediately send an immediate GFDS Data Request.

Or:

Press the **FMS** Knob to return to the GFDS Weather Data Link Page.

Worldwide Weather Products

Precipitation

Precipitation data is not real-time. The lapsed time between collection, processing, and dissemination of radar images can be significant and may not reflect the current radar synopsis. Due to the inherent delays and the relative age of the data, it should be used for long-range planning purposes only.



NOTE: Precipitation data cannot be displayed on the Navigation Map Page at the same time as terrain.

DISPLAYING PRECIPITATION WEATHER INFORMATION

- 1) Select the **MAP** Softkey (for the PFD Inset Map, select the **INSET** Softkey). This step is not necessary on the GFDS Weather Data Link Page.
- 2) Select the **PRECIP** Softkey.

Radar data shown represents lowest level, base reflectivity, of radar returns. The display of the information is color-coded to indicate the weather severity level. All weather product legends can be viewed on the GFDS Weather Data Link Page. For the Precipitation legend, select the **LEGEND** Softkey when Precipitation is selected for display.

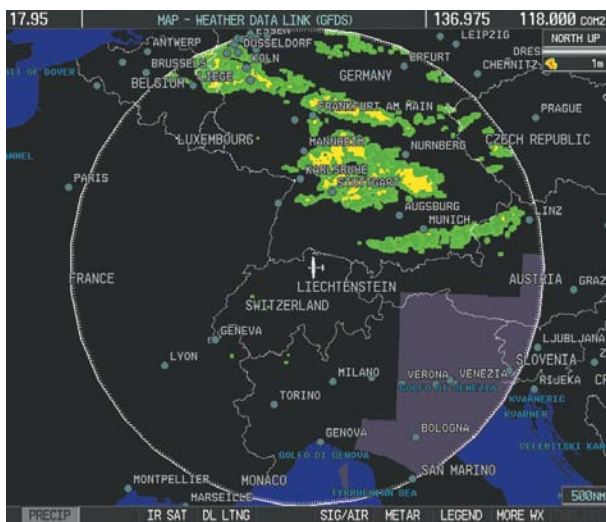

Figure 10-28 Weather Data Link Page (GFDS) PRECIP

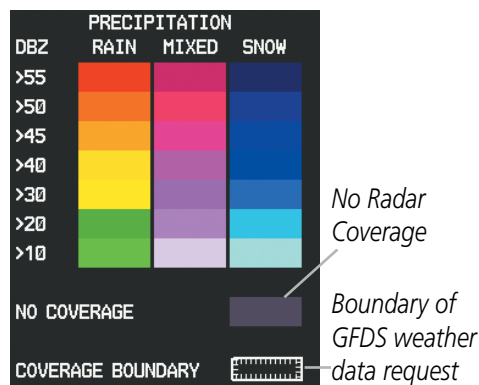

Figure 10-29 Precipitation Data Legend

PRECIPITATION LIMITATIONS

Radar images may have certain limitations:

- Radar base reflectivity does not provide sufficient information to determine cloud layers or precipitation characteristics (wet hail vs. rain). For example, it is not possible to distinguish between wet snow, wet hail, and rain.
- Radar base reflectivity is sampled at the minimum antenna elevation angle. An individual radar site cannot depict high altitude storms at close ranges. It has no information about storms directly over the site.
- When zoomed in to a range of 30 nm, each square block on the display represents an area of four square kilometers.

The following may cause abnormalities in displayed radar images:

- Ground clutter
- Strokes and spurious radar data
- Sun strokes (when the radar antenna points directly at the sun)
- Interference from buildings or mountains, which may cause shadows
- Metallic dust from military aircraft, which can cause alterations in radar scans

Infrared Satellite

Infrared Satellite (IR SAT) data depicts cloud top temperatures from satellite imagery. Brighter cloud top colors indicate cooler temperatures occurring at higher altitudes.

DISPLAYING CLOUD TOPS INFORMATION

- 1) Select the GFDS Weather Data Link Page.
- 2) Select the **IR SAT** Softkey.

To display the Infrared Satellite legend, select the **LEG-
END** Softkey when Infrared Satellite data is selected for display.

Datalink Lightning

Lightning data shows the approximate location of cloud-to-ground lightning strikes. A strike icon represents a strike that has occurred within a two-kilometer region. Neither cloud-to-cloud nor the exact location of the lightning strike is displayed.

If the aircraft is also equipped with an on-board lightning detection system (e.g., L-3 WX-500 Stormscope®), only one lightning product may be enabled for display at a time.

DISPLAYING DATALINK LIGHTNING INFORMATION

- 1) Select the **MAP** Softkey (for the PFD Inset Map, select the **INSET** Softkey). This step is not necessary on the GFDS Weather Data Link Page.
- 2) Select the **DL LTNG** Softkey.

To display the Datalink Lightning legend on the Weather Data Link Page, select the **LEGEND** Softkey when Datalink Lightning is selected for display.

SIGMETs and AIRMETs

The entire SIGMET or AIRMET is displayed as long as any portion of it is occurring within the coverage area of the GFDS data request.

DISPLAYING SIGMETs AND AIRMETs

- 1) Select the GFDS Weather Data Link Page.
- 2) Select the **SIG/AIR** Softkey.
- 3) To view the text of the SIGMET or AIRMET, press the **RANGE** Knob and move the Map Pointer over the icon.
- 4) Press the **ENT** key.

To display the SIGMET and AIRMET legend, select the **LEGEND** Softkey when SIGMETs and AIRMETs are selected for display.

METARs and TAFs



NOTE: METAR information is only displayed within the installed navigation database service area.

METAR and TAF text are displayed on the WPT-Weather Information Page. TAF information is displayed in its raw form when it is available.

DISPLAYING METAR AND TAF TEXT

- 1) On the GFDS Weather Data Link Page, select the **METAR** Softkey.
- 2) Press the **RANGE** Knob and pan to the desired airport.
- 3) Press the **ENT** Key. The Weather Information Page is shown with METAR and TAF text.
- 4) Use the **FMS** Knob or the **ENT** Key to scroll through the METAR and TAF text. METAR text must be completely scrolled through before scrolling through the TAF text.
- 5) Press the **FMS** Knob or the **CLR** Key to return to the GFDS Weather Data Link Page.

Or:

- 1) Select the Weather Information Page.
 - a) Turn the large **FMS** Knob to select the Waypoint Page Group.
 - b) Select the **WX** Softkey to select the Weather Information Page.
- 2) Press the **FMS** Knob to display the cursor.
- 3) Use the **FMS** Knob to enter the desired airport and press the **ENT** Key.
- 4) Use the **FMS** Knob or the **ENT** Key to scroll through the METAR and TAF text. Note that the METAR text must be completely scrolled through before scrolling through the TAF text.

To display the METAR legend on the GFDS Weather Data Link Page, select the **LEGEND** Softkey when METARs are selected for display.

Winds Aloft

Winds Aloft data shows the forecasted wind speed and direction at the surface and at selected altitudes. Altitude can be displayed in 3,000-foot increments up to 42,000 feet MSL.

DISPLAYING WINDS ALOFT DATA

- 1) Select the GFDS Weather Data Link Page.
- 2) Select the **MORE WX** Softkey.
- 3) Select the **WIND** Softkey.
- 4) Select the desired altitude level: SFC (surface) up to 42,000 feet. Select the **NEXT** or **PREV** Softkey to cycle through the altitude softkeys. The **WIND** Softkey label changes to reflect the altitude selected.

To display the Winds Aloft legend, select the **LEGEND** Softkey when Winds Aloft is selected for display.

PIREPs

Pilot Weather Reports (PIREPs) describe in-flight weather encountered by pilots. A PIREP may contain unforecast adverse weather conditions, such as low in-flight visibility, icing conditions, wind shear, turbulence, and type of aircraft flown. PIREPs are issued as either Routine (UA) or Urgent (UUA).

DISPLAYING PIREP TEXT

- 1) Select the GFDS Weather Data Link Page.
- 2) Select the **MORE WX** Softkey.
- 3) Select the **PIREPS** Softkey.
- 4) Press the **RANGE** Knob and pan to the desired weather report. A gray circle will appear around the weather report when it is selected.
- 5) Press the **ENT** Key. The PIREP text is first displayed in a decoded fashion, then as raw text.
- 6) Use the **FMS** Knob or the **ENT** Key to scroll through the PIREP text.
- 7) Press the **FMS** Knob or the **CLR** Key to close the PIREP text window and return to the GFDS Weather Data Link Page.

To display the PIREP or AIREP legend, select the **LEGEND** Softkey when PIREPs or AIREPs are selected for display.

The PIREP color is determined by the type (routine or urgent).

10.6 TRAFFIC SYSTEMS

- If Traffic information Service (TIS) is configured, a **STANDBY**, **OPERATE**, and **TNA MUTE** Softkey are displayed.
- If a Traffic Advisory System (TAS) is configured, a **STANDBY**, **NORMAL**, **TEST**, and **ALT MODE** Softkey are displayed.
- If an ADS-B traffic system is configured, only the **ALT MODE** Softkey is displayed.

Traffic Information Service (TIS)



NOTE: Traffic Information Service (TIS) is only available when the aircraft is within the service volume of a TIS capable terminal radar site.



NOTE: If the G1000 is configured to use a Traffic Advisory System (TAS), TIS is not available for use.

Displaying Traffic on the Traffic Map Page

- 1) Turn the large **FMS** Knob to select the 'MAP' page group.
- 2) Turn the small **FMS** Knob to select TRAFFIC MAP.
- 3) Press the **OPERATE** Softkey to begin displaying traffic. 'OPERATING' is displayed in the Traffic Mode field.
- 4) Press the **STANDBY** Softkey to place the system in the Standby Mode. 'STANDBY' is displayed in the Traffic Mode field.
- 5) Rotate the **Joystick** clockwise to display a larger area or rotate counter-clockwise to display a smaller area.

If data is not received for a period longer than 6 seconds, the age of the present data is displayed in the lower left of the screen along with the annunciation that the system has entered Coast Mode. The system maintains

the traffic display (up to 60 seconds) until the next data reception. If no data is received after 60 seconds, traffic is removed from the display.

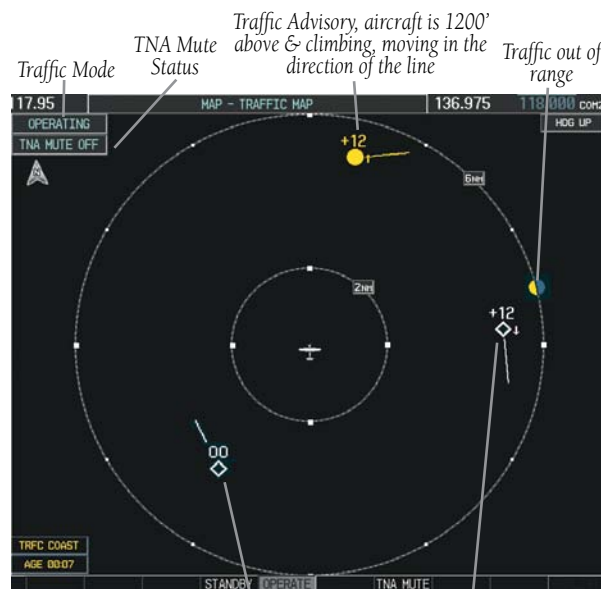

Last data update is older than 6 sec. resulting in Coast Mode
 Traffic at same altitude, level flight & moving in the direction of the line
 Proximity Traffic 1200' above & descending, moving in the direction of the line

Figure 10-30 Traffic Map Page

Displaying Traffic on the Navigation Map

- 1) Ensure TIS is operating. With the Navigation Map displayed, press the **MAP** Softkey.
- 2) Press the **TRAFFIC** Softkey. Traffic is now displayed on the map.

TIS Voice Alert

When a Traffic Advisory (TA) is displayed, a voice alert "Traffic" is given.

"Traffic Not Available" is heard whenever TIS service becomes unavailable. This alert can be muted by pressing the **TNA MUTE** Softkey. 'TNA MUTE ON' is displayed in the upper left of the display.

Traffic Advisory Systems (Optional)

GTS 800 Traffic System (Optional)

Testing the Traffic System:

- 1) Turn the large **FMS** Knob to select the Map Page Group.
- 2) Turn the small **FMS** Knob to select the Traffic Map Page.
- 3) Turn the **Range** knob to set the range to 2/6 nm to allow for proper test pattern display.
- 4) Press the **TEST** Softkey.

Or:

- 1) Press the **MENU** Key and turn the small **FMS** knob to select 'Test Mode'.
- 2) Press the **ENT** Key.



TA at 9 o'clock, Distance 2.0 nm, 200' Below, Climbing
 Proximity Traffic at 1 o'clock, Distance 3.6 nm, 1000' Below, Descending

Figure 10-31 Test Mode

Displaying traffic on the Traffic Map Page:

- 1) Turn the large **FMS** Knob to select the Map Page Group.
- 2) Turn the small **FMS** Knob to select the Traffic Map Page.
- 3) Press the **OPERATE** Softkey to begin displaying traffic. OPERATING is displayed in the Traffic mode field.
- 4) Press the **STANDBY** Softkey to place the system in the Standby mode. STANDBY is displayed in the Traffic Mode field.
- 5) Turn the **RANGE** Knob clockwise to display a larger area or counter-clockwise to display a smaller area.

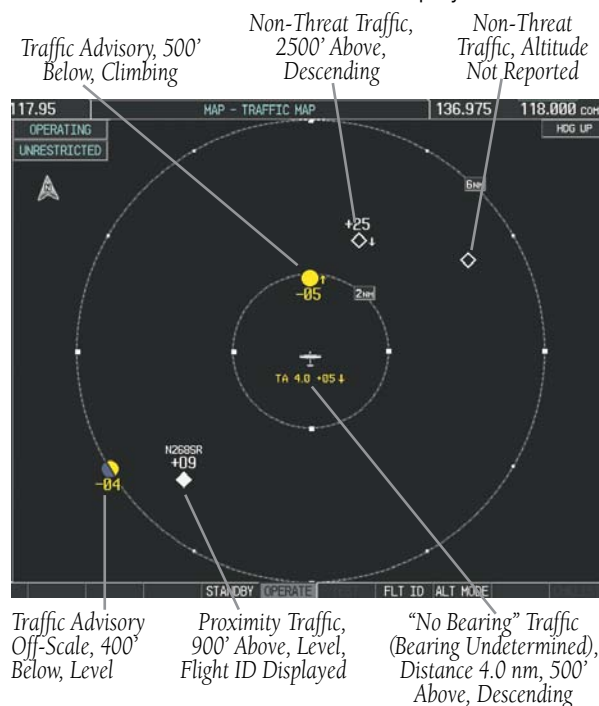

Figure 10-32 Traffic Map

Displaying Traffic on the Navigation Map

- 1) Ensure TIS is operating. With the Navigation Map displayed, press the **MAP** Softkey.
- 2) Press the **TRAFFIC** Softkey. Traffic is now displayed on the map.

Switching from operating mode to standby mode:

On the Traffic Page, press the **STANDBY** Softkey

Or:

- 1) Press the **MENU** Key and turn the small **FMS** knob to select 'Standby Mode'.
- 2) Press the **ENT** Key.

ALTITUDE DISPLAY

The pilot can select the volume of airspace in which non-threat and proximity traffic is displayed. TAs occurring outside of these limits will always be shown.

Changing the altitude range:

- 1) On the Traffic Map Page, press the **ALT MODE** Softkey.
- 2) Press one of the following Softkeys:
 - **ABOVE:** Displays non-threat and proximity traffic from 9000 feet above the aircraft to 2700 feet below the aircraft. Typically used during climb phase of flight.
 - **NORMAL:** Displays non-threat and proximity traffic from 2700 feet above the aircraft to 2700 feet below the aircraft. Typically used during enroute phase of flight.
 - **BELOW:** Displays non-threat and proximity traffic from 2700 feet above the aircraft to 9000 feet below the aircraft. Typically used during descent phase of flight.

- **UNREST** (unrestricted): All traffic is displayed from 9900 feet above and 9900 feet below the aircraft.
- 3) To return to the Traffic Map Page, press the **BACK** Softkey.

Or:

- 1) Press the **MENU** Key.
- 2) Turn the small **FMS** Knob to select one of the following (see Softkey description in previous step)
 - ABOVE
 - NORMAL
 - BELOW
 - UNRESTRICTED
- 3) Press the **ENT** Key.

Flight ID Display

The Flight IDs of other aircraft (when available) can be enabled for display on the Traffic Map Page. When a flight ID is received, it will appear above or below the corresponding traffic symbol on the Traffic Map Page when this option is enabled.

Enabling/Disabling Flight ID Display:

On the Traffic Map Page, press the **FLT ID** Softkey.

Or:

- 1) Press the **MENU** Key.
- 2) Turn the small **FMS** Knob to select 'Show Flight IDs' or 'Hide Flight IDs' (choice dependent on current state) (Figure 6-92).
- 3) Press the **ENT** Key.

KTA 870 Traffic System (Optional)

Refer to the Honeywell KTA 870 Pilot's Guide for a detailed discussion of the KTA 870 system.

System Self Test

- 1) Set the range to 2/6 nm.
- 2) Press the **STANDBY** Softkey.
- 3) Press the **TEST** Softkey.
- 4) Self test takes approximately eight seconds to complete. When completed successfully, traffic symbols are displayed as shown in Figure 10-12 and a voice alert "TAS System Test OK" is heard. If the self test fails, the system reverts to Standby Mode and a voice alert "TAS System Test Fail" is heard.



Figure 10-33 Self Test OK Display

Displaying Traffic on the Traffic Map Page

- 1) Turn the large **FMS** Knob to select the 'MAP' page group.
- 2) Turn the small **FMS** Knob to select TRAFFIC MAP.
- 3) Press the **NORMAL** Softkey to begin displaying traffic. 'OPERATING' is displayed in the Traffic Mode field.

- 4) Press the **ALT MODE** Softkey to change the altitude volume. Select the desired altitude volume by pressing the **BELOW**, **NORMAL**, **ABOVE**, or **UNREST** (unrestricted) Softkey. The selection is displayed in the Altitude Mode field.
- 5) Press the **STANDBY** Softkey to place the system in the Standby Mode. 'STANDBY' is displayed in the Traffic Mode field.
- 6) Rotate the **Joystick** clockwise to display a larger area or rotate counter-clockwise to display a smaller area.

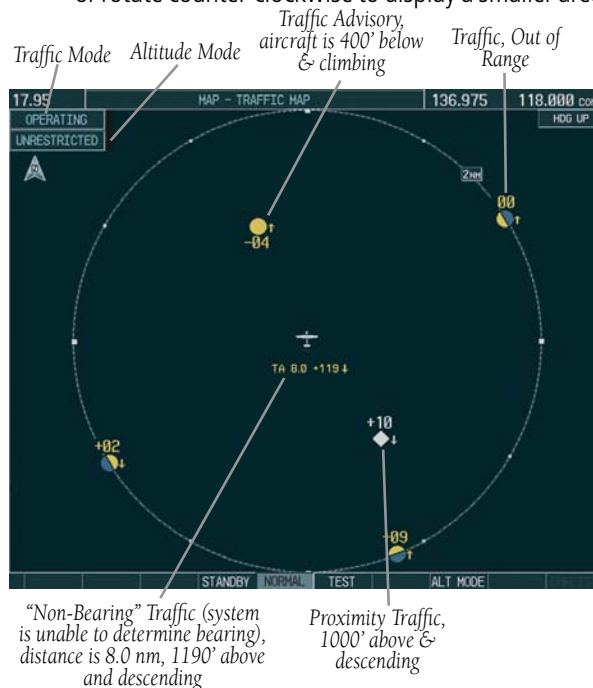

Figure 10-34 Traffic Map Page

Displaying Traffic on the Navigation Map

- 1) Ensure the KTA 870 system is operating. With the Navigation Map displayed, press the **MAP** Softkey.
- 2) Press the **TRAFFIC** Softkey. Traffic is now displayed on the map.

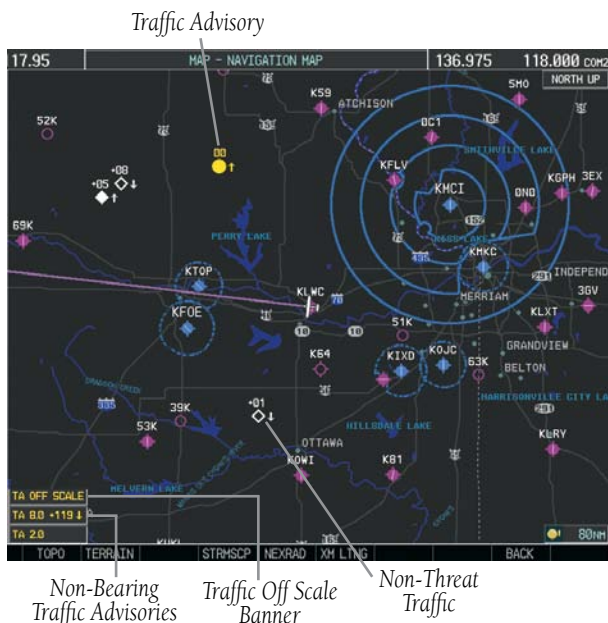

Figure 10-35 TAS Traffic on Navigation Map

ADS-B Traffic GDL 90 (Optional)

ADS-B is limited to displaying traffic in the G1000. Operation is similar to the TAS system discussed previously, with the exception of symbology. The following traffic symbols are used to display traffic with the ADS-B system.

Symbol	Description
	Traffic Advisory with directional information. Points in the direction of the intruder aircraft track. (GDL 90 and GTS 800)
	Traffic Advisory without directional information. (GDL 90 and GTS 800)
	Traffic Advisory out of the selected display range. Displayed at outer range ring at proper bearing. (GDL 90 and GTS 800)
	Non-threat traffic with directional information. Points in the direction of the aircraft track. (GDL 90 and GTS 800)

Symbol	Description
	Non-threat traffic with no directional information. (GDL 90 and GTS 800)
	Traffic located on the ground with directional information. Points in the direction of the aircraft track. Ground traffic is only displayed when own aircraft is below 1,000 feet AGL or on the ground. (GDL 90 only)
	Ground traffic without directional information. Ground traffic is only displayed when own aircraft is below 1,000 feet AGL or on the ground. (GDL 90 only)
	Non-aircraft ground traffic. Ground traffic is only displayed when own aircraft is below 1,000 feet AGL or on the ground. (GDL 90 only)
	Traffic with directional information, but positional accuracy is degraded. Points in the direction of the aircraft track. (GDL 90 and GTS 800)

Table 10-7

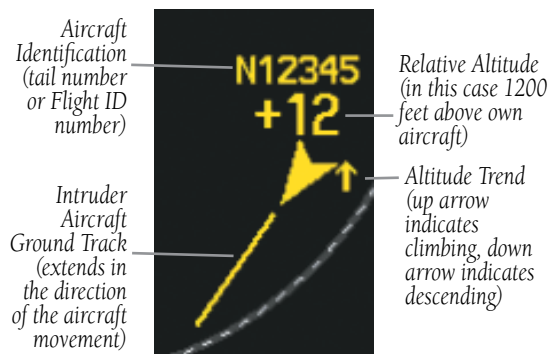

Figure 10-36 Example ADS-B Traffic Advisory

10.7 TERRAIN AND OBSTACLE PROXIMITY



NOTE: Terrain data is not displayed when the aircraft is outside the installed terrain database coverage area.

Displaying Terrain and Obstacles on the Terrain Proximity Page

- 1) Turn the large **FMS** Knob to select the 'MAP' page group.
- 2) Turn the small **FMS** Knob to select TERRAIN PROXIMITY.
- 3) If desired, press the **VIEW** Softkey to access the **ARC** and **360** Softkeys. When the **ARC** Softkey is pressed, a radar-like 120° view is displayed. Press the **360** Softkey to return to the 360° default display.
- 4) Rotate the **Joystick** clockwise to display a larger area or rotate counter-clockwise to display a smaller area.

Color	Indication
RED	Terrain/Obstacle above or within 100' below current aircraft altitude.
YELLOW	Terrain/Obstacle between 100' and 1000' below current aircraft altitude.

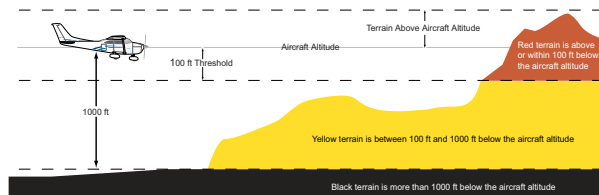





Unlighted Obstacle (Height is less than 1000' AGL)	Lighted Obstacle (Height is less than 1000' AGL)	Unlighted Obstacle (Height is greater than 1000' AGL)	Lighted Obstacle (Height is greater than 1000' AGL)
			

Figure 10-38 Obstacle Symbols

Displaying Terrain and Obstacles on the Navigation Map

- 1) With the Navigation Map displayed, press the **MAP** Softkey.
- 2) Press the **TERRAIN** Softkey. Terrain and obstacle proximity is now displayed on the map.
- 3) Terrain and obstacles may be displayed in the Profile View by selecting the **PROFILE** Softkey.

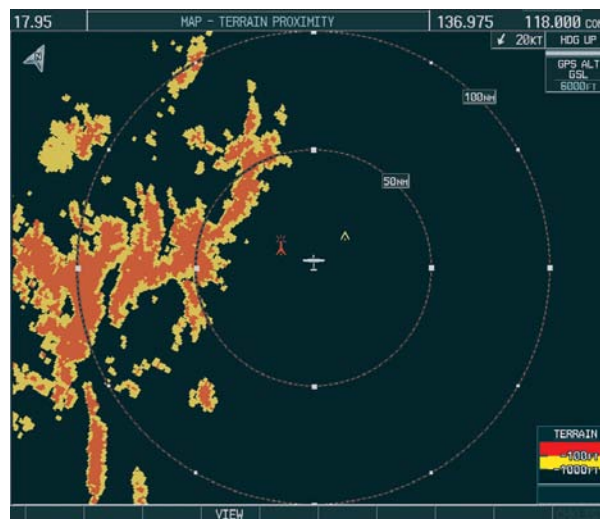

Figure 10-37 Terrain Proximity Page

10.8 TERRAIN-SVS DISPLAY (OPTIONAL)



NOTE: Terrain data is not displayed when the aircraft is outside the installed terrain database coverage area.



NOTE: TERRAIN-SVS operation is only available when the Synthetic Vision System is installed. TAWS will take precedence over TERRAIN-SVS when installed.

Displaying Terrain on the TERRAIN-SVS Page

- 1) Turn the large **FMS** Knob to select the 'MAP' page group.
- 2) Turn the small **FMS** Knob to select the TERRAIN-SVS Page.
- 3) If desired, press the **VIEW** Softkey to access the **ARC** and **360** Softkeys. When the **ARC** Softkey is pressed, a radar-like 120° view is displayed. Press the **360** Softkey to return to the 360° default display.
- 4) Rotate the **Joystick** clockwise to display a larger area or rotate counter-clockwise to display a smaller area.

Color	Terrain/Obstacle Location
Red	Terrain/Obstacle above or within 100' below current aircraft altitude.
Yellow	Terrain/Obstacle between 100' and 1000' below current aircraft altitude.
Black	Terrain/Obstacle is more than 1000' below aircraft altitude.

Table 10-7

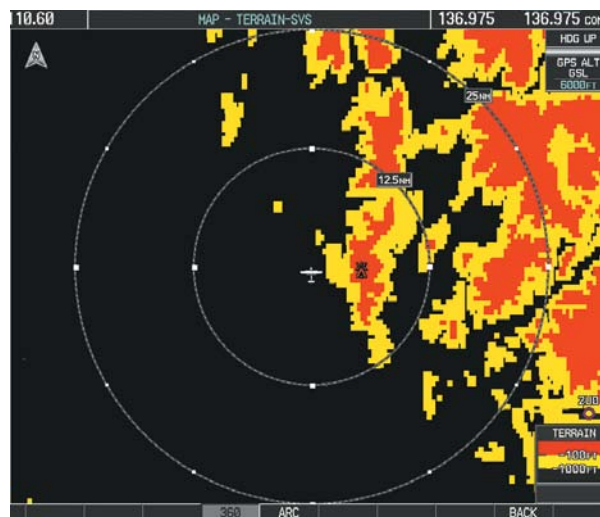

Figure 10-39 Terrain-SVS Page (360° View)

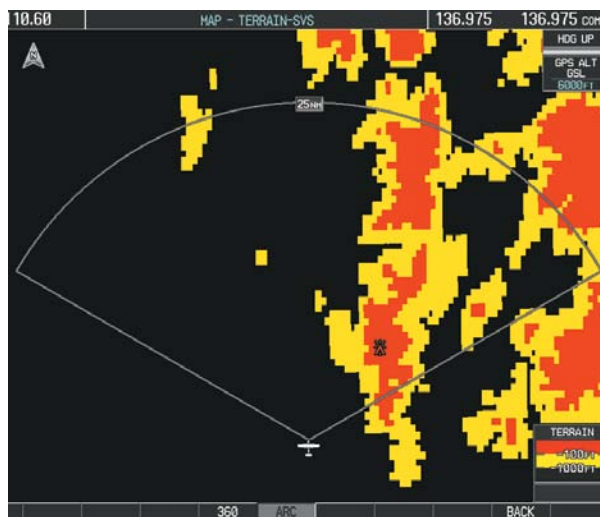

Figure 10-40 Terrain-SVS Page (ARC View)

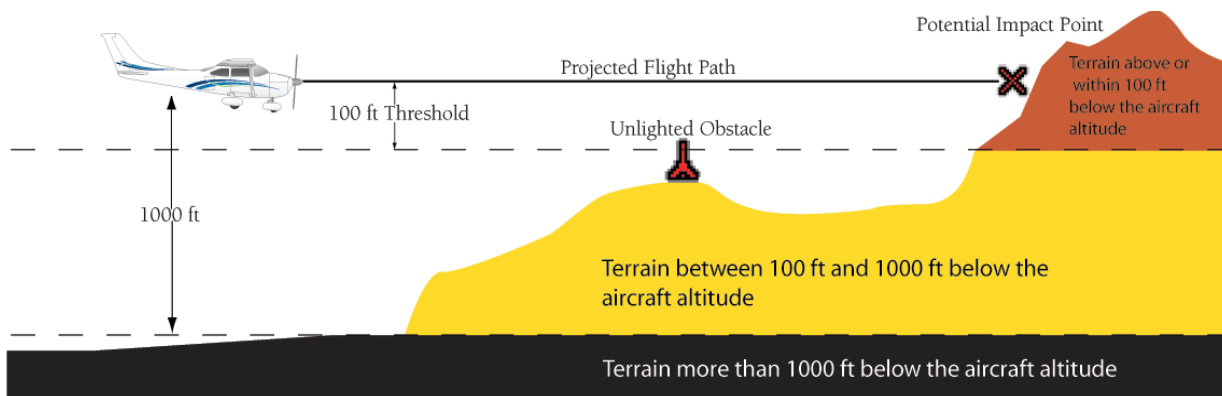

Figure 10-41 Terrain-Color Code

Enable/Disable Aviation Data

- 1) While the TERRAIN-SVS Page is displayed, press the **MENU** Key.
- 2) Turn the small **FMS** Knob to select "Show (or Hide) Aviation Data".
- 3) Press the **ENT** Key.

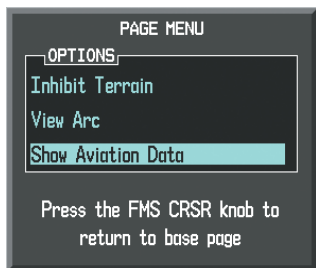

Figure 10-42 Terrain-SVS Page Menu

TERRAIN-SVS Alerts

Alerts are issued when flight conditions meet parameters that are set within TERRAIN-SVS software algorithms. TERRAIN-SVS alerts typically employ a CAUTION or a WARNING alert severity level, or both. When an alert is issued, visual annunciations are displayed and aural alerts are simultaneously issued. The following tables show TERRAIN-SVS alert types with corresponding annunciations and aural messages and system status annunciations.

When an alert is issued, annunciations appear on the PFD and MFD. The TERRAIN-SVS Alert Annunciation is shown to the upper left of the Altimeter on the PFD and below the Terrain Legend on the MFD. If the TERRAIN-SVS Page is not displayed at the time, a pop-up alert appears on the MFD. To acknowledge the pop-up alert:

- Press the **CLR** Key (returns to the currently viewed page), or
- Press the **ENT** Key (accesses the TERRAIN-SVS Page)

Alert Type	PFD/MFD Alert Annunciation	MFD Pop-Up Alert	Aural Message
Reduced Required Terrain Clearance Warning (RTC)	TERRAIN	WARNING - TERRAIN	"Warning; Terrain, Terrain"
Imminent Terrain Impact Warning (ITI)	TERRAIN	WARNING - TERRAIN	"Warning; Terrain, Terrain"
Reduced Required Obstacle Clearance Warning (ROC)	TERRAIN	WARNING - OBSTACLE	"Warning; Obstacle, Obstacle"
Imminent Obstacle Impact Warning (IOI)	TERRAIN	WARNING - OBSTACLE	"Warning; Obstacle, Obstacle"
Reduced Required Terrain Clearance Caution (RTC)	TERRAIN	CAUTION - TERRAIN	"Caution; Terrain, Terrain"
Imminent Terrain Impact Caution (ITI)	TERRAIN	CAUTION - TERRAIN	"Caution; Terrain, Terrain"
Reduced Required Obstacle Clearance Caution (ROC)	TERRAIN	CAUTION - OBSTACLE	"Caution; Obstacle, Obstacle"
Imminent Obstacle Impact Caution (IOI)	TERRAIN	CAUTION - OBSTACLE	"Caution; Obstacle, Obstacle"

Table 10-8

Alert Type	PFD/MFD Alert Annunciation	TERRAIN-SVS Page Annunciation	Aural Message
System Test in Progress	TER TEST	TERRAIN TEST	None
System Test Pass	None	None	"Terrain System Test OK"
Terrain Alerting is disabled	TER INH	None	None
MFD Terrain or Obstacle database unavailable or invalid. Terrain-SVS operating with PFD Terrain or Obstacle databases	None	TERRAIN DATABASE FAILURE	None
Terrain System Test Fail	TER FAIL	TERRAIN FAIL	"Terrain System Failure"
Terrain or Obstacle database unavailable or invalid, invalid software configuration, system audio fault	TER FAIL	TERRAIN FAIL	"Terrain System Failure"
No GPS position	TER N/A	NO GPS POSITION	"Terrain System Not Available"
Excessively degraded GPS signal, Out of database coverage area	TER N/A	None	"Terrain System Not Available"
Sufficient GPS signal received after loss	None	None	"Terrain System Available"

Table 10-9

SECTION 10 – HAZARD AVOIDANCE

Alert Annunciation

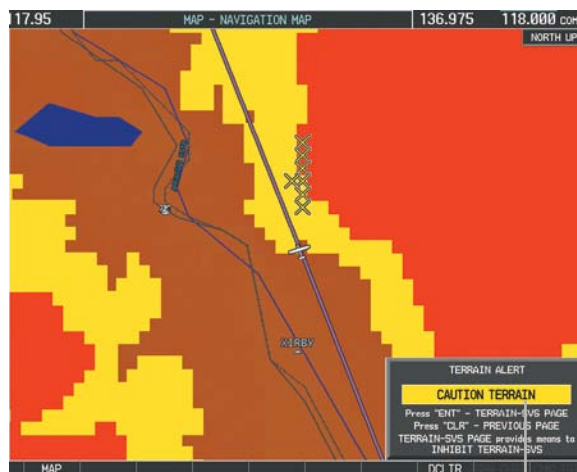
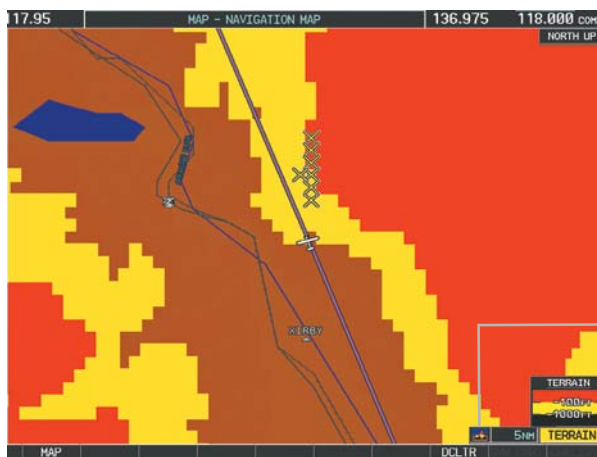

Figure 10-43 TERRAIN-SVS Alert Annunciations

Pop-up Alert



Terrain Display Enabled

Terrain Legend

Alert Annunciation

Figure 10-44 Navigation Map Page (After TERRAIN-SVS Pop-up Alert Acknowledgment)

Terrain Inhibit

Flying VFR into an area where unique terrain exists could cause the system to announce a nuisance alert.

Inhibit TERRAIN-SVS:

While the TERRAIN-SVS Page is displayed, press the **INHIBIT** Softkey. 'TER INHB' is annunciated in the lower right of portion of the screen.

Enable TERRAIN-SVS:

If TERRAIN-SVS has been inhibited, from the TERRAIN-SVS Page press the **INHIBIT** Softkey. The 'TER INHB' annunciation is removed.



NOTE: If TERRAIN-SVS alerts are inhibited when the Final Approach Fix is the active waypoint in a GPS SBAS approach, a LOW ALT annunciation may appear on the PFD next to the altimeter if the current aircraft altitude is at least 164 feet below the prescribed altitude at the Final Approach Fix.

Forward Looking Terrain Avoidance (FLTA)

The Forward Looking Terrain Avoidance alert is composed of two sub-functions:

Reduced Required Terrain Clearance (RTC) and Reduced Required Obstacle Clearance (ROC)

This provides alerts when the aircraft flight path is above terrain and/or obstacles, yet is projected to come within minimum clearance values outlined in the following table.

Reduced Required Terrain Clearance (RTC) and Reduced Required Obstacle Clearance (ROC)

This provides alerts when the aircraft flight path is above terrain and/or obstacles, yet is projected to come within minimum clearance values outlined in the following table. When an RTC or ROC alert is issued, a potential impact point is displayed on the TERRAIN-SVS Page as a yellow or red 'X'.

Imminent Terrain Impact (ITI) and Imminent Obstacle Impact (IOI)

This provides alerts when the aircraft is below the elevation of terrain in the aircraft's projected path. ITI and IOI alerts are accompanied by a potential impact point displayed on the TERRAIN-SVS Page as a yellow or red 'X'. The alert is given when the projected vertical flight path is calculated to come within minimum clearance altitudes in the following table.

Phase of Flight	Level Flight	Descending
Enroute	700 ft.	500 ft.
Terminal	350 ft.	300 ft.
Approach	150 ft.	100 ft.
Departure	100 ft.	100 ft.

Table 10-10

During the final approach phase of flight, RTC/ROC/ITI/IOI alerts are automatically inhibited when the aircraft is below 200 feet AGL while within 0.5 nm of the approach runway or is below 125 feet AGL while within 1 nm of the runway.

Unlighted Obstacle (Height is less than 1000' AGL)	Lighted Obstacle (Height is less than 1000' AGL)	Unlighted Obstacle (Height is greater than 1000' AGL)	Lighted Obstacle (Height is greater than 1000' AGL)	Potential Impact Points

Figure 10-45 Terrain-SVS Symbols

Displaying Terrain and Obstacles on the Navigation Map

- 1) With the Navigation Map displayed, press the **MAP** Softkey.
- 2) Press the **TERRAIN** Softkey. Terrain and obstacle proximity are now displayed on the map.
- 3) Terrain and obstacles may be displayed in the Profile View by selecting the **PROFILE** Softkey.

10.9 TERRAIN AWARENESS & WARNING SYSTEM (TAWS) DISPLAY (OPTIONAL)



NOTE: Terrain data is not displayed when the aircraft latitude is greater than 75 degrees north or 60 degrees south.



NOTE: TAWS operation is only available when the G1000 is configured for a TAWS-B installation.

Displaying Terrain on the TAWS-B Page

- 1) Turn the large **FMS** Knob to select the 'MAP' page group.
- 2) Turn the small **FMS** Knob to select the TAWS-B Page.
- 3) If desired, press the **VIEW** Softkey to access the **ARC** and **360** Softkeys. The **ARC** Softkey provides a radar-like 120° view. Press the **360** Softkey to return to the 360° default display.
- 4) Rotate the **Joystick** clockwise to display a larger area or rotate counter-clockwise to display a smaller area.

Color	Terrain/Obstacle Location
Red	Terrain/Obstacle above or within 100' below current aircraft altitude.
Yellow	Terrain/Obstacle between 100' and 1000' below current aircraft altitude.
Black	Terrain/Obstacle is more than 1000' below aircraft altitude.

Table 10-11

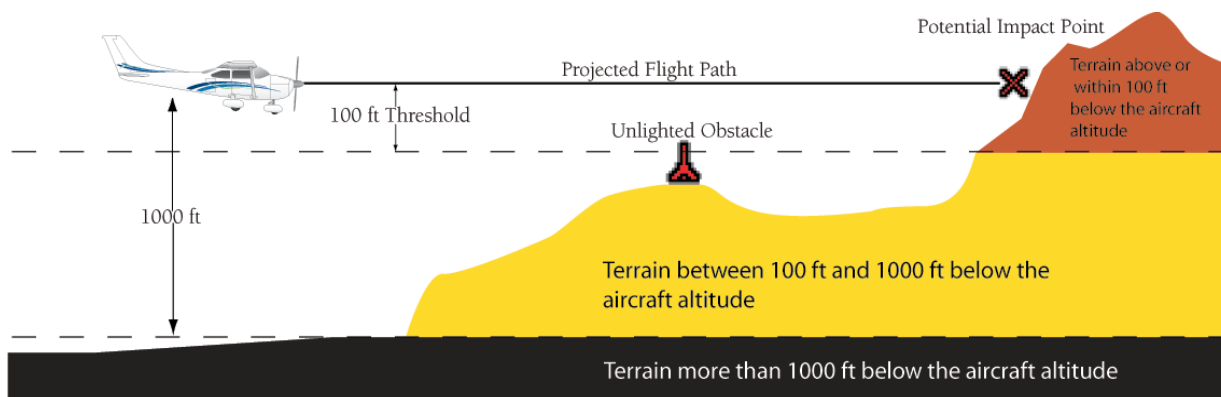

Figure 10-46 Terrain-Color Code

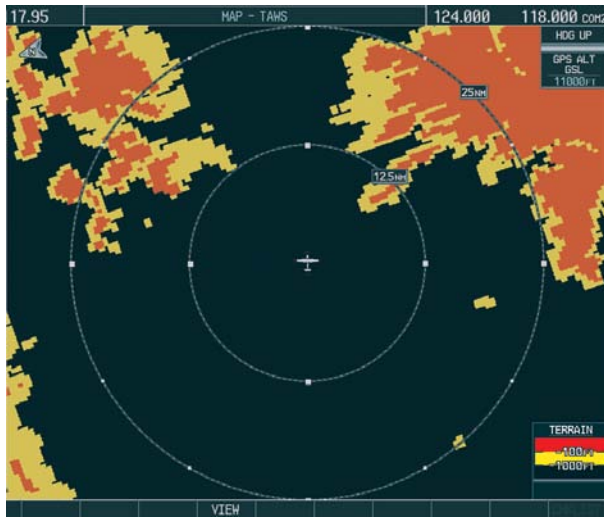

Figure 10-47 TAWS-B Page (360° View)

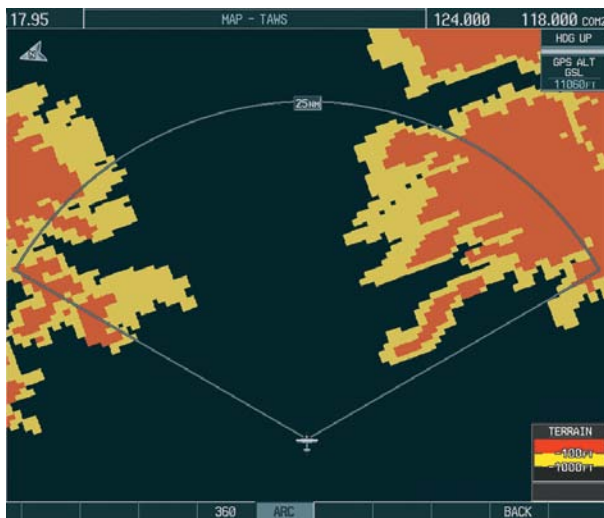

Figure 10-48 TAWS-B Page (ARC View)

Enable/Disable Aviation Data

- 1) While the TAWS-B Page is displayed, press the **MENU** Key.
- 2) Turn the small **FMS** Knob to select "Show (or Hide) Aviation Data".
- 3) Press the **ENT** Key.

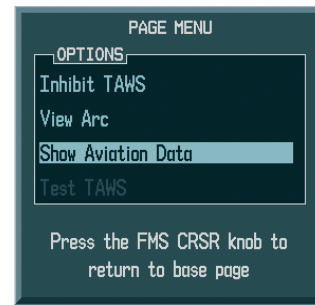

Figure 10-49 TAWS-B Page Menu

TAWS Inhibit

Flying VFR into an area where unique terrain exists could cause the system to annunciate a nuisance alert. When TAWS is inhibited, only FLTA and PDA alerts are disabled.

Inhibit TAWS:

While the TAWS-B Page is displayed, press the **INHIBIT** Softkey. 'TAWS INHB' is annunciated in the lower right of portion of the screen.

Enable TAWS:

If TAWS has been inhibited, from the TAWS-B Page press the **INHIBIT** Softkey. The 'TAWS INHB' annunciation is removed.



NOTE: If TAWS alerts are inhibited when the Final Approach Fix is the active waypoint in a GPS SBAS approach, a **LOWALT** annunciation may appear on the PFD next to the altimeter if the current aircraft altitude is at least 164 feet below the prescribed altitude at the Final Approach Fix.

Manual System Test

A system test is automatically performed at power-up. After successful completion of the test, "TAWS System Test, OK" is heard.

The system test may also be initiated manually, but only when the aircraft is on the ground. To manually verify proper operation of the aural and visual annunciations of the system, perform the following steps.

- 1) While the TAWS-B Page is displayed, press the **MENU** Key.
- 2) Turn the small **FMS** Knob to select 'Test TAWS'.
- 3) Press the **ENT** Key. During the test 'TAWS TEST' is displayed in the center of the TAWS-B Page.

When all is in working order, "TAWS System Test, OK" is heard.

Forward Looking Terrain Avoidance (FLTA)

The Forward Looking Terrain Avoidance alert is composed of two sub-functions:

Reduced Required Terrain Clearance (RTC) and Reduced Required Obstacle Clearance (ROC)

This provides alerts when the aircraft flight path is above terrain and/or obstacles, yet is projected to come within minimum clearance values outlined in the following table. When an RTC or ROC alert is issued, a potential impact point is displayed on the TAWS-B Page as a yellow or red 'X'.

Imminent Terrain Impact (ITI) and Imminent Obstacle Impact (IOI)

This provides alerts when the aircraft is below the elevation of terrain in the aircraft's projected path. ITI and IOI alerts are accompanied by a potential impact point displayed on the TAWS-B Page as a yellow or red 'X'. The alert is given when the projected vertical flight path is calculated to come within minimum clearance altitudes in the following table.

Phase of Flight	Level Flight	Descending
Enroute	700 ft.	500 ft.
Terminal	350 ft.	300 ft.
Approach	150 ft.	100 ft.
Departure	100 ft.	100 ft.

Table 10-12

During the final approach phase of flight, RTC/ROC/ITI/IOI alerts are automatically inhibited when the aircraft is below 200 feet AGL while within 0.5 nm of the approach runway or is below 125 feet AGL while within 1 nm of the runway.

Premature Descent Alert (PDA)

A Premature Descent Alert is issued when the system detects that the aircraft is significantly below the normal approach path to a runway. The PDA alert mode functions only during descent to land.

PDA alerting begins when the aircraft is within 15 nm of the destination airport and ends when the aircraft is either 0.5 nm from the runway threshold OR is at an altitude of 125 feet AGL while within 1 nm of the threshold. During the final descent, algorithms set a threshold for alerting based on speed, distance, and other parameters.

Excessive Descent Rate Alert (EDR)

The purpose of the Excessive Descent Rate alert is to provide suitable alerts when the aircraft is determined to be closing (descending) upon terrain at an excessive speed. EDR alerts have two levels of severity, caution (sink rate) and warning (pull-up).

Negative Climb Rate After Takeoff Alert (NCR)

The purpose of the Negative Climb Rate After Takeoff alert is to provide suitable alerts to the pilot when the system determines that the aircraft is losing altitude (closing upon terrain) after takeoff. The aural message "Don't Sink" is given for NCR alerts, accompanied by an annunciation and a pop-up terrain alert on the display.

“Five-Hundred” Aural Alert

The purpose of the aural alert message “Five-hundred” is to provide an advisory alert to the air crew that the aircraft is five-hundred feet above terrain. When the aircraft descends within 500 feet of terrain, the aural message “Five-hundred” is heard. There are no display annunciations or pop-up alerts that accompany the aural message.

Displaying Terrain and Obstacles on the Navigation Map

- 1) With the Navigation Map displayed, press the **MAP** Softkey.
- 2) Press the **TERRAIN** Softkey. Terrain and obstacle proximity are now displayed on the map.
- 3) Terrain and obstacles may be displayed in the Profile View by selecting the **PROFILE** Softkey.

Pop-up Alerts

When a terrain or obstacle alert is issued, a pop-up window is displayed on the MFD with the appropriate alert.

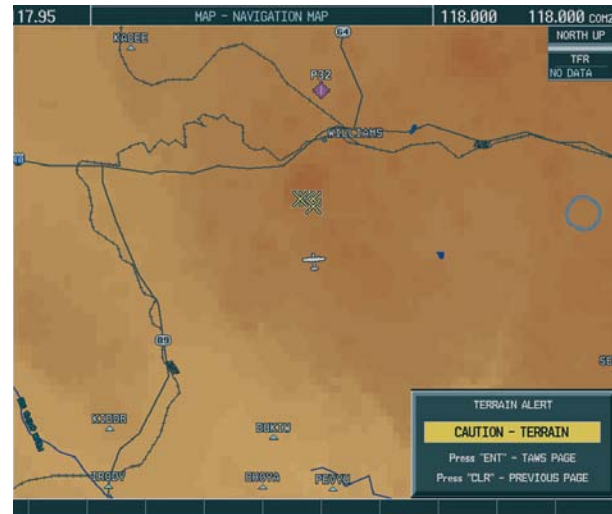

Figure 10-50 TAWS Alert Pop-Up

Press the **ENT** Key to display the TAWS-B Page, or press the **CLR** Key to remain on the existing page.

Unlighted Obstacle (Height is less than 1000' AGL)	Lighted Obstacle (Height is less than 1000' AGL)	Unlighted Obstacle (Height is greater than 1000' AGL)	Lighted Obstacle (Height is greater than 1000' AGL)	Potential Impact Points

Figure 10-51 TAWS Symbols

TAWS Alerts Summary

The following table shows the possible TAWS alert types with corresponding annunciations and aural messages.

Alert Type	PFD/MFD TAWS-B Page Annunciation	MFD Pop-Up Alert	Aural Message
Excessive Descent Rate Warning (EDR)	PULL UP	PULL-UP	"Pull Up"
Reduced Required Terrain Clearance Warning (RTC)	PULL UP	TERRAIN - PULL-UP or TERRAIN AHEAD - PULL-UP	"Terrain, Terrain; Pull Up, Pull Up" or "Terrain Ahead, Pull Up; Terrain Ahead, Pull Up"
Imminent Terrain Impact Warning (ITI)	PULL UP	TERRAIN AHEAD - PULL-UP or TERRAIN - PULL-UP	"Terrain Ahead, Pull Up; Terrain Ahead, Pull Up" or "Terrain, Terrain; Pull Up, Pull Up"
Reduced Required Obstacle Clearance Warning (ROC)	PULL UP	OBSTACLE - PULL-UP or OBSTACLE AHEAD - PULL-UP	"Obstacle, Obstacle; Pull Up, Pull Up" or "Obstacle Ahead, Pull Up; Obstacle Ahead, Pull Up"
Imminent Obstacle Impact Warning (IOI)	PULL UP	OBSTACLE AHEAD - PULL-UP or OBSTACLE - PULL-UP	"Obstacle Ahead, Pull Up; Obstacle Ahead, Pull Up" or "Obstacle, Obstacle; Pull Up, Pull Up"
Reduced Required Terrain Clearance Caution (RTC)	TERRAIN	CAUTION - TERRAIN or TERRAIN AHEAD	"Caution, Terrain; Caution, Terrain" or "Terrain Ahead; Terrain Ahead"
Imminent Terrain Impact Caution (ITI)	TERRAIN	TERRAIN AHEAD or CAUTION - TERRAIN	"Terrain Ahead; Terrain Ahead" or "Caution, Terrain; Caution, Terrain"
Reduced Required Obstacle Clearance Caution (ROC)	TERRAIN	CAUTION - OBSTACLE or OBSTACLE AHEAD	"Caution, Obstacle; Caution, Obstacle" or "Obstacle Ahead; Obstacle Ahead"
Imminent Obstacle Impact Caution (IOI)	TERRAIN	OBSTACLE AHEAD or CAUTION - OBSTACLE	"Obstacle Ahead; Obstacle Ahead" or "Caution, Obstacle; Caution, Obstacle"
Premature Descent Alert Caution (PDA)	TERRAIN	TOO LOW - TERRAIN	"Too Low, Terrain"
Altitude Callout "500"	None	None	"Five-Hundred"
Excessive Descent Rate Caution (EDR)	TERRAIN	SINK RATE	"Sink Rate"
Negative Climb Rate Caution (NCR)	TERRAIN	DON'T SINK or TOO LOW - TERRAIN	"Don't Sink" or "Too Low, Terrain"

Table 10-10

The following system status annunciations may also be issued.

Alert Type	PFD/MFD Alert Annunciation	TERRAIN-SVS Page Annunciation	Aural Message
System Test in Progress	TAWS TEST	TAWS TEST	None
System Test Pass	None	None	"TAWS System Test OK"
TAWS Alerting is disabled	TAWS INH	None	None
MFD Terrain or Obstacle database unavailable or invalid. TAWS operating with PFD Terrain or Obstacle databases	None	TERRAIN DATABASE FAILURE	None
TAWS-B System Test Fail	TAWS FAIL	TAWS FAIL	"TAWS System Failure"
Terrain or Obstacle database unavailable or invalid, invalid software configuration, system audio fault	TAWS FAIL	TAWS FAIL	"TAWS System Failure"
No GPS position	TAWS N/A	NO GPS POSITION	"TAWS Not Available"
Excessively degraded GPS signal, Out of database coverage area	TAWS N/A	None	"TAWS Not Available"
Sufficient GPS signal received after loss	None	None	"TAWS Available"

Table 10-11

Alert Annunciations

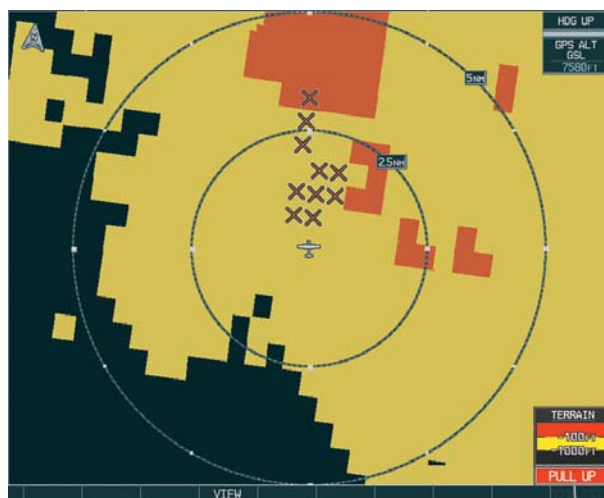

Alert Annunciation

Figure 10-52 Alert Annunciation on the TAWS-B Page



Figure 10-53 TAWS Alert Annunciation on the PFD

Blank Page

SECTION 11: ADDITIONAL FEATURES

11.1 SYNTHETIC VISION SYSTEM (SVS) (OPTIONAL)



WARNING: Use appropriate primary systems for navigation, and for terrain, obstacle, and traffic avoidance. SVS is intended as an aid to situational awareness only and may not provide either the accuracy or reliability upon which to solely base decisions and/or plan maneuvers to avoid terrain, obstacles, or traffic.

The optional Synthetic Vision System depicts a forward-looking attitude display of the topography immediately in front of the aircraft. The field of view is 30 degrees to the left and 35 degrees to the right. The depicted imagery is derived from the aircraft attitude, heading, GPS three-dimensional position, and a nine arc-second database of terrain, obstacles, and other relevant features. Loss of any of the required data, including temporary loss of the GPS signal, will cause SVS to be disabled until the required data is restored.

The SVS terrain display shows land contours (colors are consistent with those of the topographical map display), large water features, towers, and other obstacles over 200' AGL that are included in the obstacle database. Cultural features on the ground such as roads, highways, railroad tracks, cities, and state boundaries are not displayed even if those features are found on the MFD map. The terrain display also includes a north-south east-west grid with lines oriented with true north and spaced at one arc-minute intervals to assist in orientation relative to the terrain.

The optional Terrain Awareness and Warning System (TAWS) or standard Terrain-SVS is integrated within SVS to provide visual and auditory alerts to indicate the presence of terrain and obstacle threats relevant to the projected

flight path. Terrain alerts are displayed in red and yellow shading on the PFD.

The terrain display is intended for situational awareness only. It may not provide the accuracy or fidelity on which to base decisions and plan maneuvers to avoid terrain or obstacles. Navigation must not be predicated solely upon the use of the Terrain-SVS or TAWS terrain or obstacle data displayed by the SVS.



Figure 11-1 Synthetic Vision Imagery

SVS Operation

SVS is activated from the PFD using the softkeys located along the bottom edge of the display. Pressing the softkeys turns the related function on or off. When SVS is enabled, the pitch ladder increments are reduced to 10 degrees up and 7.5 degrees down.

SVS functions are displayed on three levels of softkeys. The **PFD** Softkey leads into the PFD function Softkeys, including synthetic vision. Pressing the **SYN VIS** Softkey displays the SVS feature softkeys. The softkeys are labeled **PATHWAY**, **SYN TERR**, **HRZN HDG**, and **APTSIGNS**. The **BACK** Softkey returns to the previous level of softkeys. Synthetic Terrain must be active before any other SVS feature may be activated.

HRZN HDG, **APTSIGNS**, and **PATHWAY** Softkeys are only available when the **SYN TERR** Softkey is activated (gray with black characters). After activating the **SYN TERR** Softkey, the **HRZN HDG**, **APTSIGNS**, and **PATHWAY** softkeys may be activated in any combination to display desired features. When system power is cycled, the last selected state (on or off) of the **SYN TERR**, **HRZN HDG**, **APTSIGNS**, and **PATHWAY** softkeys is remembered by the system.

Activating and deactivating SVS:

- 1) Press the **PFD** Softkey.
- 2) Press the **SYN VIS** Softkey.
- 3) Press the **SYN TERR** Softkey. The SVS display will cycle on or off with the **SYN TERR** Softkey.

Activating and deactivating Pathways:

- 1) Press the **PFD** Softkey.
- 2) Press the **SYN VIS** Softkey.
- 3) Press the **PATHWAY** Softkey. The Pathway feature will cycle on or off with the **PATHWAY** Softkey.

Activating and deactivating Horizon Headings:

- 1) Press the **PFD** Softkey.
- 2) Press the **SYN VIS** Softkey.
- 3) Press the **HRZN HDG** Softkey. The horizon heading display will cycle on or off with the **HRZN HDG** Softkey.

Activating and deactivating Airport Signs:

- 1) Press the **PFD** Softkey.
- 2) Press the **SYN VIS** Softkey.
- 3) Press the **APTSIGNS** Softkey. Display of airport signs will cycle on or off with the **APTSIGNS** Softkey.

SVS Features



Figure 11-2 SVS on the Primary Flight Display



NOTE: Pathways and terrain features are not a substitute for standard course and altitude deviation information provided by the CDI, VSI, and VDI.

Pathways

Pathways provide a three-dimensional perspective view of the selected route of flight shown as colored rectangular boxes representing the horizontal and vertical flight path of the active flight plan. The box size represents 700 feet wide by 200 feet tall during enroute, oceanic, and terminal flight phases. During an approach, the box width is 700 feet or one half full scale deviation on the HSI, whichever is less. The height is 200 feet or one half full scale deviation on the VDI, whichever is less. The altitude at

which the pathway boxes are displayed is determined by the selected altitude during climb, cruise, and when the active leg is the final approach course prior to intercepting the glidepath/glideslope. During a descent (except while on the approach glidepath/glideslope), the pathway boxes are displayed at the selected altitude, or the VNAV altitude programmed for the active leg in the flight plan, or the published altitude constraint, whichever is higher (Figure 11-3). Just prior to intercepting the glidepath/glideslope, the pathway boxes are displayed on the glidepath/glideslope, or the selected altitude, whichever is lower.

The color of the rectangular boxes may be magenta, green, or white depending on the route of flight and navigation source selected. The active GPS or GPS overlay flight plan leg is represented by magenta boxes that correspond to the Magenta CDI. A localizer course is represented by green boxes that correspond to a green CDI. An inactive leg of an active flight plan is represented by white boxes corresponding to a white line drawn on the Inset map or MFD map indicating an inactive leg.

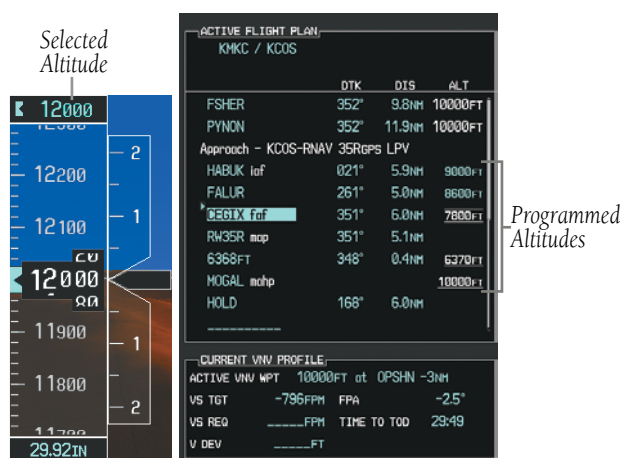

Figure 11-3 Programmed and Selected Altitude

Pathways provide supplemental glidepath information on an active ILS, LPV, LNAV/VNAV, and some LNAV approaches. Pathways are intended as an aid to situational awareness and should not be used independent of the CDI, VDI, glide path indicator, and glide slope indicator. They are removed from the display when the selected navigation information is not available. Pathways are not displayed beyond the active leg when leg sequencing is suspended and are not displayed on any portion of the flight plan leg that would lead to intercepting a leg in the wrong direction.

Departure and Enroute

Prior to intercepting an active flight plan leg, pathways are displayed as a series of boxes with pointers at each corner that point in the direction of the active waypoint. Pathways are not displayed for the first leg of the flight plan if that segment is a Heading-to-Altitude leg. The first segment displaying pathways is the first active GPS leg or active leg with a GPS overlay. If this leg of the flight plan route is outside the SVS field of view, pathways will not be visible until the aircraft has turned toward this leg. While approaching the center of the active leg and prescribed altitude, the number of pathway boxes decreases to a minimum of four.

Pathways are displayed along the flight plan route at the highest of either the selected altitude or the programmed altitude for the leg. Climb profiles cannot be displayed due to the variables associated with aircraft performance. Flight plan legs requiring a climb are indicated by pathways displayed at a level above the aircraft at the altitude selected or programmed.

Descent and Approach

Pathways are shown descending only for a programmed descent (Figures 11-4 and 11-5). When the flight plan includes programmed descent segments, pathways are displayed along the descent path provided that the selected altitude is lower than the programmed altitude.

During a Vectors-to-Final (VTF) approach transition, pathways are displayed along the final approach course inbound to the Missed Approach Point (MAP). Pathways are shown level at the selected altitude or at the next programmed crossing altitude, whichever is higher, up to the point along the final approach course where the altitude intercepts the extended vertical descent path, glidepath, or glideslope.

From the vertical path descent, glidepath, or glideslope intercept point, the pathways are shown inbound to the Missed Approach Point (MAP) along the published lateral and vertical descent path.

During an ILS approach, the initial approach segment is displayed in magenta at the segment altitudes if GPS is selected as the navigation source on the CDI. When switching to localizer inbound with LOC selected as the navigation source on the CDI, pathways are displayed in green along the localizer and glide slope.

VOR, LOC BC, and ADF approach segments that are approved to be flown using GPS are displayed in magenta boxes. Segments that are flown using other than GPS or ILS, such as heading legs or VOR final approach courses are not displayed.

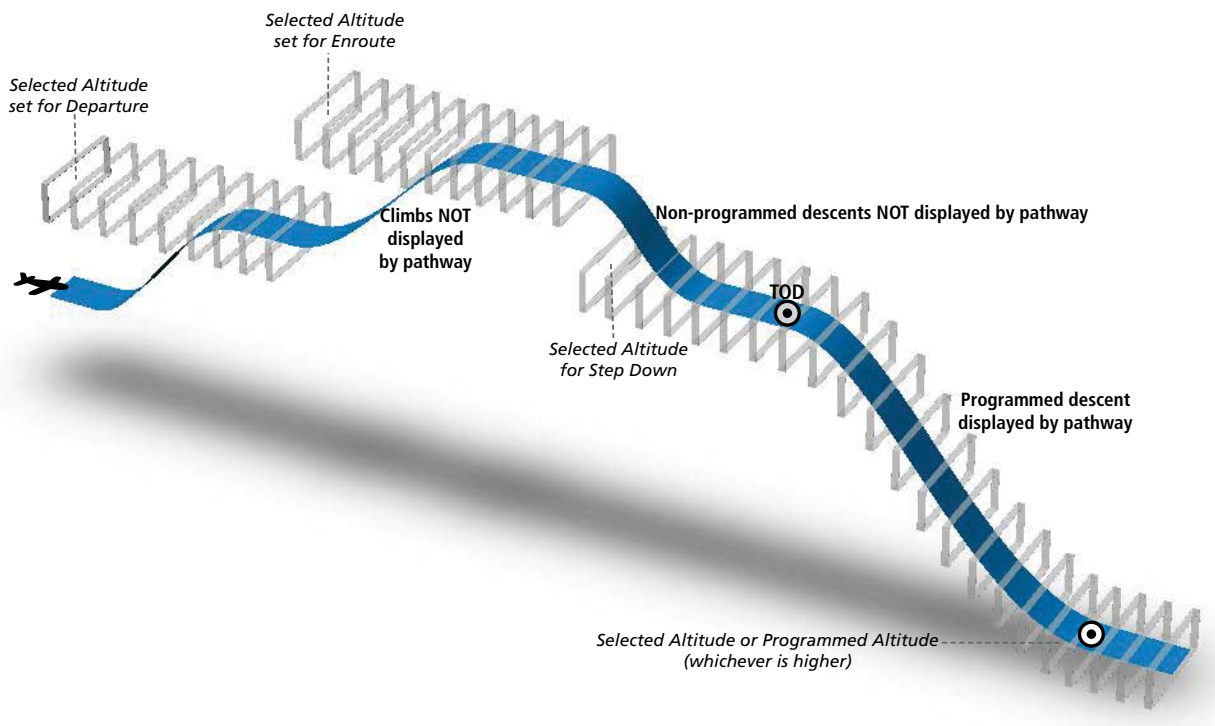

Figure 11-4 SVS Pathways, Enroute and Descent

Missed Approach

Upon activating the missed approach, pathways lead to the Missed Approach Holding Point (MAHP) and are displayed as a level path at the published altitude for the MAHP, or the selected altitude, whichever is the highest. If the initial missed approach leg is a Course-to-Altitude (CA) leg, the pathways boxes will be displayed level at the altitude published for the MAHP. If the initial missed approach leg is defined by a course using other than GPS, pathways are not displayed for that segment.

Pathways are displayed along each segment including the path required to track course reversals that are part of a procedure, such as holding patterns. Pathways boxes will not indicate a turn to a MAHP unless a defined geographical waypoint exists between the MAP and MAHP.

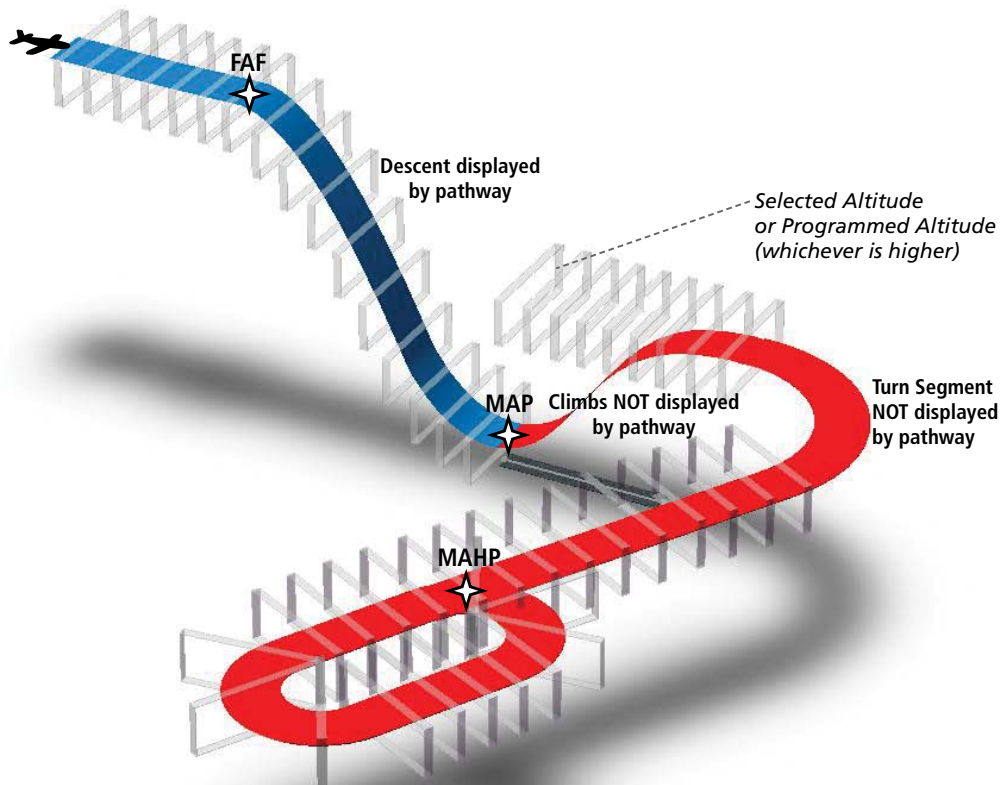

Figure 11-5 SVS Pathways, Approach, Missed Approach, and Holding

Flight Path Marker

The Flight Path Marker (FPM), also known as a Velocity Vector, is displayed on the PFD at groundspeeds above 30 knots. The FPM depicts the approximate projected path of the aircraft accounting for wind speed and direction relative to the three-dimensional terrain display.

The FPM is always available when the Synthetic Terrain feature is in operation. The FPM represents the direction of the flight path as it relates to the terrain and obstacles on the display, while the airplane symbol represents the aircraft heading.

The FPM works in conjunction with the Pathways feature to assist the pilot in maintaining desired altitudes and direction when navigating a flight plan. When on course and altitude the FPM is aligned inside the pathway boxes as shown (Figure 11-6).



Figure 11-6 Flight Path Marker and Pathways

Zero Pitch Line

The Zero Pitch Line is drawn completely across the display and represents the aircraft attitude with respect to the horizon. It may not align with the terrain horizon, particularly when the terrain is mountainous or when the aircraft is flown at high altitudes.

Horizon Heading

The Horizon Heading is synchronized with the HSI and shows approximately 60 degrees of compass heading in 30-degree increments on the Zero Pitch Line. Horizon Heading tick marks and digits appearing on the zero pitch line are not visible behind either the airspeed or altitude display. Horizon Heading is used for general heading awareness, and is activated and deactivated by pressing the **HRZN HDG** Softkey.

Traffic



WARNING: Intruder aircraft at or below 500 ft. AGL may not appear on the SVS display or may appear as a partial symbol.

Traffic symbols are displayed in their approximate locations as determined by the related traffic systems. Traffic symbols are displayed in three dimensions, appearing larger as they are getting closer, and smaller when they are further away. Traffic within 250 feet laterally of the aircraft will not be displayed on the SVS display. Traffic symbols and coloring are consistent with that used for traffic displayed in the Inset map or MFD traffic page. If the traffic altitude is unknown, the traffic will not be displayed on the SVS display. For more details refer to the traffic system discussion in the Hazard Avoidance section.

Airport Signs

Airport Signs provide a visual representation of airport location and identification on the synthetic terrain display. When activated, the signs appear on the display when the aircraft is approximately 15 nm from an airport and disappear at approximately 4.5 nm. Airport signs are shown without the identifier until the aircraft is approximately eight nautical miles from the airport. Airport signs are not shown behind the airspeed or altitude display. Airport signs are activated and deactivated by pressing the **APTSIGNS** Softkey.

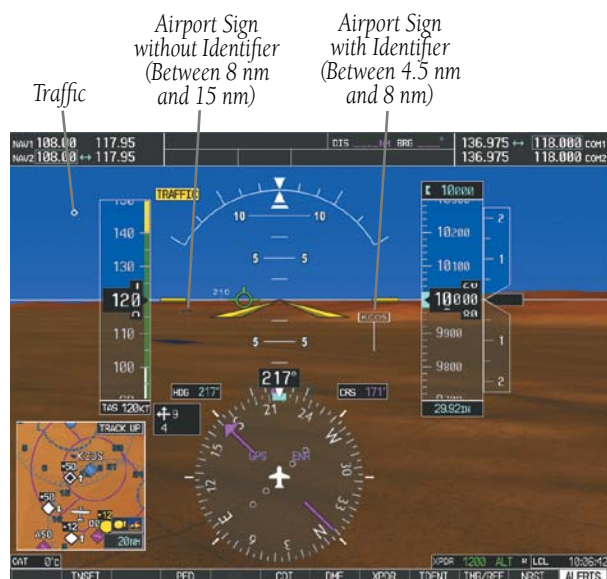

Figure 11-7 Airport Signs

Runways



WARNING: Do not use SVS runway depiction as the sole means for determining the proximity of the aircraft to the runway or for maintaining the proper approach path angle during landing.



NOTE: Not all airports have runways with endpoint data in the database, therefore, these runways are not displayed.

Runway data provides improved awareness of runway location with respect to the surrounding terrain. All runway thresholds are depicted at their respective elevations as defined in the database. In some situations, where threshold elevations differ significantly, crossing runways may appear to be layered. As runways are displayed, those within 45 degrees of the aircraft heading are displayed in white. Other runways will be gray in color. When an approach for a specific runway is active, that runway will appear brighter and be outlined with a white box, regardless of the runway orientation as related to aircraft heading. As the aircraft gets closer to the runway, more detail such as runway numbers and centerlines will be displayed.

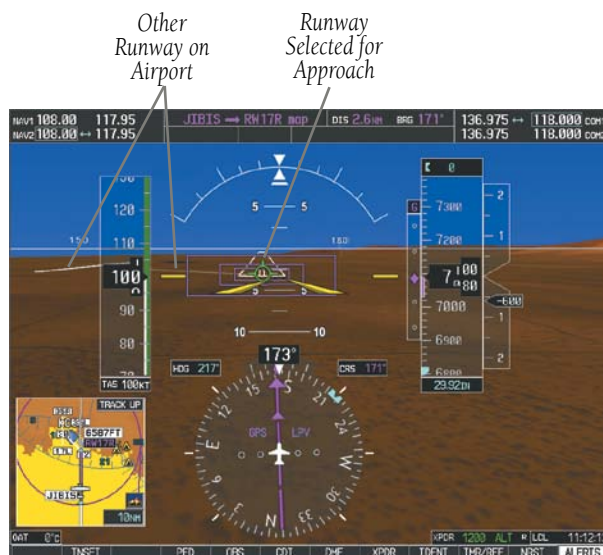

Figure 11-8 Airport Runways

Terrain-SVS and TAWS Alerting

Terrain alerting on the synthetic terrain display is triggered by Forward-looking Terrain Avoidance (FLTA) alerts, and corresponds to the red and yellow X symbols on the Inset Map and MFD map displays. For more detailed information regarding Terrain-SVS and TAWS, refer to the Hazard Avoidance Section.

In some instances, a terrain or obstacle alert may be issued with no conflict shading displayed on the synthetic terrain. In these cases, the conflict is outside the SVS field of view to the left or right of the aircraft.

Obstacles are represented on the synthetic terrain display by standard two-dimensional tower symbols found on the Inset map and MFD maps and charts. Obstacle symbols appear in the perspective view with relative height above terrain and distance from the aircraft. Unlike the Inset map and MFD moving map display, obstacles on the synthetic terrain display do not change colors to warn of potential conflict with the aircraft's flight path until the obstacle is associated with an actual FLTA alert. Obstacles greater than 1000 feet below the aircraft altitude are not shown. Obstacles are shown behind the airspeed and altitude displays.

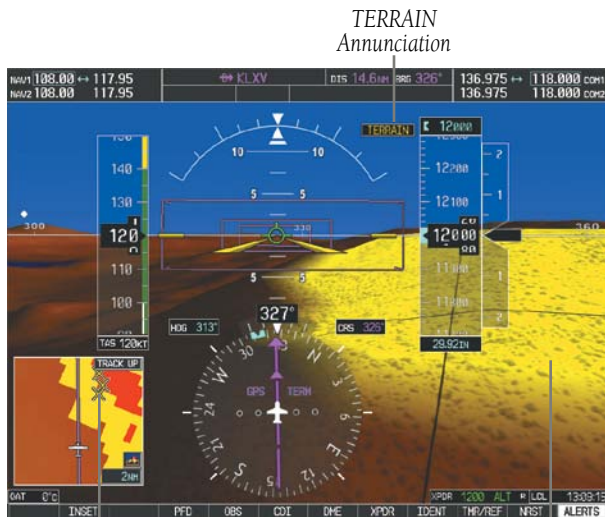

Potential Impact Points

Terrain Caution

Figure 11-9 Terrain Alert



Potential Impact Point

Obstacle Caution

Figure 11-10 Obstacle

Field of View

Two dashed lines forming a V-shape in front of the aircraft symbol on the MFD map, represent the forward viewing area shown on the PFD.



SVS View on the PFD



Field of View on the MFD

Figure 11-11 PFD and MFD Field of View Comparison

Configuring field of view:

- 1) While viewing the Navigation Map Page, press the **MENU** Key to display the PAGE MENU.

- 2) Turn the large **FMS** Knob to highlight Map Setup and press the **ENT** Key.
- 3) Turn the **FMS** Knob to select the Map Group and press the **ENT** Key.

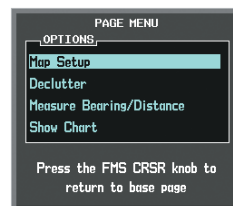

Navigation Map Page OPTIONS Menu



Map Setup Menu, Map Group, Field of View Option

Figure 11-12 Enabling SVS Field of View

- 4) Turn the large **FMS** Knob to scroll to FIELD OF VIEW.
- 5) Turn the small **FMS** Knob to select On or Off.
- 6) Press the **FMS** Knob to return to the Navigation Map Page.

11.2 SAFETAXI

When viewing at ranges close enough to show the airport detail, the map reveals taxiways with identifying letters/numbers, airport Hot Spots, and airport landmarks including ramps, buildings, control towers, and other prominent features. Resolution is greater at lower map ranges.

Airport Hot Spots are outlined to caution pilots of areas on an airport surface where positional awareness confusion or runway incursions happen most often. Hot Spots are defined with a magenta circle or outline around the region of possible confusion.

Any map page that displays the navigation view can also show the SafeTaxi airport layout within the maximum configured range.

During ground operations the aircraft's position is displayed in reference to taxiways, runways, and airport features. When panning over the airport, features such as runway holding lines and taxiways are shown at the cursor.



Figure 11-13 SafeTaxi Depiction on the Navigation Map Page

Configuring SafeTaxi range:

- 1) While viewing the Navigation Map Page, press the **MENU** Key to display the PAGE MENU.
- 2) Turn the large **FMS** Knob to highlight the Map Setup Menu Option and press the **ENT** Key.

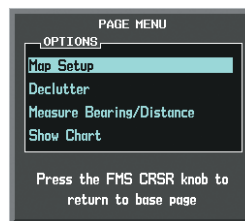

Figure 11-14 Navigation Map PAGE MENU

- 3) Turn the **FMS** Knob to select the Aviation Group and press the **ENT** Key.
- 4) Turn the large **FMS** Knob to scroll through the Aviation Group options to SAFETAXI.
- 5) Turn the small **FMS** Knob to display the range of distances.
- 6) Turn either **FMS** Knob to select the desired distance for maximum SafeTaxi display range.
- 7) Press the **ENT** Key to complete the selection.
- 8) Press the **FMS** Knob to return to the Navigation Map Page.

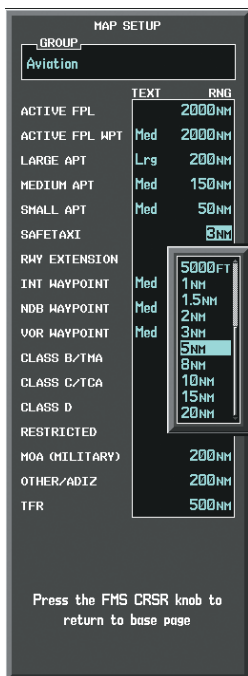

Figure 11-15 MAP SETUP Menu, Aviation Group

11.3 CHARTVIEW (OPTIONAL)

The optional ChartView feature resembles the paper version of Jeppesen terminal procedures charts. The MFD depiction shows the aircraft position on the moving map in the plan view of approach charts and on airport diagrams. Airport Hot Spots are outlined in magenta.

ChartView functions are displayed on three levels of softkeys. While on the Navigation Map Page, Nearest Airports Page, or Flight Plan Page, pressing the **SHW CHRT** Softkey displays the available terminal chart and advances to the chart selection level of softkeys: **CHRT OPT**, **CHRT**, **INFO**, **DP**, **STAR**, **APR**, **WX**, **NOTAM**, and **GO BACK**. The chart selection softkeys shown in Figure 11-16 appear on the Airport Information Page.

Pressing the **GO BACK** Softkey reverts to the top level softkeys and previous page.

Pressing the **CHRT OPT** Softkey advances to the next level of softkeys: **ALL**, **HEADER**, **PLAN**, **PROFILE**, **MINIMUMS**, **FIT WDTN**, **FULL SCN**, and **BACK**.

While viewing the **CHRT OPT** Softkeys, after 45 seconds of softkey inactivity, the system reverts to the chart selection softkeys.

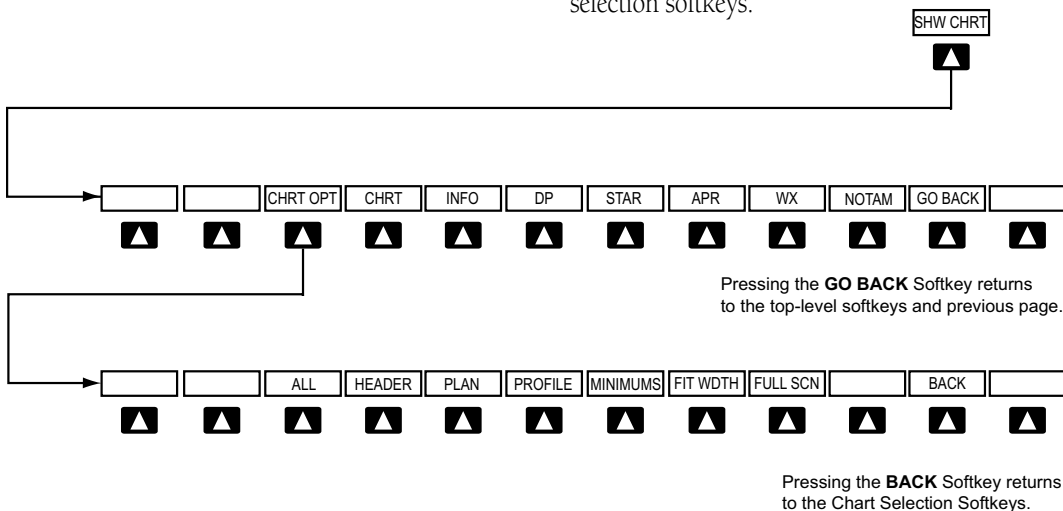

Figure 11-16 ChartView Softkeys

SECTION 11 – ADDITIONAL FEATURES

If a chart is available for the destination airport, or the airport selected in the active flight plan, the chart appears on the screen. When no flight plan is active, or when not flying to a direct-to destination, pressing the **SHW CHRT** Softkey displays the chart for the nearest airport, if available.

When no terminal procedure chart is available for the nearest airport or the selected airport, the banner **CHART NOT AVAILABLE** appears on the screen. The **CHART NOT AVAILABLE** banner does not refer to the Jeppesen subscription, but rather the availability of a particular airport chart selection or procedure for a selected airport.

If there is a problem in rendering the data (such as a data error or a failure of an individual chart), the banner **UNABLE TO DISPLAY CHART** is then displayed.

Chart Options

Pressing the **CHRT OPT** Softkey displays the next level of softkeys, the chart options level.

Pressing the **FULL SCN** Softkey displays the chart using the full width of the screen.

Pressing the **ALL** Softkey shows the full approach chart on the screen.

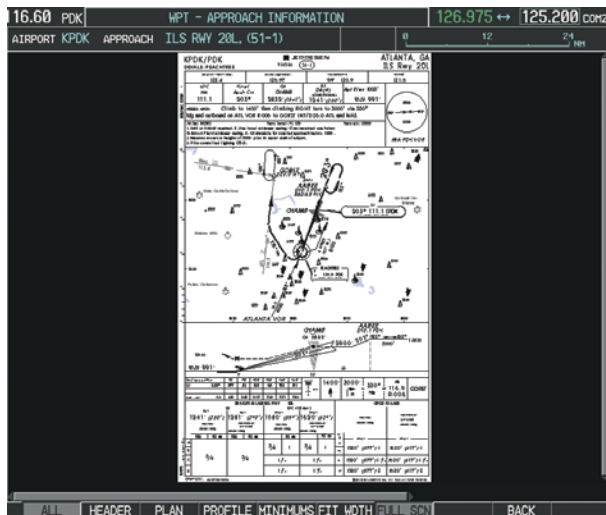

Figure 11-17 Approach Information Page, ALL View

Pressing the **HEADER** Softkey shows the header view (approach chart briefing strip) on the screen.

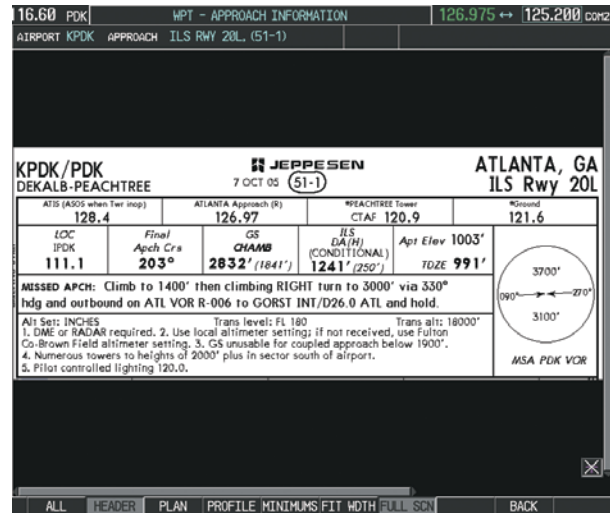

Figure 11-18 Approach Information Page, Header View

Pressing the **PLAN** Softkey shows the approach chart two dimensional plan view.

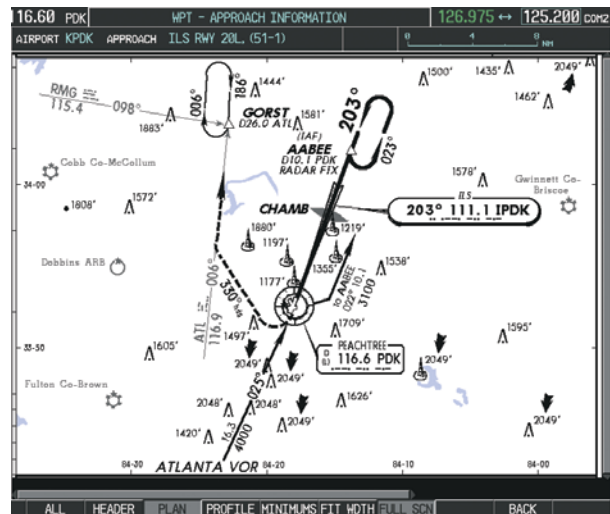

Figure 11-19 Approach Information Page, Plan View

Pressing the **PROFILE** Softkey displays the approach chart descent profile strip.

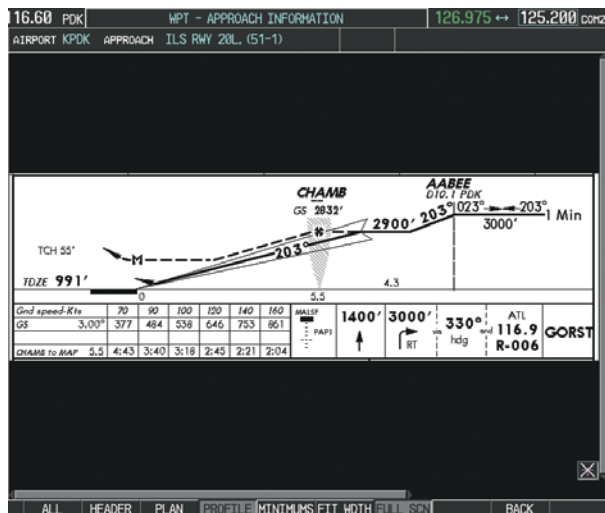

Figure 11-20 Approach Information Page, Profile View

Pressing the **MINIMUMS** Softkey displays the minimum descent altitude/visibility strip at the bottom of the approach chart.

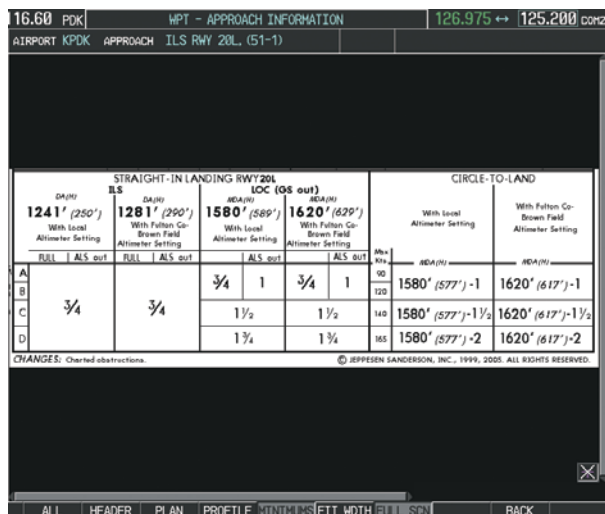

Figure 11-21 Approach Information Page, Minimums View

If the chart scale has been adjusted to view a small area of the chart, pressing the **FIT WIDTH** Softkey changes the chart size to fit the available screen width.

Day/Night View

ChartView can be displayed on a white or black background for day or night viewing. The Day View offers a better presentation in a bright environment.

Selecting Day, Night, or Automatic View:

- 1) While viewing a terminal chart press the **MENU** Key to display the Page Menu **OPTIONS**.
- 2) Turn the large **FMS** Knob to highlight the Chart Setup Menu Option and press the **ENT** Key.
- 3) Turn the large **FMS** Knob to move to the **COLOR SCHEME** Option.

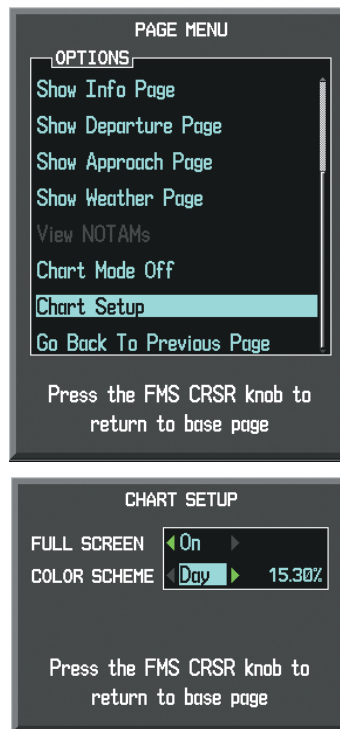

Figure 11-22 Selecting Day, Night, or Automatic View

- 4) Turn the small **FMS** Knob to choose between Day, Auto, and Night Options.
- 5) If Auto Mode is selected, turn the large **FMS** Knob to select the percentage field. Use the small **FMS** Knob to change the percentage value. The percentage value is the day/night crossover point based on the percentage of backlighting intensity. For example, if the value is set to 15%, the day/night display changes when the display backlight reaches 15% of full brightness.

The display must be changed in order for the new setting to become active. This may be accomplished by selecting another page or changing the display range.
- 6) Press the **FMS** Knob when finished to remove the Chart Setup Menu.

11.4 FLITECHARTS

The optional FliteCharts feature resembles the paper version of AeroNav Services terminal procedures charts. The charts are displayed with high-resolution and in color for applicable charts. FliteCharts database subscription is available from Garmin.

FliteCharts functions are displayed on three levels of softkeys. While on the Navigation Map Page, Nearest Airports Page, or Flight Plan Page, pressing the **SHW CHRT** Softkey displays the available terminal chart and advances to the chart selection level of softkeys: **CHRT OPT**, **CHRT**, **INFO**, **DP**, **STAR**, **APR**, **WX**, and **GO BACK**. The chart selection softkeys appear on the Airport Information Page.

Pressing the **GO BACK** Softkey reverts to the top level softkeys and previous page.

Pressing the **CHRT OPT** Softkey displays the available terminal chart and advances to the next level of softkeys: **ALL**, **FIT WDTN**, **FULL SCN**, and **BACK**.

While viewing the **CHRT OPT** Softkeys, after 45 seconds of softkey inactivity, the system reverts to the chart selection softkeys.

If a chart is available for the destination airport, or the airport selected in the active flight plan, the chart appears on the screen. When no flight plan is active, or when not flying to a direct-to destination, pressing the **SHW CHRT** Softkey displays the chart for the nearest airport, if available.

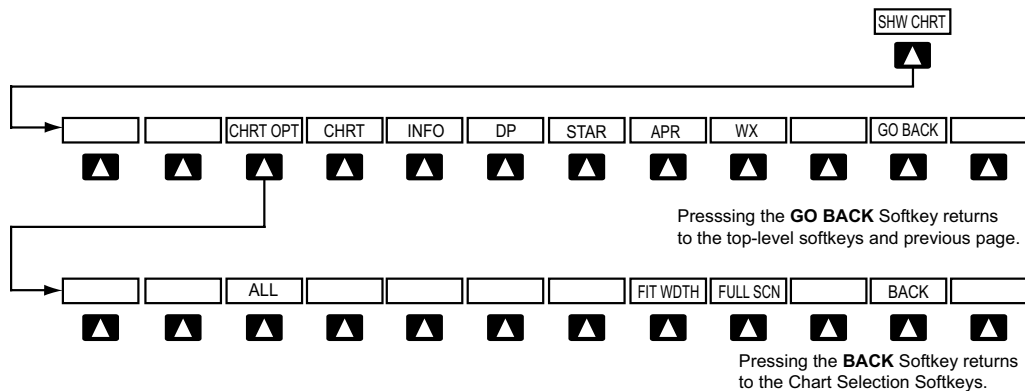

Figure 11-23 FliteCharts Softkeys

NOTAMs are not available with FliteCharts. The NOTAM Softkey label appears subdued and is disabled.

When no terminal procedure chart is available, the banner CHART NOT AVAILABLE appears on the screen. The CHART NOT AVAILABLE banner does not refer to the FliteCharts subscription, but rather the availability of a particular airport chart selection or procedure for a selected airport.

If there is a problem in rendering the data (such as a data error or a failure of an individual chart), the banner UNABLE TO DISPLAY CHART is then displayed.

Chart Options

Pressing the **CHRT OPT** Softkey displays the next level of softkeys, the chart options level (Figure 11-24).

Pressing the **ALL** Softkey shows the entire chart on the screen.



Figure 11-24 Airport Information Page, ALL View Selected

Pressing the **FIT WIDTH** Softkey fits the width of the chart in the display viewing area.

Pressing the **FULL SCN** Softkey alternates between removing and replacing the data window to the right.

Day/Night View

FliteCharts can be displayed on a white or black background for day or night viewing. The Day View offers a better presentation in a bright environment.

Selecting Day, Night, or Automatic View:

- 1) While viewing a terminal chart press the **MENU** Key to display the Page Menu **OPTIONS** (see Figure 11-22).
- 2) Turn the large **FMS** Knob to highlight the Chart Setup Menu Option and press the **ENT** Key.
- 3) Turn the large **FMS** Knob to move to the **COLOR SCHEME** Option (see Figure 11-22).
- 4) Turn the small **FMS** Knob to choose between Day, Auto, and Night Options.
- 5) If Auto Mode is selected, turn the large **FMS** Knob to select the percentage field. Use the small **FMS** Knob to change the percentage value. The percentage value is the day/night crossover point based on the percentage of backlighting intensity. For example, if the value is set to 15%, the day/night display changes when the display backlight reaches 15% of full brightness.

The display must be changed in order for the new setting to become active. This may be accomplished by selecting another page or changing the display range.
- 6) Press the **FMS** Knob when finished to remove the Chart Setup Menu.

11.5 AOPA AIRPORT DIRECTORY

The Aircraft Owners and Pilots Association (AOPA) Airport Directory database offers detailed information regarding services, hours of operation, lodging options, and more. This information is viewed on the Airport Directory Page by selecting the **INFO** Softkey until **INFO-2** is displayed.

11.6 XM RADIO ENTERTAINMENT (SERVICE OPTIONAL)



NOTE: Refer to the Hazard Avoidance Section for information about XM Weather products.

The optional XM Radio entertainment feature is available for the pilot's and passengers' enjoyment throughout the Continental U.S.

Using XM Radio

The XM Radio Page provides information and control of the audio entertainment features of the XM Satellite Radio.

Selecting the XM Radio Page:

- 1) Turn the large **FMS** Knob to select the 'AUX' page group.
- 2) Turn the small **FMS** Knob to select the displayed AUX - XM Information Page.
- 3) Press the **RADIO** Softkey to show the XM Radio Page where audio entertainment is controlled.



Figure 11-25 XM Radio Page

Active Channel and Channel List

The Active Channel Box on the XM Radio Page displays the currently selected channel that the XM Radio is using.

The Channels List Box of the XM Radio Page shows a list of the available channels for the selected category. Channels can be stepped through one at a time or may be selected directly by channel number.

Selecting a channel from the channel list:

- 1) While on the XM Radio Page, press the **CHNL** Softkey.
- 2) Press the **CH +** Softkey to go up through the list in the Channel Box, or move down the list with the **CH -** Softkey.

Or:

- 1) Press the **FMS** Knob to highlight the channel list and turn the large **FMS** Knob to scroll through the channels.
- 2) Press the **ENT** Key to activate the selected channel.

Selecting a channel directly:

- 1) While on the XM Radio Page, press the **CHNL** Softkey.
- 2) Press the **DIR CH** Softkey. The channel number in the Active Channel Box is highlighted.
- 3) Press the numbered softkeys located on the bottom of the display to directly select the desired channel number.
- 4) Press the **ENT** Key to activate the selected channel.

Category

The Category Box of the XM Radio Page displays the currently selected category of audio. Categories of channels such as jazz, rock, or news can be selected to list the available channels for a type of music or other contents. One of the optional categories is PRESETS to view channels that have been programmed.

Selecting a category:

- 1) Press the **CATGRY** Softkey on the XM Radio Page.
- 2) Press the **CAT +** and **CAT -** Softkeys to cycle through the categories.

Or:

Turn the small **FMS** Knob to display the Categories list (Figure 11-26). Highlight the desired category with the small **FMS** Knob and press the **ENT** Key. Selecting All Categories places all channels in the list.



Figure 11-26 Categories List

Presets

Up to 15 channels from any category can be assigned a preset number. The preset channels are selected by pressing the **PRESETS** and **MORE** Softkeys. Then the preset channel can be selected directly and added to the channel list for the Presets category.

Setting a preset channel number:

- 1) On the XM Radio Page, while listening to an Active Channel that is wanted for a preset, press the **PRESETS** Softkey to access the first five preset channels (**PS1 - PS5**) (Figure 11-27).
- 2) Press the **MORE** Softkey to access the next five channels (**PS6 - PS10**), and again to access the last five channels (**PS11 - PS15**). Pressing the **MORE** Softkey repeatedly cycles through the preset channels.
- 3) Press any one of the (**PS1 - PS15**) softkeys to assign a number to the active channel.
- 4) Press the **SET** Softkey on the desired channel number to save the channel as a preset.

Pressing the **BACK** Softkey, or waiting during 45 seconds of softkey inactivity, returns the system to the top level softkeys.



Figure 11-27 Accessing and Selecting XM Preset Channels

Volume

Radio volume is shown as a percentage. Volume level is controlled by pressing the **VOL** Softkey, which brings up the **MUTE** Softkey and the volume increase and decrease softkeys.

Adjusting the volume:

- 1) With the XM Radio Page displayed, press the **VOL** Softkey.
- 2) Press the **VOL –** Softkey to reduce volume or press the **VOL +** Softkey to increase volume. (Once the **VOL** Softkey is pressed, the volume can also be adjusted using the small **FMS** Knob.)
- 3) Press the **MUTE** Softkey to mute the audio. Press the **MUTE** Softkey again to unmute the audio.

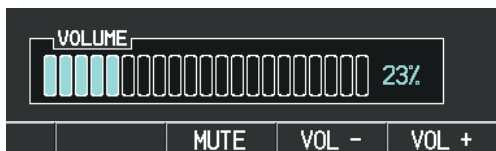

Figure 11-28 Volume Control

Automatic Audio Muting

XM Radio audio is muted automatically when the aircraft groundspeed exceeds approximately 30 knots and the airspeed is less than approximately 80 knots. The audio is not unmuted automatically. The audio must be manually unmuted once the aircraft is airborne and outside the applicable speed range. Automatic Audio Muting has been implemented to meet regulatory requirements that the aural stall warning be heard.

When the aircraft is operating within the automute airspeed range, the **MUTE** Softkey and the volume softkeys are subdued, and the Unmute selection of the Page Menu is unavailable, preventing the audio from being unmuted at this time.

Audio availability conforms to the following three states:

- Audio is available on the ground until the aircraft exceeds 30 knots
- Audio is automatically muted (not available) from Airborne Status up to 80 knots airspeed
- Audio is available when airspeed is over 80 knots

Unmuting XM audio:

- 1) With the XM Radio Page displayed, press the **VOL** Softkey.
- 2) Press the **MUTE** Softkey to restore (unmute) XM Audio.

11.7 SCHEDULER

The Scheduler feature can be used to enter and display reminder messages (e.g., Change oil, Switch fuel tanks, or Altimeter-Transponder Check) in the Alerts Window on the PFD. Messages can be set to display based on a specific date and time (event), once the message timer reaches zero (one-time; default setting), or recurrently whenever the message timer reaches zero (periodic). Message timers set to periodic alerting automatically reset to the original timer value once the message is displayed. When power is cycled, all messages are retained until deleted, and message timer countdown is resumed.

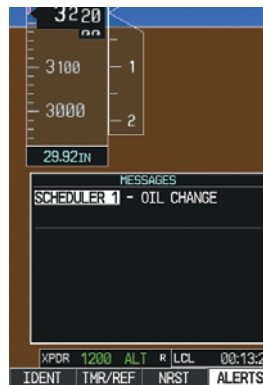

Figure 11-29 PFD Alerts Window



Figure 11-30 Scheduler (Utility Page)

Entering a scheduler message:

- 1) Select the AUX - Utility Page.
- 2) Press the **FMS** Knob momentarily to activate the flashing cursor.
- 3) Turn the large **FMS** Knob to highlight the first empty scheduler message naming field.
- 4) Use the **FMS** Knob to enter the message text to be displayed in the Alerts Window and press the **ENT** Key.
- 5) Press the **ENT** Key again or use the large **FMS** Knob to move the cursor to the field next to Type.
- 6) Turn the small **FMS** Knob to select the message alert type:
 - Event—Message issued at the specified date/time
 - One-time—Message issued when the message timer reaches zero (default setting)
 - Periodic—Message issued each time the message timer reaches zero

- 7) Press the **ENT** Key again or use the large **FMS** Knob to move the cursor to the next field.
- 8) For periodic and one-time message, use the **FMS** Knob to enter the timer value (HH:MM:SS) from which to countdown and press the **ENT** Key.
- 9) For event-based messages:
 - a) Use the **FMS** Knob to enter the desired date (DD-MM-YY) and press the **ENT** Key.
 - b) Press the **ENT** Key again or use the large **FMS** Knob to move the cursor to the next field.
 - c) Use the **FMS** Knob to enter the desired time (HH:MM) and press the **ENT** Key.
- 10) Press the **ENT** Key again or use the large **FMS** Knob to move the cursor to enter the next message.

Deleting a scheduler message:

- 1) Select the AUX - Utility Page.
- 2) Press the **FMS** Knob momentarily to activate the flashing cursor.
- 3) Turn the large **FMS** Knob to highlight the name field of the scheduler message to be deleted.
- 4) Press the **CLR** Key to clear the message text. If the **CLR** Key is pressed again, the message is restored.
- 5) Press the **ENT** Key while the message line is cleared to clear the message time.

11.8 ELECTRONIC CHECKLISTS



NOTE: The checklists presented here are for example only and may not reflect checklists actually available for the Cessna NAV III Aircraft. This material is not intended to replace the checklist information presented in the AFM or the Pilot Safety and Warning Supplements document.



NOTE: Garmin is not responsible for the content of checklists. Cessna NAV III Aircraft checklists are created, modified, and updated by the aircraft manufacturer.

The optional checklist functions are displayed on two levels of softkeys that are available on any MFD page.

The MFD is able to display optional electronic checklists which allow a pilot to quickly find the proper procedure on the ground and during each phase of flight. The G1000 accesses the checklists from an SD card inserted into the bezel slot. If the SD card contains an invalid checklist file or no checklist, the Power-up Page messages display 'Checklist File: Invalid' or 'Checklist File: N/A' (not available) and the **CHKLIST** Softkey is not available.

Accessing and navigating checklists:

- 1) From any page on the MFD, press the **CHKLIST** Softkey turn the large FMS Knob to select the Checklist Page.
- 2) Turn the large **FMS** Knob to select the 'GROUP' field.
- 3) Turn the small **FMS** Knob to select the desired procedure and press the **ENT** Key.
- 4) Turn the large **FMS** Knob to select the 'CHECKLIST' field.
- 5) Turn the **FMS** Knob to select the desired checklist and press the **ENT** Key. The selected checklist item is indicated with white text surrounded by a white box.
- 6) Press the **ENT** Key or **CHECK** Softkey to check the selected checklist item. The line item turns green and a checkmark is placed in the associated box. The next line item is automatically selected for checking.

Either **FMS** Knob can be used to scroll through the checklist and select the desired checklist item.

Press the **CLR** Key or **UNCHECK** Softkey to remove a check mark from an item.

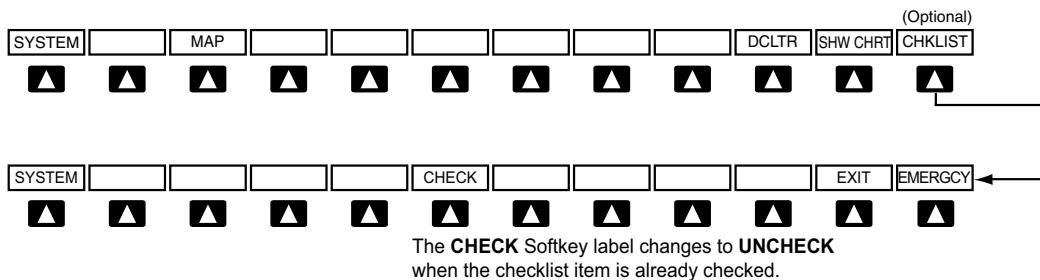

Figure 11-31 Checklist Softkeys

- 7) When all checklist items have been checked, ‘*Checklist Finished*’ is displayed in green text at the bottom left of the checklist window. If all items in the checklist have not be checked, ‘*CHECKLIST NOT FINISHED*’ will be displayed in yellow text.\
- 8) Press the **ENT** Key. ‘GO TO NEXT CHECKLIST?’ will be highlighted by the cursor.
- 9) Press the **ENT** Key to advance to the next checklist.
- 10) Press the **EXIT** Softkey to exit the Checklist Page and return to the page last viewed.

Accessing emergency procedures:

- 1) From any page on the MFD, press the **CHKLIST** Softkey turn the large FMS Knob to select the Checklist Page.
- 2) Press the **EMERGENCY** Softkey.
- 3) Turn the **FMS** Knob to select the desired emergency checklist and press the **ENT** Key.
- 4) Press the **ENT** Key or **CHECK** Softkey to check the selected emergency checklist item. The line item turns green and a checkmark is placed in the box next to it. The next line item is automatically highlighted for checking.

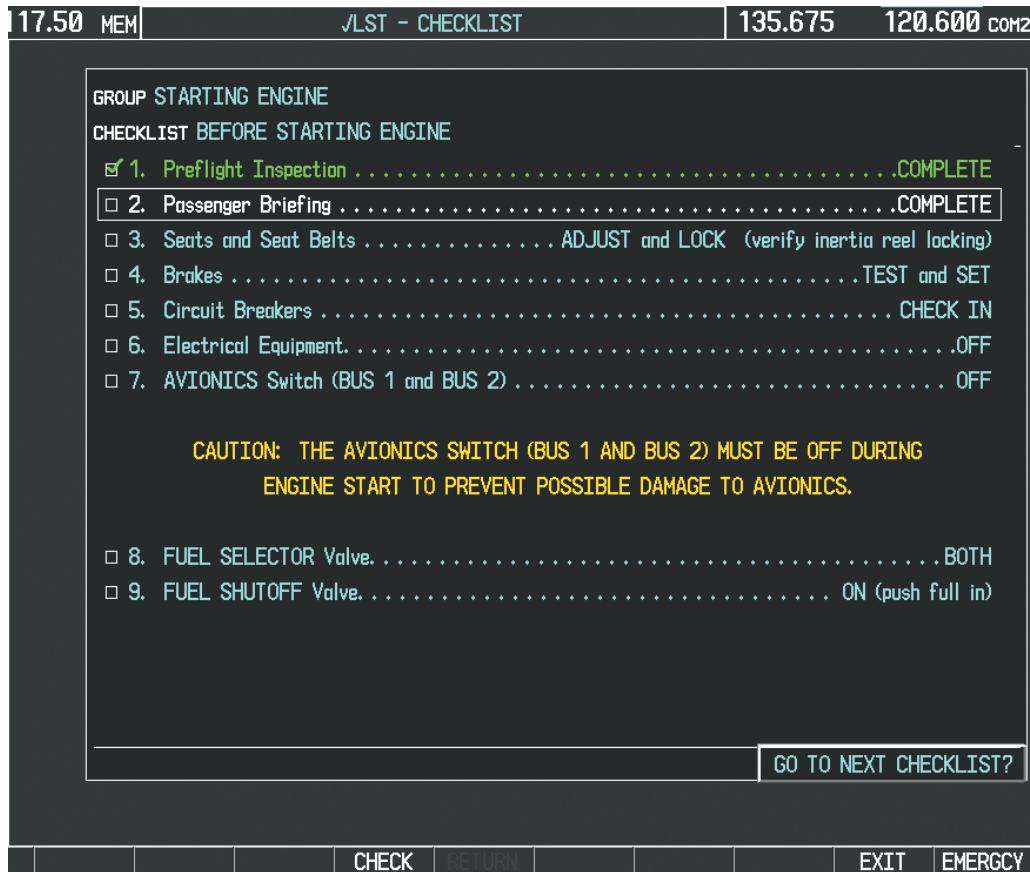

Figure 11-32 Sample Checklist

Either **FMS** Knob can be used to scroll through the checklist and select the desired checklist item.

Press the **CLR** Key or **UNCHECK** Softkey to remove a check mark from an item.

- 5) When all checklist items have been checked, '*Checklist Finished*' is displayed in green text at the bottom left of the checklist window. If all items in the checklist have not be checked, '*CHECKLIST NOT FINISHED*' will be displayed in yellow text.
- 6) Press the **ENT** Key. 'GO TO NEXT CHECKLIST?' will be highlighted by the cursor.

- 7) Press the **ENT** Key to advance to the next checklist.
- 8) Press the **RETURN** Softkey to return to the previous checklist.
- 9) Press the **EXIT** Softkey to exit the Checklist Page and return to the page last viewed.

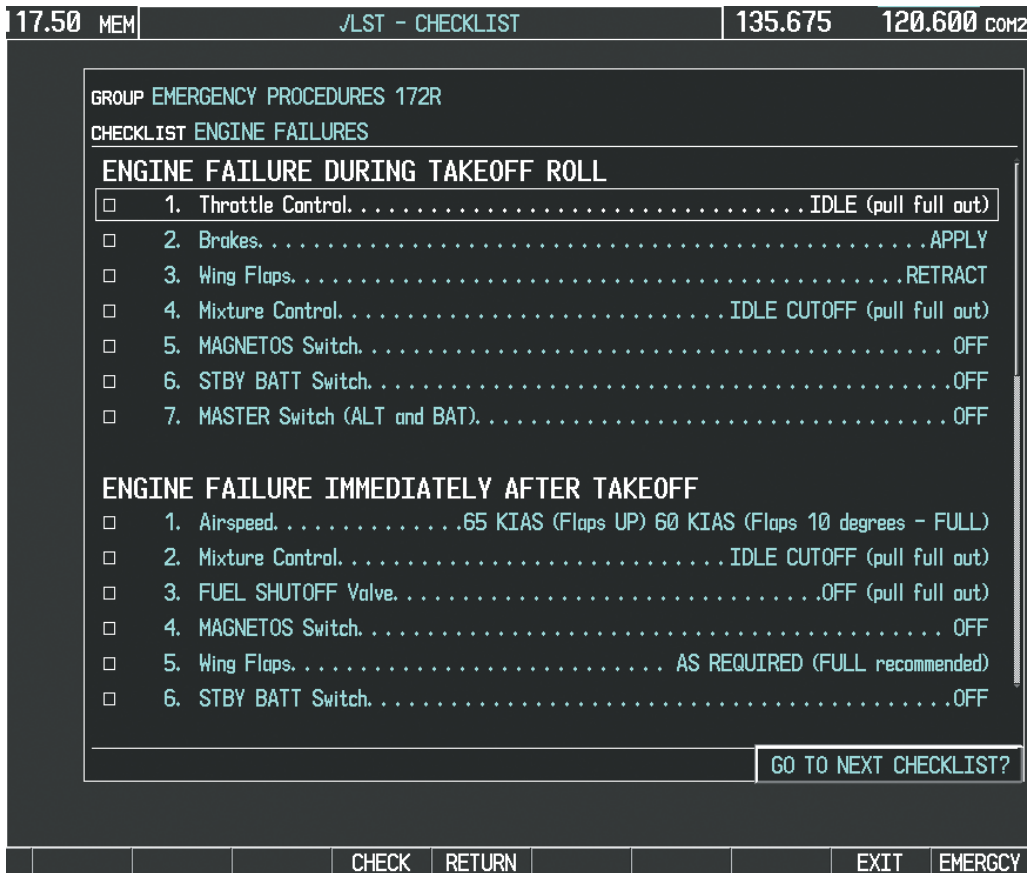

Figure 11-33 Emergency Checklist Page Example

11.9 FLIGHT DATA LOGGING



NOTE: *Some aircraft installations may not provide all aircraft/engine data capable of being logged by the system.*

The Flight Data Logging feature will automatically store critical flight and engine data on an SD data card (up to 8GB) inserted into the top card slot of the MFD. Approximately 1,000 flight hours can be recorded for each 1GB of available space on the card.

Data is written to the SD card once each second while the MFD is powered on. All flight data logged on a specific date is stored in a file named in a format which includes that date (dataYYYY_MM_DD.csv). The file is created automatically each time the G1000 system is powered on, provided an SD card has been inserted.

The status of the Flight Data Logging feature can be viewed on the AUX-UTILITY Page. If no SD card has been inserted, “NO CARD” is displayed. When data is being written to the SD card, “LOGGING DATA” is displayed.

The following is a list of data parameters the G1000 system is capable of logging for the Cessna Nav III aircraft.

- Date
- Time
- GPS altitude (MSL)
- GPS altitude (WGS84 datum)
- Baro-Corrected altitude (feet)
- Baro Correction (in/Hg)
- Indicated airspeed (kts)
- Vertical speed (fpm)
- GPS vertical speed (fpm)
- OAT (degrees C)
- True airspeed (knots)
- Pitch Attitude Angle (degrees)
- Roll Attitude Angle (degrees)
- Lateral and Vertical G Force (g)
- Ground Speed (kts)
- Ground Track (degrees magnetic)
- Latitude (degrees; geodetic; +North)
- Longitude (degrees; geodetic; +East)
- Magnetic Heading (degrees)
- HSI source
- Selected course
- Com1/Com2 frequency
- Nav1/Nav2 frequency
- CDI deflection
- VDI/GP/GS deflection
- Wind Direction (degrees)
- Wind Speed (knots)
- Active Waypoint Identifier
- Distance to next waypoint (nm)
- Bearing to next waypoint (degrees)
- Magnetic variation (degrees)
- Autopilot On/Off
- AFCS roll/pitch modes
- AFCS roll/pitch commands
- GPS fix
- GPS horizontal alert limit
- GPS vertical alert limit
- SBAS GPS horizontal protection level
- SBAS GPS vertical protection level
- Fuel Qty (right & left)(gals)
- Fuel Flow (gph)
- Fuel Pressure (psi)
- Voltage 1 and/or 2
- Amps 1 and/or 2
- Engine RPM
- Oil Pressure (psi)
- Oil Temperature (deg. F)
- TIT (deg. F)
- Manifold Pressure (in. Hg)
- CHT
- EGT

The .csv file may be viewed with Microsoft Excel® or other spreadsheet applications.

The file containing the recorded data will appear in the format shown in Figure 11-33. This file can be imported into most computer spreadsheet applications.

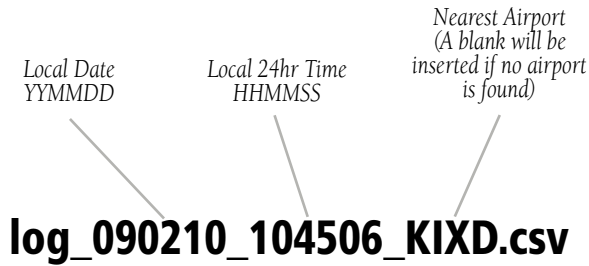

Figure 11-34 Log File Format

Data logging status can be monitored on the AUX-UTILITY Page.

11.10 AUXILIARY VIDEO (OPTIONAL)

There are four modes of operation of the optional auxiliary video display: Full-Screen, Full-Screen with Digital Zoom, Split-Screen with Map, and Split-Screen with Map and Digital Zoom.

Displaying auxiliary video:

- 1) Turn the large **FMS** Knob on the MFD to select the AUX page group.
- 2) Turn the small **FMS** Knob to select VIDEO and display the AUX-VIDEO Page.

Control of the AUX - VIDEO Page can also be accessed through the Page Menu.



Figure 11-35 AUX - VIDEO Page Menu

The video display softkeys shown in the following illustration appear on the AUX - VIDEO Page.

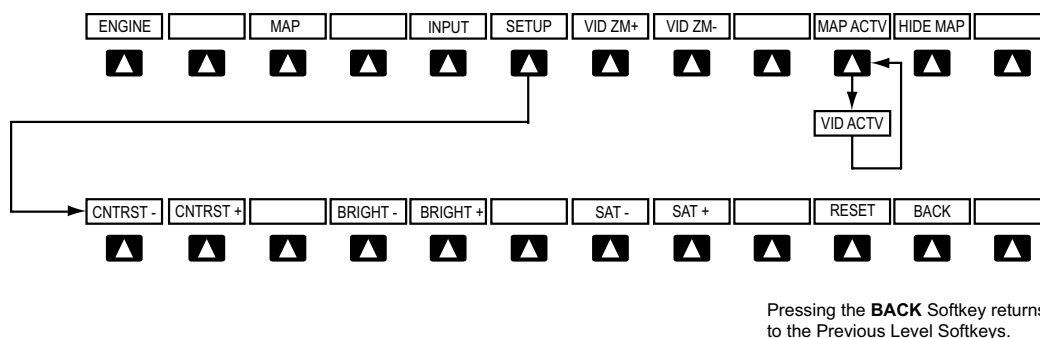

Figure 11-36 Video Display Softkeys

Selecting video menu options:

- 1) While viewing the AUX - VIDEO Page press the **MENU** Key to display the Page Menu OPTIONS.
- 2) Turn the large **FMS** Knob to highlight the desired video adjustment option and press the **ENT** Key.

Once the **ENT** key is pressed on any option, the page menu closes and returns to the AUX - VIDEO Page.

Video Setup

Video brightness, contrast, and saturation may be adjusted by selecting the setup function. While viewing the setup function softkeys, after 45 seconds of softkey inactivity, the system reverts to the AUX - VIDEO Page softkeys.

Adjusting the video settings:

- 1) With the AUX-VIDEO Page displayed, press the **SETUP** Softkey.
- 2) Press the **BRIGHT -** or **BRIGHT +**, to adjust display brightness in five percent increments from 0 to 100%.
- 3) Press the **CNTRST-** or **CNTRST +**, to adjust display contrast in five percent increments from 0 to 100%.

- 4) Press the **SAT -** or **SAT +**, to adjust display saturation five percent increments from 0 to 100%.
- 5) If desired, return the display to the default settings by pressing the **RESET** Softkey.
- 6) Press the **BACK** Softkey to return to the previous softkey level.

Display Selection

Pressing the **HIDE MAP** Softkey removes the map and displays video on the full screen. The softkey label changes to grey with black characters. Pressing the **HIDE MAP** Softkey again restores the map view and the small video image. The softkey label returns to white characters on a black background.

Input Selection

While on the AUX - VIDEO Page, press the **INPUT** Softkey to select the EVS or AUX video source.

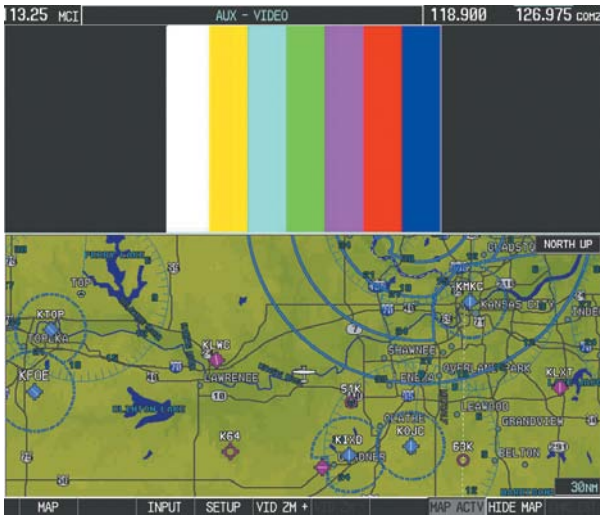

Figure 11-37 AUX - Video Split-Screen



Figure 11-38 Full Screen Video Display

Zoom/Range

Pressing the **VID ZM +** or **VID ZM -** Softkeys increases or decreases video display magnification between 1x and 10x.

The **RANGE** Knob can be used to increase or decrease the range setting on the map display or zoom in and out on the video display. While in the Split-Screen mode, pressing the **MAP ACTV** or **VID ACTV** Softkey determines which display the **RANGE** Knob adjusts. Pressing the softkey to display **MAP ACTV** allows the **RANGE** Knob to control the range setting of the map display. Pressing the softkey to display **VID ACTV** allows the **RANGE** Knob to control the zoom setting of the video display.

When zooming in on the video display, a Zoom Window will appear in the upper right of the display. A box within this window indicates the portion of the display currently being viewed. The currently displayed portion of the full display may be adjusted by using Joystick.

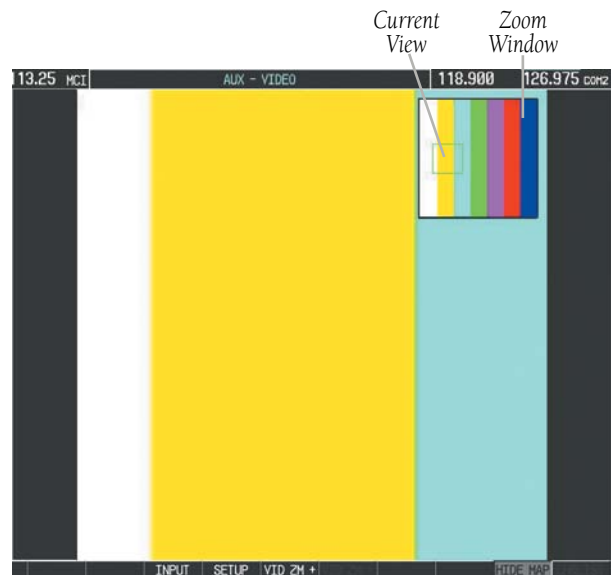

Figure 11-39 Zoom Window

SECTION 12: ABNORMAL OPERATION

12.1 REVERSIONARY MODE

Should a system detected failure occur in either display, the G1000 automatically enters Reversionary Mode. In Reversionary Mode, critical flight instrumentation is combined with engine instrumentation on the remaining display. Reduced navigation capability is available on the Reversionary Mode display.

Reversionary display mode can also be manually activated by the pilot if the system fails to detect a display problem. The Reversionary Mode is activated manually by pressing the red **DISPLAY BACKUP** Button on the bottom of the audio panel (GMA 1347). Pressing the red **DISPLAY BACKUP** Button again deactivates Reversionary Mode.



NOTE: *The Cessna Pilot's Operating Handbook (POH) always takes precedence over the information found in this section.*



Normal PFD Display



Normal MFD Display



MFD in Reversionary Mode

Figure 12-1 G1000 Reversionary Mode: Failed PFD

12.2 ABNORMAL COM OPERATION

When a COM tuning failure is detected by the system, the emergency frequency (121.500 MHz) is automatically loaded into the active frequency field of the COM radio for which the tuning failure was detected. In the event of a dual display failure, the emergency frequency (121.500 MHz) automatically becomes the active frequency to the pilot through the pilot headset.

12.3 UNUSUAL ATTITUDES

The PFD ‘declutters’ when the aircraft enters an unusual attitude. Only the primary functions are displayed in these situations.

The following information is removed from the PFD (and corresponding softkeys are disabled) when the aircraft experiences unusual attitudes:

- Traffic Annunciations
- AFCS Annunciations
- Flight Director Command Bars
- Inset Map
- Temperatures
- DME Information Window
- Wind Data
- Selected Heading Box
- Selected Course Box
- Transponder Status Box
- System Time
- PFD Setup Menu
- Windows displayed in the lower right corner of the PFD:
 - Timer/References
 - Nearest Airports
 - Flight Plan
 - Messages
 - Procedures
 - DME Tuning
- Barometric Minimum Descent Altitude Box
- Glideslope, Glidepath, and Vertical Deviation Indicators
- Altimeter Barometric Setting
- Selected Altitude
- VNV Target Altitude

Red extreme pitch warning chevrons pointing toward the horizon are displayed starting at 50 degrees above and 30 degrees below the horizon line.

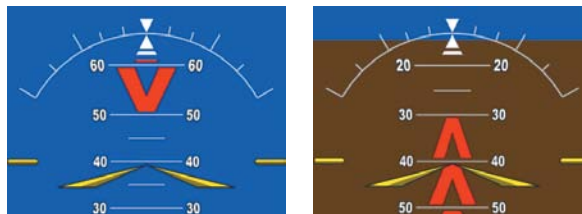

Figure 12-2 Extreme Pitch Indication

12.4 STORMSCOPE OPERATION WITH LOSS OF HEADING INPUT

If heading is lost, strikes and/or cells must be cleared manually after the execution of each turn. This is to ensure that the strike and/or cell positions are depicted accurately in relation to the nose of the aircraft.

12.5 HAZARD DISPLAYS WITH LOSS OF GPS POSITION

If GPS position is lost, or becomes invalid, selected hazards being displayed on the Navigation Map Page are removed until GPS position is again established. The icons in the lower right of the screen, indicating the selected functions for display, will show an ‘X’, as shown in Figure 12-3.



Figure 12-3 Loss of Hazard Functions with Loss of GPS Position

12.6 DEAD RECKONING



WARNING: *DR Mode is inherently less accurate than the standard GPS/SBAS Mode due to the lack of satellite measurements needed to determine a position. Changes in wind speed and/or wind direction compound the relative inaccuracy of DR Mode.*

While in Enroute or Oceanic phase of flight, if the G1000 detects an invalid GPS solution or is unable to calculate a GPS position, the system automatically reverts to Dead Reckoning (DR) Mode. In DR Mode, the G1000 uses its last-known position combined with continuously updated airspeed and heading data (when available) to calculate and display the aircraft's current estimated position.



NOTE: *Dead Reckoning Mode only functions in Enroute (ENR) or Oceanic (OCN) phase of flight. In all other phases, an invalid GPS solution produces a 'NO GPS POSITION' annunciation on the map and the G1000 stops navigating in GPS Mode.*

DR Mode is indicated on the G1000 by the appearance of the letters 'DR' superimposed in yellow over the 'own aircraft' symbol as shown in Figure 12-4. In addition, 'DR' is prominently displayed, also in yellow, on the HSI slightly above and to the right of the aircraft symbol on the CDI as shown in Figure 12-4. The CDI deviation bar is displayed in yellow, but will be removed from the display after 20 minutes. Lastly, but at the same time, a 'GPS NAV LOST' alert message appears on the PFD.

Normal navigation using GPS/SBAS source data resumes automatically once a valid GPS solution is restored.

It is important to note that estimated navigation data supplied by the G1000 in DR Mode may become increasingly unreliable and must not be used as a sole means of navigation. If while in DR Mode airspeed and/or heading data is also lost or not available, the DR function may not be capable of accurately tracking your estimated position and, consequently, the system may display a path that is different than the actual movement of the aircraft. Estimated position information displayed by the G1000 through DR while there is no heading and/or airspeed data available should not be used for navigation.



CDI 'DR' Indication on PFD

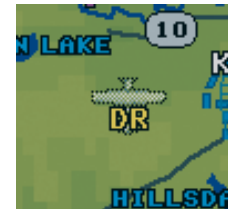

Symbolic Aircraft
(Map pages and Inset Map)

Figure 12-4 Dead Reckoning Indications

As a result of operating in DR Mode, all GPS-derived data is computed based upon an estimated position and is displayed as yellow text on the display to denote degraded navigation source information. This data includes the following:

- Navigation Status Box fields except Active Leg, TAS, and DTK
- GPS Bearing Pointer
- Wind data and pointers in the Wind Data Box on the PFD and MFD
- Current Track Indicator
- All Bearing Pointer Distances
- Active Flight Plan distances, bearings, and ETE values

Also, while the G1000 is in DR Mode, the autopilot will couple to GPS for up to 20 minutes. Terrain Proximity, TERRAIN-SVS, and TAWS are also disabled. Additionally, the accuracy of all nearest information (airports, airspaces, and waypoints) is questionable. Finally, airspace alerts continue to function, but with degraded accuracy.

SECTION 13: ANNUNCIATIONS & ALERTS



NOTE: The Cessna aircraft Pilot's Operating Handbook (POH) supersedes information found in this document.

The G1000 Alerting System conveys alerts to the pilot using a combination of the following items:

- **Annunciation Window:** The Annunciation Window displays abbreviated annunciation text. Text color is based on alert levels described later in the Alert Levels Definitions section. The Annunciation Window is located to the right of the Altimeter and Vertical Speed Indicator on the display. All Cessna Nav III annunciations can be displayed simultaneously in the Annunciation Window. A white horizontal line separates annunciations that are acknowledged from annunciations that are not yet acknowledged. Higher priority annunciations are displayed towards the top of the window. Lower priority annunciations are displayed towards the bottom of the window.
- **Alerts Window:** The Alerts Window displays alert text messages. Up to 64 prioritized alert messages can be displayed in the Alerts Window. Pressing the **ALERTS** Softkey displays the Alerts Window. Pressing the **ALERTS** Softkey a second time removes the Alerts Window from the display. When the Alerts Window is displayed, the pilot can use the large **FMS** Knob to scroll through the alert message list.

- **Softkey Annunciation:** During certain alerts, the **ALERTS** Softkey may appear as a flashing annunciation to accompany an alert. The **ALERTS** Softkey assumes a new label consistent with the alert level (WARNING, CAUTION, or ADVISORY). By pressing the softkey annunciation, the pilot acknowledges awareness of the alert. The softkey then returns to the previous **ALERTS** label. If alerts are still present, the **ALERTS** label is displayed in inverse video (white background with black text). The pilot can press the **ALERTS** Softkey a second time to view alert text messages.
- **System Annunciations:** Typically, a large red 'X' appears in windows when a failure is detected in the LRU providing the information to the window. See the G1000 System Annunciations section for more information.
- **Audio Alerting System:** The G1000 system issues audio alert tones when specific system conditions are met. See the Alert Levels Definitions section for more information.

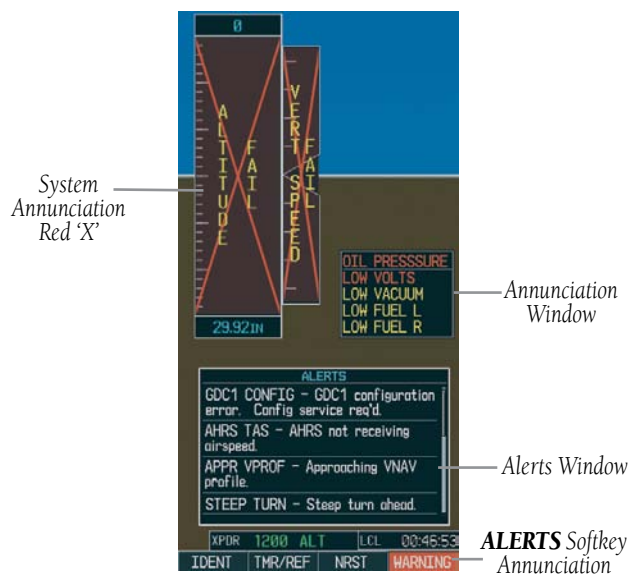

Figure 13-1 G1000 Alerting System

13.1 ALERT LEVEL DEFINITIONS

The G1000 Alerting System, as installed in Cessna Nav III aircraft, uses three alert levels.

- **WARNING:** This level of alert requires immediate pilot attention. A warning alert is annunciated in the Annunciation Window and is accompanied by a continuous aural tone. Text appearing in the Annunciation Window is RED. A warning alert is also accompanied by a flashing **WARNING** Softkey annunciation, as shown in Figure 13-2. Pressing the **WARNING** Softkey acknowledges the presence of the warning alert and stops the aural tone, if applicable.
- **CAUTION:** This level of alert indicates the existence of abnormal conditions on the aircraft that may require pilot intervention. A caution alert is annunciated in the Annunciation Window and is accompanied by a single aural tone. Text appearing in the Annunciation Window is YELLOW. A caution alert is also accompanied by a flashing **CAUTION** Softkey annunciation, as shown in Figure 13-3. Pressing the **CAUTION** Softkey acknowledges the presence of the caution alert.
- **MESSAGE ADVISORY:** This level of alert provides general information to the pilot. A message advisory alert does not issue annunciations in the Annunciation Window. Instead, message advisory alerts only issue a flashing **ADVISORY** Softkey annunciation, as shown in Figure 13-4. Pressing the **ADVISORY** Softkey acknowledges the presence of the message advisory alert and displays the alert text message in the Alerts Window.



Figure 13-2 WARNING Softkey Annunciation



Figure 13-3 CAUTION Softkey Annunciation



Figure 13-4 ADVISORY Softkey Annunciation

13.2 NAV III AIRCRAFT ALERTS

The following alerts are configured specifically for the Cessna Nav III aircraft. See the Cessna Pilot's Operating Handbook (POH) for information regarding pilot responses.

WARNING Alerts (172R, 172S, 182T, T182T, 206H, and T206H)

Annunciation Window Text	Audio Alert
CO LVL HIGH HIGH VOLTS LOW VOLTS* OIL PRESSURE PITCH TRIM**	Continuous Aural Tone
	No Tone

* Aural tone is inhibited while the aircraft is on the ground.

** KAP 140 installations only

CAUTION Alerts (172R, 172S, 182T, T182T, 206H, and T206H)

Annunciation Window Text	Audio Alert
LOW FUEL L LOW FUEL R LOW VACUUM STBY BATT	Single Aural Tone

CAUTION Alerts (T182, T206, and 206 with Prop De-Ice Only)

Annunciation Window Text	Audio Alert
PROP HEAT	Single Aural Tone

Safe Operating Annunciation (T182, T206, and 206 with Prop De-Ice Only)

Annunciation Window Text	Audio Alert
PROP HEAT	No Tone

13.3 CO GUARDIAN MESSAGES

Alerts Window Message	Comments
CO DET SRVC – The carbon monoxide detector needs service.	There is a problem within the CO Guardian that requires services.
CO DET FAIL – The carbon monoxide detector is inoperative.	Loss of communication between the G1000 and the CO Guardian.

13.4 AFCS ALERTS

System Status Annunciation

The following alert annunciations appear in the AFCS System Status Annunciation on the PFD.

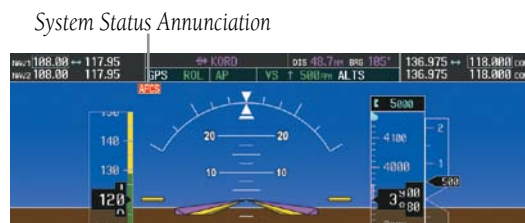











Figure 13-5 AFCS System Status Annunciation

Condition	Annunciation	Description
Pitch Failure		Pitch axis control failure. AP is inoperative.
Roll Failure		Roll axis control failure. AP is inoperative.
MET Switch Stuck, or Pitch Trim Axis Control Failure		If annunciated when AP is engaged, take control of the aircraft and disengage the autopilot. If annunciated when AP is not engaged, move each half of the MET switch separately to check if a stuck switch is causing the annunciation.
System Failure		AP and MET are unavailable. FD may still be available.
Elevator Mistrim Up		A condition has developed causing the pitch servo to provide a sustained force. Be prepared to apply nose up control wheel force upon autopilot disconnect.
Elevator Mistrim Down		A condition has developed causing the pitch servo to provide a sustained force. Be prepared to apply nose down control wheel force upon autopilot disconnect.
Aileron Mistrim Left		A condition has developed causing the roll servo to provide a sustained left force. Ensure the slip/skid indicator is centered and observe any maximum fuel imbalance limits.
Aileron Mistrim Right		A condition has developed causing the roll servo to provide a sustained right force. Ensure the slip/skid indicator is centered and observe any maximum fuel imbalance limits.
Preflight Test		Performing preflight system test. Upon completion of the test, the aural alert is heard.
		Preflight system test has failed.

13.5 TERRAIN-SVS ALERTS

The following table shows the possible Terrain-SVS alert types with corresponding annunciations and aural messages.

Alert Type	PFD/MFD Alert Annunciation	MFD Pop-Up Alert	Aural Message
Reduced Required Terrain Clearance Warning (RTC)	TERRAIN	WARNING - TERRAIN	"Warning; Terrain, Terrain"
Imminent Terrain Impact Warning (ITI)	TERRAIN	WARNING - TERRAIN	"Warning; Terrain, Terrain"
Reduced Required Obstacle Clearance Warning (ROC)	TERRAIN	WARNING - OBSTACLE	"Warning; Obstacle, Obstacle"
Imminent Obstacle Impact Warning (IOI)	TERRAIN	WARNING - OBSTACLE	"Warning; Obstacle, Obstacle"
Reduced Required Terrain Clearance Caution (RTC)	TERRAIN	CAUTION - TERRAIN	"Caution; Terrain, Terrain"
Imminent Terrain Impact Caution (ITI)	TERRAIN	CAUTION - TERRAIN	"Caution; Terrain, Terrain"
Reduced Required Obstacle Clearance Caution (ROC)	TERRAIN	CAUTION - OBSTACLE	"Caution; Obstacle, Obstacle"
Imminent Obstacle Impact Caution (IOI)	TERRAIN	CAUTION - OBSTACLE	"Caution; Obstacle, Obstacle"

The following system status annunciations may also be issued.

Alert Type	PFD/MFD Alert Annunciation	TERRAIN-SVS Page Annunciation	Aural Message
System Test in Progress	TER TEST	TERRAIN TEST	None
System Test Pass	None	None	"Terrain System Test OK"
Terrain Alerting is disabled	TER INH	None	None
MFD Terrain or Obstacle database unavailable or invalid. Terrain-SVS operating with PFD Terrain or Obstacle databases	None	TERRAIN DATABASE FAILURE	None
Terrain System Test Fail	TER FAIL	TERRAIN FAIL	"Terrain System Failure"
Terrain or Obstacle database unavailable or invalid, invalid software configuration, system audio fault	TER FAIL	TERRAIN FAIL	"Terrain System Failure"

Alert Type	PFD/MFD Alert Annunciation	TERRAIN-SVS Page Annunciation	Aural Message
No GPS position	TER N/A	NO GPS POSITION	"Terrain System Not Available"
Excessively degraded GPS signal, Out of database coverage area	TER N/A	None	"Terrain System Not Available"
Sufficient GPS signal received after loss	None	None	"Terrain System Available"

13.6 TAWS ALERTS

The following table shows the possible TAWS alert types with corresponding annunciations and aural messages.

Alert Type	PFD/MFD TAWS-B Page Annunciation	MFD Pop-Up Alert	Aural Message
Excessive Descent Rate Warning (EDR)	PULL UP	PULL-UP	"Pull Up"
Reduced Required Terrain Clearance Warning (RTC)	PULL UP	TERRAIN - PULL-UP or TERRAIN AHEAD - PULL-UP	"Terrain, Terrain; Pull Up, Pull Up" or "Terrain Ahead, Pull Up; Terrain Ahead, Pull Up"
Imminent Terrain Impact Warning (ITI)	PULL UP	TERRAIN AHEAD - PULL-UP or TERRAIN - PULL-UP	Terrain Ahead, Pull Up; Terrain Ahead, Pull Up" or "Terrain, Terrain; Pull Up, Pull Up"
Reduced Required Obstacle Clearance Warning (ROC)	PULL UP	OBSTACLE - PULL-UP or OBSTACLE AHEAD - PULL-UP	"Obstacle, Obstacle; Pull Up, Pull Up" or "Obstacle Ahead, Pull Up; Obstacle Ahead, Pull Up"
Imminent Obstacle Impact Warning (IOI)	PULL UP	OBSTACLE AHEAD - PULL-UP or OBSTACLE - PULL-UP	"Obstacle Ahead, Pull Up; Obstacle Ahead, Pull Up" or "Obstacle, Obstacle; Pull Up, Pull Up"
Reduced Required Terrain Clearance Caution (RTC)	TERRAIN	CAUTION - TERRAIN or TERRAIN AHEAD	"Caution, Terrain; Caution, Terrain" or "Terrain Ahead; Terrain Ahead"
Imminent Terrain Impact Caution (ITI)	TERRAIN	TERRAIN AHEAD or CAUTION - TERRAIN	"Terrain Ahead; Terrain Ahead" or "Caution, Terrain; Caution, Terrain"
Reduced Required Obstacle Clearance Caution (ROC)	TERRAIN	CAUTION - OBSTACLE or OBSTACLE AHEAD	"Caution, Obstacle; Caution, Obstacle" or "Obstacle Ahead; Obstacle Ahead"
Imminent Obstacle Impact Caution (IOI)	TERRAIN	OBSTACLE AHEAD or CAUTION - OBSTACLE	"Obstacle Ahead; Obstacle Ahead" or "Caution, Obstacle; Caution, Obstacle"

Alert Type	PFD/MFD TAWS-B Page Annunciation	MFD Pop-Up Alert	Aural Message
Premature Descent Alert Caution (PDA)	TERRAIN	TOO LOW – TERRAIN	“Too Low, Terrain”
Altitude Callout “500”	None	None	“Five-Hundred”
Excessive Descent Rate Caution (EDR)	TERRAIN	SINK RATE	“Sink Rate”
Negative Climb Rate Caution (NCR)	TERRAIN	DON'T SINK or TOO LOW – TERRAIN	“Don't Sink” or “Too Low, Terrain”

TAWS SYSTEM STATUS ANNUNCIATIONS

Alert Type	PFD/MFD Alert Annunciation	TERRAIN-SVS Page Annunciation	Aural Message
System Test in Progress	TAWS TEST	TAWS TEST	None
System Test Pass	None	None	“TAWS System Test OK”
MFD Terrain or Obstacle database unavailable or invalid. TAWS operating with PFD Terrain or Obstacle databases	None	TERRAIN DATABASE FAILURE	None
TAWS-B System Test Fail	TAWS FAIL	TAWS FAIL	“TAWS System Failure”
Terrain or Obstacle database unavailable or invalid, invalid software configuration, system audio fault	TAWS FAIL	TAWS FAIL	“TAWS System Failure”
No GPS position	TAWS N/A	NO GPS POSITION	“TAWS Not Available”
Excessively degraded GPS signal, Out of database coverage area	TAWS N/A	None	“TAWS Not Available”
Sufficient GPS signal received after loss	None	None	“TAWS Available”

13.7 OTHER G1000 AURAL ALERTS





Aural Alert	Description
"Minimums, minimums"	The aircraft has descended below the preset barometric minimum descent altitude.
"Vertical track"	The aircraft is one minute from Top of Descent. Issued only when vertical navigation is enabled.
"Traffic"	The Traffic Information Service (TIS) or ADS-B traffic system has issued a Traffic Advisory alert
"Traffic not available"	The aircraft is outside the Traffic Information Service (TIS) or ADS-B coverage area.
"Traffic, Traffic"	Played when a Traffic Advisory (TA) is issued (TAS system).
"One o'clock" through "Twelve o'clock" or "No Bearing"	Played to indicate bearing of traffic from own aircraft (GTS 800 only).
"High", "Low", "Same Altitude" (if within 200 feet of own altitude), or "Altitude not available"	Played to indicate altitude of traffic relative to own aircraft (GTS 800 only).
"Less than one mile", "One Mile" through "Ten Miles", or "More than ten miles"	Played to indicate distance of traffic from own aircraft (GTS 800 only).

13.8 G1000 SYSTEM ANNUNCIATIONS





When an LRU or an LRU function fails, a large red 'X' is typically displayed on areas associated with the failed data. Refer to the POH for additional information regarding pilot responses to these annunciations.



NOTE: Upon power-up of the G1000 system, certain boxes remain invalid as G1000 equipment begins to initialize. All boxes should be operational within one minute of power-up. Should any box continue to remain flagged, the G1000 system should be serviced by a Garmin-authorized repair facility.

System Annunciation	Comment
	Attitude and Heading Reference System is aligning.
	Display system is not receiving attitude information from the AHRS.
	Indicates a configuration module failure.
	This annunciation is only seen when the autopilot is engaged. The annunciation indicates an AHRS monitor has detected an abnormal flight parameter, possibly caused by strong turbulence. In this case, the situation should correct itself within a few seconds. If there is an actual failure, a red "X" soon appears over the Attitude Indicator.
	Display system is not receiving airspeed input from air data computer.

SECTION 13 – ANNUNCIATIONS & ALERTS

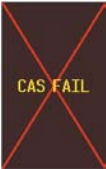
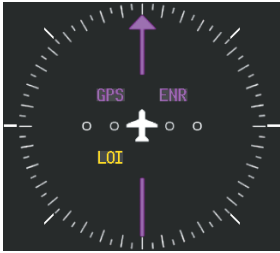
System Annunciation	Comment
	<p>Display is not receiving altitude input from the air data computer.</p>
	<p>Display is not receiving vertical speed input from the air data computer.</p>
	<p>Display is not receiving valid heading input from AHRS.</p>
	<p>Display is not receiving valid transponder information.</p>
	<p>Different versions of GDU software are installed in the PFD and MFD. This can also indicate different versions of navigation databases are installed in the PFD and MFD. In some circumstances, a cross-talk error between the PFD and MFD can cause this annunciation.</p>
	<p>'LOI' Indicates Loss of Integrity of GPS information. GPS information is either not present or is invalid for navigation use. 'DR' may also be seen indicating that GPS is in Dead Reckoning Mode. Note that AHRS utilizes GPS inputs during normal operation. AHRS operation may be degraded if GPS signals are not present (see AFMS).</p>
<p>Other Various Red X Indications</p>	<p>A red 'X' through any other display field, such as engine instrumentation fields, indicates that the field is not receiving valid data.</p>

A red 'X' may be the result of an LRU or an LRU function failure. The Figure 13-6 illustrates all possible flags and the responsible LRUs.

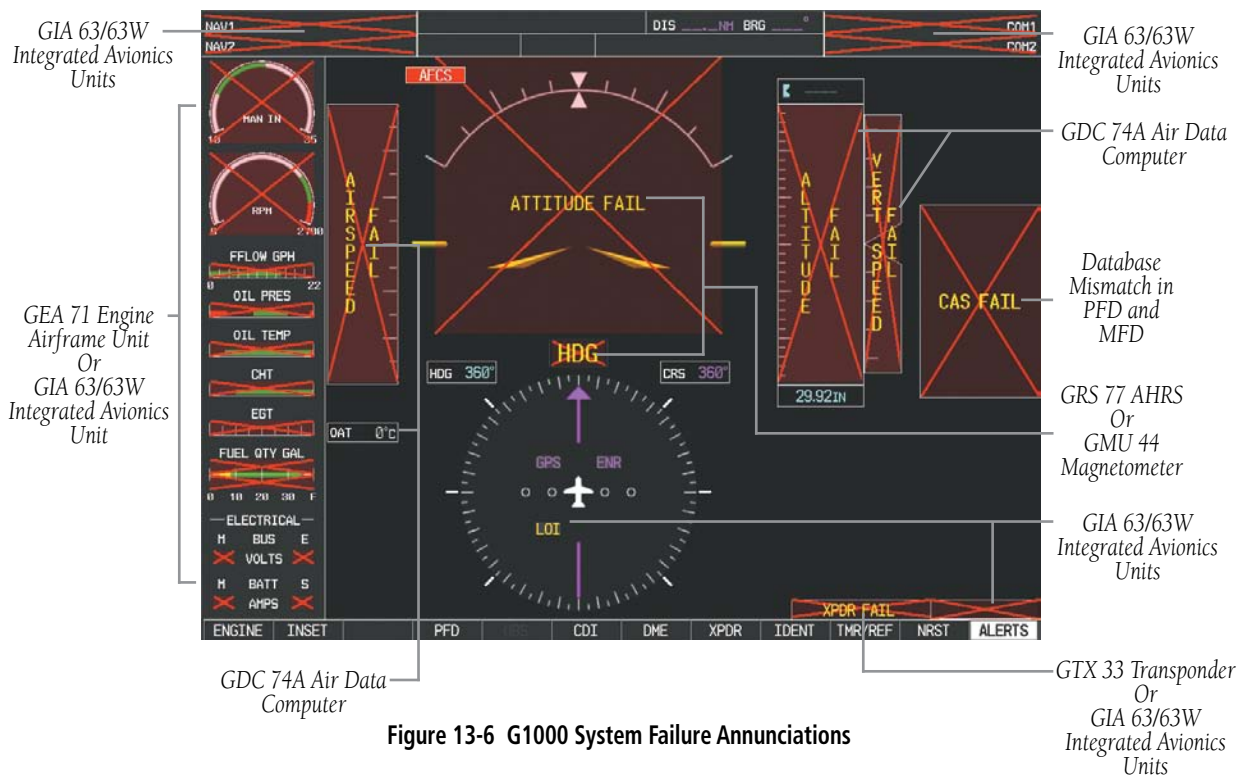

Figure 13-6 G1000 System Failure Annunciations

13.9 G1000 SYSTEM MESSAGE ADVISORIES

This section describes various G1000 system message advisories. Certain messages are issued due to an LRU or an LRU function failure. Such messages are normally accompanied by a corresponding red 'X' annunciation as shown previously in the G1000 System Annunciation section.



NOTE: This section provides information regarding G1000 message advisories that may be displayed by the system. Knowledge of the aircraft, systems, flight conditions, and other existing operational priorities must be considered when responding to a message. Always use sound pilot judgment. The Cessna aircraft Pilot's Operating Handbook (POH) takes precedence over any conflicting guidance found in this section.

MFD & PFD Message Advisories

Message	Comments
DATA LOST – Pilot stored data was lost. Recheck settings.	The pilot profile data was lost. System reverts to default pilot profile and settings. The pilot may reconfigure the MFD & PFDs with preferred settings, if desired.
XTALK ERROR – A flight display crosstalk error has occurred.	The MFD and PFD are not communicating with each other. The system should be serviced.
PFD1 SERVICE – PFD1 needs service. Return unit for repair.	The PFD and/or MFD self-test has detected a problem. The system should be serviced.
MFD1 SERVICE – MFD1 needs service. Return unit for repair.	
MANIFEST – PFD1 software mismatch, communication halted.	The PFD and/or MFD has incorrect software installed. The system should be serviced.
MANIFEST – MFD1 software mismatch, communication halted.	
PFD1 CONFIG – PFD1 config error. Config service req'd.	The PFD configuration settings do not match backup configuration memory. The system should be serviced.
MFD1 CONFIG – MFD1 config error. Config service req'd.	The MFD configuration settings do not match backup configuration memory. The system should be serviced.
SW MISMATCH – GDU software version mismatch. Xtalk is off.	The MFD and PFD have different software versions installed. The system should be serviced.
PFD1 COOLING – PFD1 has poor cooling. Reducing power usage.	The PFD and/or MFD is overheating and is reducing power consumption by dimming the display. If problem persists, the system should be serviced.
MFD1 COOLING – MFD1 has poor cooling. Reducing power usage.	

MFD & PFD Message Advisories (Cont.)

Message	Comments
PFD1 KEYSTK – PFD1 [key name] Key is stuck.	A key is stuck on the PFD and/or MFD bezel. Attempt to free the stuck key by pressing it several times. The system should be serviced if the problem persists.
MFD1 KEYSTK – MFD [key name] Key is stuck.	
CNFG MODULE – PFD1 configuration module is inoperative.	The PFD1 configuration module backup memory has failed. The system should be serviced.
PFD1 VOLTAGE – PFD1 has low voltage. Reducing power usage	The PFD1 voltage is low. The system should be serviced.
MFD1 VOLTAGE – MFD1 has low voltage. Reducing power usage	The MFD voltage is low. The system should be serviced.

Database Message Advisories

Message	Comments
MFD1 DB ERR – MFD1 navigation database error exists.	The MFD and/or PFD detected a failure in the navigation database. Attempt to reload the navigation database. If problem persists, the system should be serviced.
PFD1 DB ERR – PFD1 navigation database error exists.	
MFD1 DB ERR – MFD1 basemap database error exists.	The MFD and/or PFD detected a failure in the basemap database.
PFD1 DB ERR – PFD1 basemap database error exists.	
MFD1 DB ERR – MFD1 terrain database error exists.	The MFD and/or PFD detected a failure in the terrain database. Ensure that the terrain card is properly inserted in display. Replace terrain card. If problem persists, the system should be serviced.
PFD1 DB ERR – PFD1 terrain database error exists.	
MFD1 DB ERR – MFD1 terrain database missing.	The terrain database is present on another LRU, but is missing on the specified LRU.
PFD1 DB ERR – PFD1 terrain database missing.	

Database Message Advisories (Cont.)

Message	Comments
MFD1 DB ERR – MFD1 obstacle database error exists.	The MFD and/or PFD detected a failure in the obstacle database. Ensure that the data card is properly inserted. Replace data card. If problem persists, the system should be serviced.
PFD1 DB ERR – PFD1 obstacle database error exists.	
MFD1 DB ERR – MFD1 obstacle database missing.	The obstacle database is present on another LRU, but is missing on the specified LRU.
PFD1 DB ERR – PFD1 obstacle database missing.	
MFD1 DB ERR – MFD1 airport terrain database error exists.	The MFD and/or PFD detected a failure in the airport terrain database. Ensure that the data card is properly inserted. Replace data card. If problem persists, the system should be serviced.
PFD1 DB ERR – PFD1 airport terrain database error exists.	
MFD1 DB ERR – MFD1 airport terrain database missing.	The airport terrain database is present on another LRU, but is missing on the specified LRU.
PFD1 DB ERR – PFD1 airport terrain database missing.	
MFD1 DB ERR – MFD1 Safe Taxi database error exists.	The MFD and/or PFD detected a failure in the Safe Taxi database. Ensure that the data card is properly inserted. Replace data card. If problem persists, the system should be serviced.
PFD1 DB ERR – PFD1 Safe Taxi database error exists.	
MFD1 DB ERR – MFD1 Chartview database error exists.	The MFD detected a failure in the ChartView database (optional feature). Ensure the data card is properly inserted. Replace data card. If problem persists, system should be serviced.
MFD1 DB ERR – MFD1 FliteCharts database error exists.	The MFD detected a failure in the FliteCharts database (optional feature). Ensure the data card is properly inserted. Replace data card. If problem persists, system should be serviced.
MFD1 DB ERR – MFD1 Airport Directory database error exists.	The MFD detected a failure in the Airport Directory database. Ensure that the data card is properly inserted. Replace data card. If problem persists, the system should be serviced.

Database Message Advisories (Cont.)

Message	Comments
DB MISMATCH – Navigation database mismatch. Xtalk is off.	The PFD and MFD have different navigation database versions or regions installed. Crossfill is off. Check the AUX-SYSTEM STATUS Page to determine versions or regions. Also, check the AUX-SYSTEM STATUS Page for a database synchronization function not completed. After synchronization is complete, power must be turned off, then on.
DB MISMATCH – Terrain database mismatch.	The PFD and MFD have different terrain database versions or regions installed. Check the AUX-SYSTEM STATUS Page to determine versions or regions. Also, check the AUX-SYSTEM STATUS Page for a database synchronization function not completed. After synchronization is complete, power must be turned off, then on.
DB MISMATCH – Obstacle database mismatch.	The PFD and MFD have different obstacle database versions or regions installed. Check the AUX-SYSTEM STATUS Page to determine versions or regions. Also, check the AUX-SYSTEM STATUS Page for a database synchronization function not completed. After synchronization is complete, power must be turned off, then on.
DB MISMATCH – Airport Terrain database mismatch.	The PFD and MFD have different airport terrain database versions or regions installed. Check the AUX-SYSTEM STATUS Page to determine versions or regions. Also, check the AUX-SYSTEM STATUS Page for a database synchronization function not completed. After synchronization is complete, power must be turned off, then on.
DB MISMATCH – Standby Navigation database mismatch.	The PFD and MFD have different standby navigation database versions or regions installed. Check the AUX-SYSTEM STATUS Page to determine versions or regions. Also, check the AUX-SYSTEM STATUS Page for a database synchronization function not completed. After synchronization is complete, power must be turned off, then on.
NAV DB UPDATED – Active navigation database updated.	System has updated the active navigation database from the standby navigation database.
TERRAIN DSP – [PFD1 or MFD1] Terrain awareness display unavailable.	One of the terrain, airport terrain, or obstacle databases required for TAWS in the specified PFD or MFD is missing or invalid.

GMA 1347 Message Advisories

Message	Comments
GMA1 FAIL – GMA1 is inoperative.	The audio panel self-test has detected a failure. The audio panel is unavailable. The system should be serviced.
GMA1 CONFIG – GMA1 config error. Config service req'd.	The audio panel configuration settings do not match backup configuration memory. The system should be serviced.
MANIFEST – GMA1 software mismatch, communication halted.	The audio panel has incorrect software installed. The system should be serviced.
GMA1 SERVICE – GMA1 needs service. Return unit for repair.	The audio panel self-test has detected a problem in the unit. Certain audio functions may still be available, and the audio panel may still be usable. The system should be serviced when possible.

GIA 63 Message Advisories

Message	Comments
GIA1 CONFIG – GIA1 config error. Config service req'd.	The GIA1 and/or GIA2 configuration settings do not match backup configuration memory. The G1000 system should be serviced.
GIA2 CONFIG – GIA2 config error. Config service req'd.	
GIA1 CONFIG – GIA1 audio config error. Config service req'd.	The GIA1 and/or GIA2 have an error in the audio configuration. The G1000 system should be serviced.
GIA2 CONFIG – GIA2 audio config error. Config service req'd.	
GIA1 COOLING – GIA1 temperature too low.	The GIA1 and/or GIA2 temperature is too low to operate correctly. Allow units to warm up to operating temperature.
GIA2 COOLING – GIA2 temperature too low.	
GIA1 COOLING – GIA1 over temperature.	The GIA1 and/or GIA2 temperature is too high. If problem persists, the G1000 system should be serviced.
GIA2 COOLING – GIA2 over temperature.	
GIA1 SERVICE – GIA1 needs service. Return the unit for repair.	The GIA1 and/or GIA2 self-test has detected a problem in the unit. The G1000 system should be serviced.
GIA2 SERVICE – GIA2 needs service. Return the unit for repair.	

GIA 63 Message Advisories (Cont.)

Message	Comments
MANIFEST – GIA1 software mismatch, communication halted.	The GIA1 and/or GIA 2 has incorrect software installed. The G1000 system should be serviced.
MANIFEST – GIA2 software mismatch, communication halted.	
COM1 TEMP – COM1 over temp. Reducing transmitter power.	The system has detected an over temperature condition in COM1 and/or COM2. The transmitter is operating at reduced power. If the problem persists, the G1000 system should be serviced.
COM2 TEMP – COM2 over temp. Reducing transmitter power.	
COM1 SERVICE – COM1 needs service. Return unit for repair.	The system has detected a failure in COM1 and/or COM2. COM1 and/or COM2 may still be usable. The G1000 system should be serviced when possible.
COM2 SERVICE – COM2 needs service. Return unit for repair.	
COM1 PTT – COM1 push-to-talk key is stuck.	The COM1 and/or COM2 external push-to-talk switch is stuck in the enable (or “pressed”) position. Press the PTT switch again to cycle its operation. If the problem persists, the G1000 system should be serviced.
COM2 PTT – COM2 push-to-talk key is stuck.	
COM1 RMT XFR – COM1 remote transfer key is stuck.	The COM1 and/or COM2 transfer switch is stuck in the enabled (or “pressed”) position. Press the transfer switch again to cycle its operation. If the problem persists, the G1000 system should be serviced.
COM2 RMT XFR – COM2 remote transfer key is stuck.	
RAIM UNAVAIL – RAIM is not available from FAF to MAP waypoints.	GPS satellite coverage is insufficient to perform Receiver Autonomous Integrity Monitoring (RAIM) from the FAF to the MAP waypoints.
LOI – GPS integrity lost. Crosscheck with other NAVS.	Loss of GPS integrity monitoring.
GPS NAV LOST – Loss of GPS navigation. Insufficient satellites.	Loss of GPS navigation due to insufficient satellites.
GPS NAV LOST – Loss of GPS navigation. Position error.	Loss of GPS navigation due to position error.
GPS NAV LOST – Loss of GPS navigation. GPS fail.	Loss of GPS navigation due to GPS failure.

GIA 63 Message Advisories (Cont.)

Message	Comments
ABORT APR – Loss of GPS navigation. Abort approach.	Abort approach due to loss of GPS navigation.
TRUE APR – True north approach. Change hdg reference to TRUE.	Displayed after passing the first waypoint of a true north approach when the nav angle is set to 'AUTO'.
GPS1 FAIL – GPS1 is inoperative.	A failure has been detected in the GPS1 and/or GPS2 receiver. The receiver is unavailable. The G1000 system should be serviced.
GPS2 FAIL – GPS2 is inoperative.	
GPS1 SERVICE – GPS1 needs service. Return unit for repair.	A failure has been detected in the GPS1 and/or GPS2 receiver. The receiver may still be available. The G1000 system should be serviced.
GPS2 SERVICE – GPS2 needs service. Return unit for repair.	
NAV1 SERVICE – NAV1 needs service. Return unit for repair.	A failure has been detected in the NAV1 and/or NAV2 receiver. The receiver may still be available. The G1000 system should be serviced.
NAV2 SERVICE – NAV2 needs service. Return unit for repair.	
NAV1 RMT XFR – NAV1 remote transfer key is stuck.	The remote NAV1 and/or NAV2 transfer switch is stuck in the enabled (or "pressed") state. Press the transfer switch again to cycle its operation. If the problem persists, the G1000 system should be serviced.
NAV2 RMT XFR – NAV2 remote transfer key is stuck.	
G/S1 FAIL – G/S1 is inoperative.	A failure has been detected in glideslope receiver 1 and/or receiver 2. The G1000 system should be serviced.
G/S2 FAIL – G/S2 is inoperative.	
G/S1 SERVICE – G/S1 needs service. Return unit for repair.	A failure has been detected in glideslope receiver 1 and/or receiver 2. The receiver may still be available. The G1000 system should be serviced when possible.
G/S2 SERVICE – G/S2 needs service. Return unit for repair.	

GIA 63W Message Advisories

Message	Comments
GIA1 CONFIG – GIA1 config error. Config service req'd.	The GIA1 and/or GIA2 configuration settings do not match backup configuration memory. The system should be serviced.
GIA2 CONFIG – GIA2 config error. Config service req'd.	
GIA1 CONFIG – GIA1 audio config error. Config service req'd.	The GIA1 and/or GIA2 have an error in the audio configuration. The system should be serviced.
GIA2 CONFIG – GIA2 audio config error. Config service req'd.	
GIA1 COOLING – GIA1 temperature too low.	The GIA1 and/or GIA2 temperature is too low to operate correctly. Allow units to warm up to operating temperature.
GIA2 COOLING – GIA2 temperature too low.	
GIA1 COOLING – GIA1 over temperature.	The GIA1 and/or GIA2 temperature is too high. If problem persists, the system should be serviced.
GIA2 COOLING – GIA2 over temperature.	
GIA1 SERVICE – GIA1 needs service. Return the unit for repair.	The GIA1 and/or GIA2 self-test has detected a problem in the unit. The system should be serviced.
GIA2 SERVICE – GIA2 needs service. Return the unit for repair.	
HW MISMATCH – GIA hardware mismatch. GIA1 communication halted.	A GIA mismatch has been detected, where only one is SBAS capable.
HW MISMATCH – GIA hardware mismatch. GIA2 communication halted.	

GIA 63W Message Advisories (Cont.)

Message	Comments
MANIFEST – GIA1 software mismatch, communication halted.	The GIA1 and/or GIA 2 has incorrect software installed. The system should be serviced.
MANIFEST – GIA2 software mismatch, communication halted.	
MANIFEST – GFC software mismatch, communication halted.	Incorrect servo software is installed, or gain settings are incorrect.
MANIFEST – COM1 software mismatch, communication halted.	COM1 and/or COM2 software mismatch. The G1000 system should be serviced.
MANIFEST – COM2 software mismatch, communication halted.	
MANIFEST – NAV1 software mismatch, communication halted.	NAV1 and/or NAV2 software mismatch. The G1000 system should be serviced.
MANIFEST – NAV2 software mismatch, communication halted.	
COM1 TEMP – COM1 over temp. Reducing transmitter power.	The system has detected an over temperature condition in COM1 and/or COM2. The transmitter is operating at reduced power. If the problem persists, the system should be serviced.
COM2 TEMP – COM2 over temp. Reducing transmitter power.	
COM1 CONFIG – COM1 config error. Config service req'd.	COM1 and/or COM2 configuration settings do not match backup configuration memory. The G1000 system should be serviced.
COM2 CONFIG – COM2 config error. Config service req'd.	
COM1 TEMP – COM1 over temp. Reducing transmitter power.	The system has detected an over temperature condition in COM1 and/or COM2. The transmitter is operating at reduced power. If the problem persists, the G1000 system should be serviced.
COM2 TEMP – COM2 over temp. Reducing transmitter power.	
COM1 SERVICE – COM1 needs service. Return unit for repair.	The system has detected a failure in COM1 and/or COM2. COM1 and/or COM2 may still be usable. The system should be serviced when possible.
COM2 SERVICE – COM2 needs service. Return unit for repair.	

GIA 63W Message Advisories (Cont.)

Message	Comments
COM1 PTT – COM1 push-to-talk key is stuck.	The COM1 and/or COM2 external push-to-talk switch is stuck in the enable (or “pressed”) position. Press the PTT switch again to cycle its operation. If the problem persists, the system should be serviced.
COM2 PTT – COM2 push-to-talk key is stuck.	
COM1 RMT XFR – COM1 remote transfer key is stuck.	The COM1 and/or COM2 transfer switch is stuck in the enabled (or “pressed”) position. Press the transfer switch again to cycle its operation. If the problem persists, the system should be serviced.
COM2 RMT XFR – COM2 remote transfer key is stuck.	
LOI – GPS integrity lost. Crosscheck with other NAVS.	GPS integrity is insufficient for the current phase of flight.
GPS NAV LOST – Loss of GPS navigation. Insufficient satellites.	Loss of GPS navigation due to insufficient satellites.
GPS NAV LOST – Loss of GPS navigation. Position error.	Loss of GPS navigation due to position error.
GPS NAV LOST – Loss of GPS navigation. GPS fail.	Loss of GPS navigation due to GPS failure.
ABORT APR – Loss of GPS navigation. Abort approach.	Abort approach due to loss of GPS navigation.
APR DWNGRADE – Approach downgraded.	Vertical guidance generated by SBAS is unavailable, use LNAV only minimums.
TRUE APR – True north approach. Change HDG reference to TRUE.	Displayed after passing the first waypoint of a true north approach when the nav angle is set to ‘AUTO’.
GPS1 SERVICE – GPS1 needs service. Return unit for repair.	A failure has been detected in the GPS1 and/or GPS2 receiver. The receiver may still be available. The system should be serviced.
GPS2 SERVICE – GPS2 needs service. Return unit for repair.	
NAV1 SERVICE – NAV1 needs service. Return unit for repair.	A failure has been detected in the NAV1 and/or NAV2 receiver. The receiver may still be available. The system should be serviced.
NAV2 SERVICE – NAV2 needs service. Return unit for repair.	

GIA 63W Message Advisories (Cont.)

Message	Comments
NAV1 RMT XFR – NAV1 remote transfer key is stuck.	The remote NAV1 and/or NAV2 transfer switch is stuck in the enabled (or “pressed”) state. Press the transfer switch again to cycle its operation. If the problem persists, the system should be serviced.
NAV2 RMT XFR – NAV2 remote transfer key is stuck.	
G/S1 FAIL – G/S1 is inoperative.	A failure has been detected in glideslope receiver 1 and/or receiver 2. The system should be serviced.
G/S2 FAIL – G/S2 is inoperative.	
G/S1 SERVICE – G/S1 needs service. Return unit for repair.	A failure has been detected in glideslope receiver 1 and/or receiver 2. The receiver may still be available. The system should be serviced when possible.
G/S2 SERVICE – G/S2 needs service. Return unit for repair.	
FAILED PATH – A data path has failed.	A data path connected to the GDU or the GIA 63/W has failed.

GEA 71 Message Advisories

Message	Comments
GEA1 CONFIG – GEA1 config error. Config service req'd.	The GEA1 configuration settings do not match those of backup configuration memory. The G1000 system should be serviced.
MANIFEST – GEA1 software mismatch, communication halted.	The #1 GEA 71 has incorrect software installed. The G1000 system should be serviced.

GSR 56 Message Advisories

Message	Comments
GSR1 FAIL – GSR1 has failed.	A failure has been detected in the #1 GSR 56. The system should be serviced.

GDC 74A Message Advisories

Message	Comments
ADC1 ALT EC – ADC1 altitude error correction is unavailable.	GDC1 is reporting that the altitude error correction is unavailable.
ADC1 AS EC – ADC1 airspeed error correction is unavailable.	GDC1 is reporting that the airspeed error correction is unavailable.
MANIFEST – GDC1 software mismatch, communication halted.	The GDC 74A has incorrect software installed. The G1000 system should be serviced.

GTX 33 Message Advisories

Message	Comments
XPDR1 CONFIG – XPDR1 config error. Config service req'd.	The transponder configuration settings do not match those of backup configuration memory. The system should be serviced.
MANIFEST – GTX1 software mismatch, communication halted.	The transponder has incorrect software installed. The system should be serviced.
XPDR1 SRVC – XPDR1 needs service. Return unit for repair.	The #1 transponder should be serviced when possible.
XPDR1 FAIL – XPDR1 is inoperative.	There is no communication with the #1 transponder.

GRS 77 Message Advisories

Message	Comments
AHRS1 TAS – AHRS1 not receiving airspeed.	The #1 AHRS is not receiving true airspeed from the air data computer. The AHRS relies on GPS information to augment the lack of airspeed. The system should be serviced.
AHRS1 GPS – AHRS1 using backup GPS source.	The #1 AHRS is using the backup GPS path. Primary GPS path has failed. The system should be serviced when possible.
AHRS1 GPS – AHRS1 not receiving any GPS information.	The #1 AHRS is not receiving any or any useful GPS information. Check AFMS limitations. The system should be serviced.
AHRS1 GPS – AHRS1 not receiving backup GPS information.	The #1 AHRS is not receiving backup GPS information. The system should be serviced.
AHRS1 GPS – AHRS1 operating exclusively in no-GPS mode.	The #1 AHRS is operating exclusively in no-GPS mode. The system should be serviced.
AHRS1 SRVC – AHRS1 Magnetic-field model needs update.	The #1 AHRS earth magnetic field model is out of date. Update magnetic field model when practical.
GEO LIMITS – AHRS1 too far North/South, no magnetic compass.	The aircraft is outside geographical limits for approved AHRS operation. Heading is flagged as invalid.
MANIFEST – GRS1 software mismatch, communication halted.	The #1 AHRS has incorrect software installed. The system should be serviced.

GMU 44 Message Advisories

Message	Comments
HDG FAULT – AHRS1 magnetometer fault has occurred.	A fault has occurred in the #1 GMU 44. Heading is flagged as invalid. The AHRS uses GPS for backup mode operation. The G1000 system should be serviced.
MANIFEST – GMU1 software mismatch, communication halted.	The GMU 44 has incorrect software installed. The G1000 system should be serviced.

GDL 69/69A Message Advisories

Message	Comments
GDL69 CONFIG – GDL 69 config error. Config service req'd.	GDL 69 configuration settings do not match those of backup configuration memory. The G1000 system should be serviced.
GDL69 FAIL – GDL 69 has failed.	A failure has been detected in the GDL 69. The receiver is unavailable. The G1000 system should be serviced
MANIFEST – GDL software mismatch, communication halted.	The GDL 69 has incorrect software installed. The G1000 system should be serviced.

Miscellaneous Message Advisories

Message	Comments
FPL WPT LOCK – Flight plan waypoint is locked.	Upon power-up, the system detects that a stored flight plan waypoint is locked. This occurs when an navigation database update eliminates an obsolete waypoint. The flight plan cannot find the specified waypoint and flags this message. This can also occur with user waypoints in a flight plan that is deleted. Remove the waypoint from the flight plan if it no longer exists in any database, Or update the waypoint name/identifier to reflect the new information.
FPL WPT MOVE – Flight plan waypoint moved.	The system has detected that a waypoint coordinate has changed due to a new navigation database update. Verify that stored flight plans contain correct waypoint locations.
TIMER EXPIRD – Timer has expired.	The system notifies the pilot that the timer has expired.
DB CHANGE – Database changed. Verify user modified procedures.	This occurs when a stored flight plan contains procedures that have been manually edited. This alert is issued only after an navigation database update. Verify that the user-modified procedures in stored flight plans are correct and up to date.
DB CHANGE – Database changed. Verify stored airways.	This occurs when a stored flight plan contains an airway that is no longer consistent with the navigation database. This alert is issued only after an navigation database update. Verify use of airways in stored flight plans and reload airways as needed.

Miscellaneous Message Advisories (Cont.)

Message	Comments
FPL TRUNC – Flight plan has been truncated.	This occurs when a newly installed navigation database eliminates an obsolete approach or arrival used by a stored flight plan. The obsolete procedure is removed from the flight plan. Update flight plan with current arrival or approach.
LOCKED FPL – Cannot navigate locked flight plan.	This occurs when the pilot attempts to activate a stored flight plan that contains locked waypoint. Remove locked waypoint from flight plan. Update flight plan with current waypoint.
WPT ARRIVAL – Arriving at waypoint -[xxxx]	Arriving at waypoint [xxxx], where [xxxx] is the waypoint name.
STEEP TURN – Steep turn ahead.	A steep turn is 15 seconds ahead. Prepare to turn.
INSIDE ARSPC – Inside airspace.	The aircraft is inside the airspace.
ARSPC AHEAD – Airspace ahead less than 10 minutes.	Special use airspace is ahead of aircraft. The aircraft will penetrate the airspace within 10 minutes.
ARSPC NEAR – Airspace near and ahead.	Special use airspace is near and ahead of the aircraft position.
ARSPC NEAR – Airspace near – less than 2 nm.	Special use airspace is within 2 nm of the aircraft position.
APR INACTV – Approach is not active.	The system notifies the pilot that the loaded approach is not active. Activate approach when required.
SLCT FREQ – Select appropriate frequency for approach.	The system notifies the pilot to load the approach frequency for the appropriate NAV receiver. Select the correct frequency for the approach.
SLCT NAV – Select NAV on CDI for approach.	The system notifies the pilot to set the CDI to the correct NAV receiver. Set the CDI to the correct NAV receiver.
PTK FAIL – Parallel track unavailable: bad geometry.	Bad parallel track geometry.
PTK FAIL – Parallel track unavailable: past IAF.	IAF waypoint for parallel offset has been passed.
PTK FAIL – Parallel track unavailable: past IAF.	IAF waypoint for parallel offset has been passed.
UNABLE V WPT – Can't reach current vertical waypoint.	The current vertical waypoint can not be reached within the maximum flight path angle and vertical speed constraints. The system automatically transitions to the next vertical waypoint.

Miscellaneous Message Advisories (Cont.)

Message	Comments
VNV – Unavailable. Excessive track angle error.	The current track angle error exceeds the limit, causing the vertical deviation to go invalid.
VNV – Unavailable. Unsupported leg type in flight plan.	The lateral flight plan contains a procedure turn, vector, or other unsupported leg type prior to the active vertical waypoint. This prevents vertical guidance to the active vertical waypoint.
VNV – Unavailable. Excessive crosstrack error.	The current crosstrack exceeds the limit, causing vertical deviation to go invalid.
VNV – Unavailable. Parallel course selected.	A parallel course has been selected, causing the vertical deviation to go invalid.
NON WGS84 WPT – Do not use GPS for navigation to -[xxxx]	The position of the selected waypoint [xxxx] is not calculated based on the WGS84 map reference datum and may be positioned in error as displayed. Do not use GPS to navigate to the selected non-WGS84 waypoint.
TRAFFIC FAIL – Traffic device has failed.	The system is no longer receiving data from the traffic system. The traffic device should be serviced.
NON WGS84 WPT – Do not use GPS for navigation to-[xxxx]	The position of the selected waypoint [xxxx] is not calculated based on the WGS84 map reference datum and may be positioned in error as displayed. Do not use GPS to navigate to [xxxx].
STRMSCP FAIL – Stormscope has failed.	Stormscope has failed. The G1000 system should be serviced.
MAG VAR WARN – Large magnetic variance. Verify all course angles.	The GDU's internal model cannot determine the exact magnetic variance for geographic locations near the magnetic poles. Displayed magnetic course angles may differ from the actual magnetic heading by more than 2°.
SVS – SVS DISABLED: Out of available terrain region.	Synthetic Vision is disabled because the aircraft is not within the boundaries of the installed terrain database.
SVS – SVS DISABLED: Terrain DB resolution too low.	Synthetic Vision is disabled because a terrain database of sufficient resolution (9 arc-second or better) is not currently installed.
SCHEDULER [#] – <message>.	Message criteria entered by the user.
CHECK CRS – Database course for LOC1 / [LOC ID] is [CRS]°.	Selected course for LOC1 differs from published localizer course by more than 10 degrees.
CHECK CRS – Database course for LOC2 / [LOC ID] is [CRS]°.	Selected course for LOC2 differs from published localizer course by more than 10 degrees.

Miscellaneous Message Advisories (Cont.)

Message	Comments
[PFD1 or MFD1] CARD 1 REM – Card 1 was removed. Reinsert card.	The SD card was removed from the top card slot of the PFD or MFD. The SD card needs to be reinserted.
[PFD1 or MFD1] CARD 2 REM – Card 2 was removed. Reinsert card.	The SD card was removed from the bottom card slot of the PFD or MFD. The SD card needs to be reinserted.
[PFD1 or MFD1] CARD 1 ERR – Card 1 is invalid.	The SD card in the top card slot of the PFD or MFD contains invalid data.
[PFD1 or MFD1] CARD 2 ERR – Card 2 is invalid.	The SD card in the bottom card slot of the PFD or MFD contains invalid data.
TRN AUD FAIL – Trn Awareness audio source unavailable.	The audio source for terrain awareness is offline. Check GIA1 or GIA 2.
TERRAIN AUD CFG – Trn Awareness audio config error. Service req'd.	Terrain audio alerts are not configured properly. The system should be serviced
REGISTER GFDS – Data services are inoperative, register w/GFDS.	The GSR 56 is not registered with Garmin Flight Data Services, or its current registration data has failed authentication.

13.10 FLIGHT PLAN IMPORT/EXPORT MESSAGES

In some circumstances, some messages may appear in conjunction with others.

Flight Plan Import/Export Results	Description
'Flight plan successfully imported.'	A flight plan file stored on the SD card was successfully imported as a stored flight plan.
'File contained user waypoints only. User waypoints imported successfully. No stored flight plan data was modified.'	The file stored on the SD card did not contain a flight plan, only user waypoints. These waypoints have been saved to the system user waypoints. No flight plans stored in the system have been modified.
'No flight plan files found to import.'	The SD card contains no flight plan data.
'Flight plan import failed.'	Flight plan data was not successfully imported from the SD card.
'Flight plan partially imported.'	Some flight plan waypoints were successfully imported from the SD card, however others had errors and were not imported. A partial stored flight plan now exists in the system.
'File contained user waypoints only.'	The file stored on the SD card did not contain a flight plan, only user waypoints. One or more of these waypoints did not import successfully.

Flight Plan Import/Export Results	Description
'Too many points. Flight plan truncated.'	The flight plan on the SD card contains more waypoints than the system can support. The flight plan was imported with as many waypoints as possible.
'Some waypoints not loaded. Waypoints locked.'	The flight plan on the SD card contains one or more waypoints that the system cannot find in the navigation database. The flight plan has been imported, but must be edited within the system before it can be activated for use.
'User waypoint database full. Not all loaded.'	The flight plan file on the SD card contains user waypoints. The quantity of stored user waypoints has exceeded system capacity, therefore not all the user waypoints on the SD card have been imported. Any flight plan user waypoints that were not imported are locked in the flight plan. The flight plan must be edited within the system before it can be activated for use.
'One or more user waypoints renamed.'	One or more imported user waypoints were renamed when imported due to naming conflicts with waypoints already existing in the system.
'Flight plan successfully exported.'	The stored flight plan was successfully exported to the SD card.
'Flight plan export failed.'	The stored flight plan was not successfully exported to the SD card. The SD card may not have sufficient available memory or the card may have been removed prematurely.

A

Abnormal COM operation 12-2
 Activate a flight plan 8-4
 Active channel 11-16
 Active database 1-14
 Active flight plan 8-4
 Active Navigation Database 1-14
 ADF 1-7, 5-3
 ADS-B RR-2, 10-12, 10-14, 13-7
 AFCS 13-4
 Age 10-7
 AHRS 13-21, 13-22
 Aircraft alerts 13-3
 AIRMET 10-5
 Airport frequency 7-29
 Airport information 7-25
 Airspace alerts 7-33
 Airspeed indicator 2-3
 Airspeed Reference 6-8
 Airspeed trend vector 2-3
 Airways 8-7
 Alerting system 13-1
 Alerts 13-1
 Alert levels 13-2
 Alert Pop-Up 10-24
 ALT 1-4, 1-8, 2-4, 6-4, 6-6, 6-13, 7-22, 10-13
 Altitude alerting 2-4
 Altitude constraints 1-11
 Altitude hold 1-4
 Altitude Hold Mode 6-6
 Altitude mode 10-13
 Altitude Reference 6-6, 6-13
 Altitude restrictions 1-12
 Altitude trend vector 2-4
 Altitude volume 10-13
 ALT Knob 1-4
 Ammeter 3-3, 3-9
 AOPA Airport Directory 11-15
 AP 1-4, 13-4
 Approach
 ILS 6-31
 Missed 6-33

WAAS 6-32
 Approaches 9-2
 Approach activation 4-4
 Approach markers
 Signal augmentation 5-2
 Approach Mode 6-20
 Approach Mode, AFCS 6-31, 6-32
 AP DISC Switch 6-1, 6-34
 Arrival procedure 7-12, 7-14, 7-20
 Arrivals 9-1
 Assist 3-4, 3-6, 3-7
 Attitude indicator 2-3
 Audio alerting system 13-1
 Audio panel 4-3, 5-1
 Audio Panel controls
 SPKR 5-2
 Audio panel controls
 ADF 5-3
 DME 5-3
 NAV1 5-3
 NAV2 5-3
 Aural alerts 13-7
 Automatic audio muting 11-18
 Autopilot 13-4
 Auto-tuning 4-4
 Automatic Flight Control System (AFCS)
 Status Annunciations 6-34
 Status Box 6-2
 Automatic squelch 4-3
 Autopilot 6-22–6-23
 Autopilot disconnect 6-16, 6-23
 Auxiliary video 11-24

B

Backcourse Mode 6-21
 Barometric minimum 2-8
 Base reflectivity 10-4
 BRG1 2-11
 BRG2 2-11

C

CAUTION 13-2
 CDI 2-9, 2-11, 7-3, 7-6, 7-14, 7-19,

7-23, 9-2, 13-23

Cell 10-2
 Cell mode 10-2
 Cell movement 10-5
 Chart Not Available 11-12, 11-15
 Chart options 11-12, 11-15
 ChartView 11-11
 ChartView functions 11-11
 ChartView plan view 11-12
 ChartView softkeys 11-11
 Checklists 11-20–11-21
 Checklist softkeys 11-20
 Cloud Tops 10-4
 CLR 1-3, 3-9
 Coast mode 10-12
 Code selection 4-5
 Command Bars, flight director 6-2
 COM frequency window 4-1
 COM Knob 4-3
 Controls 1-2
 Control Wheel Steering (CWS) 6-23
 Create a new user waypoint 8-1
 CWS Button 6-1–6-23
 Cyclones 10-5
 Cylinder Head Temperature 3-1, 3-4

D

Data logging 11-24
 Day/Night views 11-13, 11-15
 Day view 11-13, 11-15
 DB Mismatch 1-13, 1-15
 Dead Reckoning 2-12, 12-3, 13-9
 Departures 9-1
 Direct-to 7-1, 7-2, 7-3, 7-4, 7-5, 7-12, 7-14, 7-23, 8-11
 DME 1-7
 DR 2-12
 DR mode 12-3, 12-4
 Dual CDU failure 12-2

E

ECHO TOPS 10-4
 Edit a flight plan 8-9

EDR 10-23
 Electronic checklists 11-20, 11-21, 11-22
 Emergency checklist 11-21
 Engine Hours 3-3, 3-8
 Engine Leaning 3-6
 Engine Page 3-1
 Excessive Descent Rate 10-23
 Exhaust Gas Temperature 3-2, 3-4

F

FD 1-4, 13-4
 FIS-B Weather 10-7, 10-8, 10-9, 10-10, 10-11
 Five-Hundred Aural Alert 10-24
 FLC 1-4
 Flight director 6-2–6-3
 Pitch modes 6-3–6-9
 Roll modes 6-17–6-19
 Flight ID 4-5
 Flight level change 1-4
 Flight Level Change Mode 6-28, 6-30
 Flight Level Change Mode (FLC) 6-8
 Flight plan import/export messages 13-26
 Flight Plan Catalog 9-1, 9-2
 FliteCharts 11-14
 FliteCharts functions 11-14
 FLTA 10-20, 10-23
 Forward Looking Terrain Avoidance 10-20, 10-23
 FPA 7-17
 Freezing level 10-5
 Frequency toggle key 1-3, 4-3
 Fuel
 Calculations 3-7
 Flow totalizer 3-7
 Remaining 3-9
 Used 3-8
 Fuel Flow 3-1, 3-3, 3-4, 3-8
 Fuel Quantity 3-2, 3-4, 3-9

G

GA Switch (Go-Around) 6-1
 Glidepath 2-2, 2-6, 7-22
 Glidepath Mode 6-14, 6-20
 Glidepath Mode (GP) 6-32
 Glideslope 2-6, 7-22
 Glideslope Mode 6-15, 6-20
 Glideslope Mode (GS) 6-31
 GMA 1347 1-1
 Go Around Mode (GA) 6-16, 6-33–6-34

H

Heading indication 2-9
 Heading Select 1-3, 1-4
 Heading Select Mode 6-18
 Heading Select Mode (HDG) 6-25
 Headset(s) 5-3
 Horizontal situation indicator 2-8
 HSI 2-8
 Hurricanes 10-5

I

ID RR-1, 1-3, 4-2, 4-3
 IDENT function 4-5
 ILS approach 6-31
 Imminent Terrain Impact 10-20, 10-23
 Impact point 10-20, 10-23
 Inhibit 10-20, 10-22
 Interrogations 4-5
 IOI 10-18, 10-20, 10-23, 10-25, 13-5, 13-6
 ITI 10-20, 10-23

K

Key(s) 1-4

L

Lean Display 3-5, 3-6
 Leaning 3-7
 Leaning, Engine 3-4
 Lean Display 3-1, 3-4, 3-6
 Lighted obstacle 10-20, 10-24

Lightning 1-6, 1-9, 10-2, 10-4
 LNAV 2-6, 7-5
 Load approach 8-9
 Load a VOR frequency 7-31
 Load departure 8-8
 Loading Updated Databases 1-13
 Load the frequency for a controlling agency 7-33
 Load the nearest ARTCC frequency 7-32
 LOI 2-11
 LOW ALT 2-5
 Low Altitude 2-5
 LPV 2-6, 7-5, 7-23
 LPV approach 6-24

M

Magnetic Field Variation Database Update 1-15
 Manifold Pressure 3-1, 3-3, 3-4, 3-6, 3-7, 3-9
 Manual Electric Trim (MET) 6-22
 MAP 7-1
 Map panning 10-5
 Marker beacon 2-7
 Message advisories 13-11–13-25
 MET 13-4
 METAR 10-3, 10-5
 Metric display 2-4
 MET Switch (Manual Electric Trim) 6-1
 MFD 1-1, 4-4
 Minimums 13-7
 Missed approach 6-33
 Missed Approach 7-5, 7-23
 Mistrim 13-4
 MKR/MUTE 5-2, 5-4
 Mode S 4-4
 Mode selection softkeys 4-5
 Morse code identifier 4-3

N

Nav/Com controls 4-1
 NAV1 5-3

NAV2 5-3
 Navigation 7-1
 Navigation database 1-11, 1-12
 Navigation Mode 6-19–6-20
 Navigation Mode, AFCS 6-26–6-27
 Navigation status window 2-2
 NAV frequency window 4-1
 NCR 10-23
 Nearest Airports Page 7-25, 7-29,
 7-30, 7-31, 7-32, 7-33, 8-1
 Nearest ARTCC & FSS frequencies 7-32
 Negative Climb Rate After Takeoff
 10-23
 NEXRAD 10-3, 10-4, 10-7, 10-11
 NEXRAD Softkey 10-10
 Non-path descent 6-13, 6-30–6-31

O

OBS 2-12
 Obstacles 10-15, 10-20, 10-24, 13-13,
 13-18
 Oil Pressure 3-1, 3-7
 Oil Temperature 3-1, 3-8
 Operation 5-2
 Optional
 NAV radios 4-3
 Overspeed protection, autopilot 6-35

P

Page group icon 1-10
 Passenger address 5-2
 PA annunciator 5-2
 PA system 5-2
 PDA 10-23
 Peak, Cylinder 3-7–3-8
 Peak temperature 3-4, 3-7
 PFD 1-1, 4-1, 4-4
 Pitch hold 1-4
 Pitch Hold Mode (PIT) 6-5
 Pitch modes, flight director 6-3–6-9
 Pitch Reference 6-5
 Power-up page 11-20
 Premature Descent Alert 10-23

Presets 11-17
 Procedure examples, AFCS 6-24–6-31

R

Red pointer 2-3
 Remove departure, arrival, or approach
 8-9
 Replies 4-5
 Required Vertical Speed 2-6, 7-18
 Required Vertical Speed Indicator 7-18
 Reversionary mode 5-1, 12-1
 ROC 10-18, 10-20, 10-23, 10-25,
 13-5, 13-6
 Roll Hold Mode (ROL) 6-17
 Roll modes, flight director 6-17–6-20
 Roll Reference 6-18
 RTC 10-20, 10-23
 RVSI 7-18
 RX indicator 4-3
 R indication 4-5

S

SBAS 1-11, 2-2, 2-5, 2-6, 2-9, 2-10,
 6-3, 6-14, 6-20, 6-24, 7-5,
 7-17, 9-2, 10-20, 10-22, 11-23,
 12-3, 13-18, 13-19
 Scheduler 11-18
 Secure Digital (SD) card 11-20
 Selected Altitude 6-6, 6-10, 6-13
 Selected Altitude Capture Mode 6-6,
 6-10, 6-13
 Selected Course 6-20, 6-21
 Selected Heading 6-18
 Selected vertical speed 2-7
 Servos 6-22
 Severe thunderstorm 10-5
 SIGMET 10-5
 Slip/Skid indicator 2-3
 Softkey function (MFD) 1-5, 1-9
 Speaker 5-2
 Speed ranges 2-3
 SQ 1-3, 4-2, 4-3, 5-1, 5-4
 Squelch 5-4

Standby Navigation Database 1-15
 STBY Softkey 4-4
 Store Flight Plan 8-9
 Stormscope lightning data 1-6, 1-9,
 10-1, 10-2
 Strike 10-2
 Strike mode 10-2
 SVS 13-25
 Synchronization 1-14
 SYNC Status 1-15
 System annunciations 13-1
 System message advisories 13-10

T

TA 10-12, 13-7
 Tachometer 3-1, 3-4, 3-7
 TAF 10-3, 10-11
 TAS 10-12, 10-13, 10-14, 13-21
 TAWS 10-16, 10-21, 10-22–10-26,
 13-6
 TAWS-B 10-21
 TAWS system test 10-23
 Temperature
 Peak Cylinder 3-7
 Turbine Inlet 3-7
 Terrain 10-15, 10-16, 10-26, 12-2,
 13-13
 Terrain 10-15, 10-16, 10-21, 10-24
 Terrain-SVS 10-16, 10-17, 10-20, 10-
 21, 11-1, 11-8, 13-5
 TFR 10-5
 Timer 13-23
 TIS 10-12
 TNA Mute 10-12
 TOD 7-17, 7-18, 7-21
 Top of Descent 7-17, 7-18
 Tornado 10-5
 Traffic advisory 10-12, 10-13, 10-14,
 10-26
 Traffic Advisory 13-7
 Traffic map page 10-21
 Traffic map page 10-12– 10-16, 10-24
 Transponder 4-4

Transponder standby mode 4-4
 Transponder Status bar 4-5
 Trim adapter 6-22
 Tropical storms 10-5
 Turbine Inlet Temperature 3-2, 3-4, 3-7
 Turbine Inlet Temperature (TIT) 3-7
 TX 4-3, 7-25

U

Unable to display chart 11-12, 11-15
 Unlighted obstacle 10-20, 10-24

V

Vacuum Pressure 3-2, 3-8
 VDI 7-18
 Vertical Deviation 2-2, 2-6
 Vertical deviation guidance 1-11, 1-12
 Vertical Deviation Indicator 7-18
 Vertical navigation 1-11, 1-12
 Vertical Navigation flight control 6-10–6-14
 Vertical Path Tracking Mode 6-10–6-11, 6-29
 Vertical speed 1-4, 2-7
 Vertical Speed Bug 2-7
 Vertical speed guidance 1-11, 1-12
 Vertical Speed Mode 6-7
 Vertical Speed Reference 6-7
 Vertical track 13-7
 VHF 4-1
 Video 11-24
 VNAV 1-12, 7-1, 7-2, 7-3, 7-4
 VNAV Target Altitude 6-10–6-13
 VNAV Target Altitude Capture Mode 6-13
 VNV 1-11, 1-12, 7-17, 13-24
 VOL/PUSH ID 4-2
 VOL/PUSH SQ 4-2, 4-3
 Voltmeter 3-3, 3-9
 Volume/squelch 5-4
 VS 1-4
 VSI 7-18
 Vspeeds 2-3
 VS TGT 7-17

W

WAAS 2-6, 6-24
 WARN 2-11, 2-12
 WARNING 13-2
 Weather data link page 10-4
 Weather product symbol 10-6
 Weather warnings 10-5
 Wind direction 10-5
 Wind speed 10-5
 Wings level 6-16, 6-18

X

XM radio 11-16
 XM radio volume 11-18
 XM satellite radio 11-16

Z

Zoom Window 11-26



Garmin International, Inc.
1200 East 151st Street
Olathe, KS 66062, U.S.A.
p: 913.397.8200 f: 913.397.8282

Garmin AT, Inc.
2345 Turner Road SE
Salem, OR 97302, U.S.A.
p: 503.391.3411 f: 503.364.2138

Garmin (Europe) Ltd
Liberty House, Bulls Copse Road
Hounslow Business Park
Southampton, SO40 9RB, U.K.
p: 44/0870.8501241 f: 44/0870.8501251

Garmin Corporation
No. 68, Jangshu 2nd Road
Shijr, Taipei County, Taiwan
p: 886/2.2642.9199 f: 886/2.2642.9099

www.garmin.com